

# HYDRO:EVOLVED

USER MANUAL

VERSION 3.06



*Page intentionally left blank.*

Date	Version	Summary of Changes
June 18, 2026	3.06	<ul style="list-style-type: none"> <li>· Added the Emergency Stop input.</li> <li>· Added the Fault Lamp and Car Stopped Lamp outputs.</li> <li>· Added the Emergency Stop fault.</li> <li>· Reviewed the fault names for F67-F74, F805, and F806.</li> <li>· Added the ELGO Landing System to the Controller Package Contents tab.</li> <li>· Reviewed the Valve Board Select DIP Switch settings under the Controller Hardware tab</li> </ul>
December 19, 2025	3.05	<ul style="list-style-type: none"> <li>· Deleted the Floor Level Adjustments tab and moved its contents to the Installation Guide.</li> <li>· Reviewed the Installation Guide.</li> <li>· Deleted the Emergency Tape Break Switch Assembly from the SmartPositioning Landing System section under the Landing System tab.</li> <li>· Deleted the Enable Pit Inspection section and added it to the Inspection Mode section under the Features and Modes of Operation tab.</li> <li>· Reviewed the Single Group Operation section under the Emergency Power section in the Features and Modes of Operation tab.</li> <li>· Arranged the types of inputs and outputs in alphabetical order.</li> <li>· Added a new tab with two new sections – List of Abbreviations and References.</li> </ul>
October 24, 2025	3.04	<ul style="list-style-type: none"> <li>· Reviewed the Set Up Construction Mode section.</li> <li>· Deleted alarms 160, 175, 190, and 205.</li> </ul>
October 10, 2025	3.03	<ul style="list-style-type: none"> <li>· Added new sections to the Features and Modes of Operation tab: Independent Service, Battery Power, Emergency Recall, Low Pressure, Motor Overheat, Phase Fault, Terminal Express.</li> <li>· Reviewed the Floor Level Adjustment tab.</li> <li>· Reviewed the list of Alarms and Faults.</li> </ul>
August 18, 2025	3.02	<ul style="list-style-type: none"> <li>· Replaced category-based lists of faults and alarms with single number-based lists.</li> </ul>
August 4, 2025	3.01	<ul style="list-style-type: none"> <li>· Added the Car Call Sequential Step Scanning under the Features and Modes of Operation tab.</li> <li>· Added the Auto Mode Generic Output under the Types of Outputs subsection.</li> </ul>
July 23, 2025	3.0	<ul style="list-style-type: none"> <li>· Visual and structural redesign of the manual.</li> </ul>
May 5, 2025	2.03	<ul style="list-style-type: none"> <li>· Reviewed the flow charts in the Sequence of Operation section.</li> </ul>
April 14, 2025	2.02	<ul style="list-style-type: none"> <li>· Reviewed the Timed Hall Call Security subsection under the Floors section.</li> <li>· Reviewed the Types of Inputs subsection under the Assigning Inputs and Outputs section.</li> </ul>
April 3, 2025	2.01	<ul style="list-style-type: none"> <li>· Reviewed the Bank B DIP Switch Setting table under Controller Hardware section.</li> </ul>

Date	Version	Summary of Changes
		<ul style="list-style-type: none"> <li>Reviewed the Inspection Run Options and Adjustments subsection under the Inspection Mode section.</li> <li>Reviewed the Learning the Hoistway section.</li> <li>Reviewed the Leveling Speed subsection under the Speeds section.</li> <li>Reviewed the faults under Doors, Safety, and Speed subsections.</li> </ul>
March 24, 2025	2.0	<ul style="list-style-type: none"> <li>Removed Traction-related details.</li> </ul>
February 25, 2025	1.15	<ul style="list-style-type: none"> <li>Added the Short Floor section.</li> </ul>
January 30, 2025	1.14	<ul style="list-style-type: none"> <li>Reviewed the Types of Inputs subsection under the Assigning Inputs and Outputs section.</li> <li>Reviewed the Disable DOB Rear subsection under the Doors section.</li> <li>Reviewed the Enable Pit Inspection subsection under the Miscellaneous section.</li> <li>Reviewed the Fixed CAM subsection under the Doors section.</li> <li>Reviewed the Setup subsection under the Menu Structures section.</li> </ul>
January 29, 2025	1.13	<ul style="list-style-type: none"> <li>Added the Smartrise Air Mobile Application subsection under the Miscellaneous section.</li> </ul>
January 20, 2025	1.12	<ul style="list-style-type: none"> <li>Added the BYPASS WANDERGUARD NEXT CC input under the Types of Inputs subsection.</li> <li>Added the HOISTWAY LAMP &amp; AT LANDING LAMP outputs under the Types of Outputs subsection.</li> <li>Reviewed the Direction Counter Limit subsection under the Miscellaneous section.</li> </ul>
November 5, 2024	1.11	<ul style="list-style-type: none"> <li>Added the Sequence of Operation section.</li> </ul>
September 9, 2024	1.10	<ul style="list-style-type: none"> <li>Added the BYPASS LWD input under the Types of Inputs subsection.</li> </ul>
August 23, 2024	1.9	<ul style="list-style-type: none"> <li>Added the Split Group Masks subsection to the Hall Network section.</li> <li>Added a note on short floor to the Sensory Array Assembly subsection under the SmartPositioning Landing System section.</li> <li>Added a note on short floor to the Proximity Sensor Assembly subsection under the NEMA 4 Landing System section.</li> </ul>
June 17, 2024	1.8	<ul style="list-style-type: none"> <li>Replaced “S-curve” with “Digital S-curve Technology™ (U.S. Patent Pending)”.</li> </ul>
June 3, 2024	1.7	<ul style="list-style-type: none"> <li>Updated the CPLD subsection under the Status section.</li> </ul>
May 27, 2024	1.6	<ul style="list-style-type: none"> <li>Updated the Logged Faults and Logged Alarms subsections.</li> <li>Added the Active Shooter output.</li> <li>Added the Clear Latched Calls input.</li> </ul>
May 20, 2024	1.5	<ul style="list-style-type: none"> <li>Added the Replay Feature subsection to the Miscellaneous section.</li> </ul>

Date	Version	Summary of Changes
April 17, 2024	1.4	<ul style="list-style-type: none"> <li>· Updated document presentation.</li> <li>· Validated &amp; updated the menu structures, LCD displays, tables, document content.</li> <li>· Replaced the “Overview” title with “List of Hydro:Evolved Manuals”.</li> <li>· Added the NEMA 4 Landing System section.</li> <li>· Added the Timed Hall Call Security subsection to the Floors section.</li> <li>· Added the Third Valve Board subsection under the Hydro section.</li> <li>· Added the Fourth Valve Board subsection under the Hydro section.</li> <li>· Added the Third subsection to the Soft Starter subsection (under the Hydro section).</li> <li>· Added the Viscosity subsection under the Hydro section.</li> <li>· Added the Low Oil subsection under the Hydro section.</li> <li>· Added the Enable Pit Inspection subsection under the Miscellaneous section.</li> <li>· Added the Lockout Passcode subsection to the Miscellaneous section.</li> <li>· Added the Direction Counter Limit subsection to the Miscellaneous section.</li> <li>· Added the Reset Service subsection to the Miscellaneous section.</li> <li>· Added the Speed Deviation subsection under the Safety section. Added the Ph1 Recall Floor subsection to the EMS subsection (under the Emergency section).</li> <li>· Added the Hall Medical Rear Door Mask subsection to the Hall Network section.</li> <li>· Added the Load Weighing Device section.</li> <li>· Added the Dynamic Security subsection to the Virtual Inputs subsection (under the Status section).</li> <li>· Added the List of Faults subsection to the Faults section.</li> <li>· Added the List of Alarms section to the Alarms section.</li> <li>· Added the List of Abbreviations section.</li> <li>· Added the References section.</li> <li>· Updated the Construction Mode section.</li> <li>· Updated the Wander Guard section.</li> <li>· Updated the EMS section.</li> <li>· Updated the Access Code section.</li> </ul>
October 1, 2022	1.3	<ul style="list-style-type: none"> <li>· Updated Hydro Slowdown.</li> </ul>
July 21, 2022	1.2	<ul style="list-style-type: none"> <li>· Updated Adaptive Slowdown™ system (U.S. Patent Pending).</li> </ul>
October 20, 2021	1.1	<ul style="list-style-type: none"> <li>· Added the 24 Input Board section.</li> </ul>
September 9, 2021	1.0	<ul style="list-style-type: none"> <li>· Initial Release.</li> </ul>

*Page intentionally left blank.*

<b>SEQUENCE OF OPERATION</b> .....	<b>1</b>
1 Overview.....	2
2 Car Movement.....	2
3 Door Operation.....	4
<b>CONTROLLER PACKAGE CONTENTS</b> .....	<b>7</b>
1 Two-Stop Hydro:Evolved Package Contents.....	8
<b>INSTALLATION GUIDE</b> .....	<b>15</b>
1 Review Job Specifications .....	16
2 Implement Safe and Effective Grounding .....	16
3 Review Voltage Settings.....	16
4 Mount Controller.....	16
5 Set Up Main Power.....	16
6 Set Up Soft Starter & Valves .....	17
6.1 Primary Soft Starter Configuration .....	17
6.1.1 Ramp Up Time .....	17
6.1.2 Vmax.....	18
6.1.3 Over Current .....	18
6.1.4 Over Temperature .....	19
6.2 Secondary Soft Starter Configuration .....	19
6.2.1 Enable Secondary.....	19
6.2.2 Ramp Up Time .....	20
6.2.3 Vmax.....	20
6.2.4 Over Current .....	20
6.2.5 Over Temperature .....	21
6.3 Third Soft Starter Configuration.....	21
6.3.1 Enable Third.....	21
6.4 Run with One Soft Starter Configuration .....	22
6.5 Valves Configuration .....	22
6.5.1 Valve Type Select.....	22
6.5.2 Secondary Valve Board .....	23
6.5.3 Third Valve Board .....	23
6.5.4 Fourth Valve Board.....	23
7 Set Up Construction Mode .....	24
8 Set Up Wiring.....	24
9 Mount Car Top.....	24
10 Set Up Normal Mode .....	24
11 Set Up Speeds .....	25
11.1 Contract Speed.....	25
11.2 Inspection Speed .....	25
11.3 Leveling Speed.....	26
11.4 Test Buffer Speed.....	26
12 Set Up Floors & Openings .....	27
13 Set Up Fire .....	27
14 Set Up Hall Board.....	27
15 Set Up Floor Levels.....	28
15.1 Primary Floor Level Adjustments .....	28
15.1.1 Maxton Valve Bypass Adjustment.....	28
15.1.2 Relevel Zone Size.....	31
15.1.3 Enable Releveling .....	31
15.1.4 Relevel Delay .....	31

15.1.5	Learn the Hoistway.....	32
15.1.6	Generate Speeds and Thresholds.....	33
15.1.7	Enable the Adaptive Slowdown System (U.S. Patent Pending).....	33
15.1.8	Floor Leveling Corrections.....	35
15.2	Fine-Tuning Floor Level Adjustments.....	36
15.2.1	Destination Offset Up.....	36
15.2.2	Destination Offset Down.....	37
15.2.3	Relevel Offset Up.....	37
15.2.4	Relevel Offset Down.....	38
15.2.5	Slowdown Offset Distance Up.....	38
15.2.6	Slowdown Offset Distance Down.....	39
15.2.7	NTS Debounce.....	40
15.2.8	TSRD Debounce Limit.....	40
15.2.9	TSRD Offset From NTS.....	41
<b>FAULTS &amp; ALARMS.....</b>		<b>43</b>
1	Faults.....	44
1.1	Active Faults.....	44
1.2	Logged Faults.....	44
1.3	Cleared Faults.....	44
1.4	List of Faults.....	45
2	Alarms.....	77
2.1	Active Alarms.....	77
2.2	Logged Alarms.....	77
2.3	Cleared Alarms.....	77
2.4	List of Alarms.....	77
<b>SYSTEM CONFIGURATIONS.....</b>		<b>103</b>
1	Adjusting Run Timers.....	104
2	Floors/Releveling.....	105
2.1	Short Floor Opening.....	105
2.2	Enable Releveling.....	105
2.3	Relevel Zone Size.....	105
2.4	Releveling Delay.....	105
3	Doors.....	105
3.1	Door Symbols.....	106
3.2	Control Doors.....	106
3.3	Door Dwell Timer.....	106
3.4	Hall Dwell Timer.....	107
3.5	ADA Dwell Timer.....	107
3.6	Hold Dwell Timer.....	107
3.7	Lobby Dwell Timer.....	107
3.8	Door Stuck Timer.....	108
3.9	Door Nudge Timer.....	108
3.10	Rear Doors.....	108
3.11	PreOpening Distance.....	108
3.12	DC On Run.....	109
3.13	DC On Close.....	109
3.14	DO On Open.....	109
3.15	Disable on CT Stop.....	109
3.16	Disable on HA.....	110
3.17	AT400 Doors.....	110

3.18	No Demand Doors Open.....	110
3.19	Jumper Timer .....	110
3.20	Jumper on DOL .....	111
3.21	Hourly Fault Limit.....	111
3.22	Nudge – Buzzer Only .....	111
3.23	Opening Time .....	111
3.24	Check Time .....	112
3.25	Door Type.....	112
3.26	Lock and CAM Timeout.....	112
3.27	Retiring CAM .....	113
3.28	Fixed CAM.....	113
3.29	Swing Lock GSW Timeout.....	113
3.30	Swing Contacts Timeout.....	113
3.31	Disable DOB Rear .....	114
3.32	Front Door State.....	114
3.33	Rear Door State.....	115
4	Car Data.....	115
4.1	Car Data Overview .....	115
4.2	Hall Call Mask Status.....	118
4.3	Opening Map Status.....	119
4.3.1	Front Opening Map Status.....	119
4.3.2	Rear Opening Map Status .....	119
4.4	Security Map Status .....	120
4.4.1	Front Security Map Status.....	120
4.4.2	Rear Security Map Status.....	120
4.5	Linked Hall Mask Status.....	121
4.6	Hall Security Map Status.....	122
4.6.1	Front Hall Security Map Status.....	122
4.6.2	Rear Hall Security Map Status .....	122
4.7	Hall Security Mask Status .....	123
4.8	Dispatching Timer Status .....	124
4.9	VIP Flags .....	125
4.10	VIP Masks.....	125
4.11	Car Call Enable Bitmap Status.....	126
4.11.1	Front Car Call Enable Bitmap Status .....	126
4.11.2	Rear Car Call Enable Bitmap Status .....	127
4.12	Emergency Medical Call Mask and Landing.....	128
5	Hall Network.....	129
5.1	CAN Bus.....	129
5.2	Hall Board Status .....	130
5.3	Hall Security Mask .....	131
5.4	Hall Security Map.....	131
5.5	Hall Security Status.....	132
5.6	Hall Call Mask.....	132
5.7	Linked Hall Buttons.....	133
5.8	Hall Medical Mask.....	133
5.9	Hall Medical Rear Door Mask.....	134
5.10	Hall Rear Door Mask .....	134
5.11	Split Group Masks.....	134

5.12	Errors .....	134
5.13	Compatibility.....	135
6	Serial Hall Lanterns.....	135
6.1	CAN BUS.....	135
6.2	Hall Lantern Masks .....	135
6.3	Serial Hall Lantern Status .....	135
7	Additional Hydro Settings .....	136
7.1	Battery Test Time.....	136
7.2	Jack Resync Time.....	136
7.2.1	Disable NTS Alarm .....	137
8	Slowdowns .....	137
8.1	Level Maximum Run Distance.....	137
8.2	NTS Buffer Distance Up and Down .....	137
8.3	Destination and Relevel Offsets.....	138
8.3.1	Destination Offset.....	138
8.3.2	Relevel Offset .....	138
8.4	Speed Thresholds .....	138
8.5	Slowdown Distance .....	139
8.6	Hydro Speed Setup .....	139
8.6.1	Car Overshooting .....	139
8.6.2	Adjust Leveling Time .....	140
8.7	Adaptive Slowdown™ system (U.S. Patent Pending).....	140
8.7.1	Procedure.....	140
8.7.2	Troubleshoot Adaptive Slowdown™ system (U.S. Patent Pending).....	140
8.7.3	Monitoring Adaptive Slowdown™ system (U.S. Patent Pending).....	141
8.8	Slowdown Distance After Adjustments .....	141
8.8.1	Overshooting.....	142
8.8.2	Extended Leveling Time (Steady State) .....	142
8.9	TSRD Distance .....	143
9	Miscellaneous.....	143
9.1	Bypass Term Limit .....	143
9.2	Enable Construction Box .....	143
9.3	Maximum Run Time .....	144
9.4	CT Insp. Req. IC.....	144
9.5	Dis. IdleTrvArrow .....	144
9.6	Enable Latches Car Calls.....	144
9.7	En. 3 Digit PI .....	145
9.8	Default .....	145
9.8.1	Default Floors.....	145
9.8.2	Default Run Timers.....	145
9.8.3	Default I/O.....	145
9.8.4	Default Other .....	146
9.8.5	Default Factory .....	146
10	Timers.....	146
10.1	Fan & Light Timer.....	146
10.2	External Fan Timer .....	147
10.3	Arrival Update Time.....	147
11	Safety.....	147
11.1	Speed Deviation .....	147

11.1.1	Timeout.....	147
11.2	Lock Clip .....	147
11.3	General ODL .....	148
11.4	NTS ODL .....	148
11.5	TSRD ODL .....	148
12	Status.....	148
12.1	Input Status.....	149
12.2	Output Status.....	149
12.3	Valves 1, 2, 3 & 4 Statuses .....	149
12.4	Soft Starter and Soft Starter 2 Status .....	150
12.5	Expansion Status .....	151
12.6	Riser Board Status .....	152
12.7	CPLD.....	152
12.8	E-Power Status .....	156
12.9	EMS Status.....	157
12.10	Hall Call Status .....	157
12.11	Virtual Inputs .....	157
12.11.1	Remote Commands .....	158
12.12	DIP Status .....	160
12.13	Door Status .....	160
13	Group Setup.....	160
13.1	Group Car Index .....	160
13.2	Group Landing Offset.....	160
13.3	Dispatch Timeout.....	161
13.4	Dispatch Offline Timeout .....	161
14	PI Labels .....	161
15	Real-Time Clock .....	161
15.1	Clock Status.....	162
16	Debug.....	162
16.1	View Debug.....	162
16.2	Enter Car Calls.....	164
16.3	Enter Hall Calls .....	164
16.4	Enter Door Command .....	164
16.5	View Network Packet .....	165
16.6	View Group Packet.....	165
16.7	Acceptance Test .....	165
16.8	Emergency Bitmap .....	165
16.9	Module Statuses .....	166
16.9.1	Motion Status .....	166
16.9.2	Pattern Data.....	166
16.9.3	Auto Status .....	166
16.9.4	Recall Status.....	166
16.9.5	Fire Status.....	166
16.9.6	Counterweight Status .....	166
16.9.7	Floor Learn Status .....	167
16.10	Car Destination .....	167
16.11	Run Counter .....	168
16.12	DebugRuns.....	168
16.12.1	Dwell Time.....	168

16.12.2	Terminal to Terminal.....	168
16.12.3	Floor to Floor .....	168
16.12.4	Random .....	169
16.12.5	Hall Random Runs.....	169
17	About .....	169
<b>FEATURES &amp; MODES OF OPERATION .....</b>		<b>171</b>
1	Floors / Security.....	172
1.1	Security Setting.....	172
1.2	Enable Hall Security.....	172
1.3	Access Code.....	172
1.3.1	Front Door Access Code .....	173
1.3.2	Disabling an Access Code .....	173
1.3.3	Additional Front / Rear Door Access Codes.....	174
1.3.4	Offset Floors .....	174
1.3.5	Car Call Button Timer.....	174
1.4	Timed Car Call Security .....	174
1.5	Timed Hall Call Security.....	175
1.6	Dynamic Security .....	176
2	Lockout Passcode.....	177
3	Payment Passcode .....	177
4	Parking .....	177
4.1	GUI Parking.....	178
4.2	Parking Timer.....	178
4.3	Parking Floor .....	178
4.4	Parking Door Open .....	178
5	Direction Counter Limit.....	179
6	Direction Change Delay .....	179
7	OOS.....	179
7.1	Disable OOS .....	179
7.2	Hourly Fault Limit.....	180
7.3	Maximum Starts Per Minute.....	180
7.4	Disable PI OOS.....	180
8	Reset Service .....	180
9	Replay Feature.....	181
10	Smartrise Air Mobile Application .....	181
11	Data Acquisition Device Unit .....	181
11.1	DAD Status.....	181
12	Cross Registration.....	182
12.1	XReg Cars.....	182
12.2	XReg Dest Timeout.....	182
12.3	XReg Dest Offline Timeout .....	183
12.4	XReg Destination.....	183
12.5	XReg Data .....	183
13	Construction Mode .....	184
14	Inspection Mode .....	184
14.1	Machine Room, CT, Hoistway Access, and Pit Inspections .....	184
15	Hoistway Access Mode .....	184
16	Car To Lobby Floor Mode .....	186
17	Wander Guard Mode.....	186
18	Sabbath Mode.....	186

18.1	Procedure to Set Sabbath Operation .....	186
19	Hydro Mode Settings.....	189
19.1	Viscosity Mode.....	189
19.1.1	Run Time.....	190
19.1.2	Rest Time.....	190
19.1.3	Cycles Allowed .....	190
19.1.4	Allow Calls.....	190
19.2	Low Oil Mode .....	190
20	VIP Mode.....	191
21	Active Shooter Mode.....	191
22	Marshal Mode .....	191
23	Swing Mode .....	192
23.1	Configuring Swing Mode Input.....	192
23.2	Calls Enable Swing.....	192
23.3	Swing Opening .....	192
23.4	Swing Call Mask .....	193
23.5	Stay Active in Group .....	193
23.6	Idle Timer .....	193
24	Emergency Power .....	193
24.1	Key Parameters .....	194
24.2	Emergency Power Inputs.....	194
24.3	Emergency Power Outputs.....	194
24.4	Operation Modes .....	195
24.4.1	Simplex Operation .....	195
24.4.2	Multiple Group Operation .....	195
24.5	Number of Active Cars .....	195
24.6	Setting the Priority Car .....	195
24.7	Pretransfer Stall Behavior.....	195
24.8	Privileged Modes .....	196
24.8.1	Fire Phase 1 and Phase 2 Operation .....	196
24.8.2	EMS Phase 1 and Phase 2 Operation.....	196
24.8.3	Cars in Manual Modes of Operation (Inspection States) .....	196
24.8.4	Independent/Attendant Service Operation .....	197
24.9	Intergroup Communication .....	197
25	Earthquake.....	197
25.1	Enable Earthquake .....	197
25.2	Set CW Position .....	197
25.3	Earthquake Status.....	198
26	Fire .....	198
26.1	Main Recall .....	198
26.1.1	Main Recall Floor .....	198
26.1.2	Main Recall Door .....	199
26.2	Alternate Recall.....	199
26.2.1	Alternate Recall Floor .....	199
26.2.2	Alternate Recall Door .....	199
26.3	Main Smoke .....	199
26.3.1	Main or Alternate .....	199
26.3.2	Flash Fire Hat.....	200
26.3.3	Shunt Trip.....	200

26.4	Alternate Smoke.....	200
26.4.1	Main or Alternate .....	200
26.4.2	Flash Fire Hat.....	201
26.4.3	Shunt Trip.....	201
26.5	Hoistway Smoke .....	201
26.5.1	Main or Alternate .....	201
26.5.2	Flash Fire Hat.....	201
26.5.3	Shunt Trip.....	202
26.6	MR Smoke .....	202
26.6.1	Main or Alternate .....	202
26.6.2	Flash Fire Hat.....	202
26.6.3	Shunt Trip.....	203
26.7	Recall Key .....	203
26.8	Pit Smoke .....	203
26.8.1	Main or Alternate .....	203
26.8.2	Flash Fire Hat.....	204
26.8.3	Shunt Trip.....	204
26.9	Alt Machine Room.....	204
26.9.1	Enable Alternate Machine Room .....	204
26.9.2	Hoistway 2 Smoke .....	204
26.9.3	MR 2 Smoke.....	205
26.10	Advanced Configs .....	206
27	Flood.....	207
27.1	Number of Floors .....	207
27.2	Okay to Run.....	208
27.3	Override Fire.....	208
28	Emergency Medical Service.....	208
28.1	AllowPh2WithoutPh1 .....	208
28.2	Exit Ph2 Any Floor .....	209
28.3	Fire Overrides Ph1 .....	209
28.4	Ph1 Exit Delay .....	209
28.5	Ph2 Exit Delay .....	209
28.6	Ph1 Recall Floor .....	210
29	Attendant.....	210
29.1	Dispatch Timeout.....	210
29.2	Buzzer Time.....	210
30	Car Call Sequential Step Scanning .....	211
31	Independent Service .....	211
32	Battery Power .....	211
33	Emergency Recall .....	212
34	Low Pressure .....	212
35	Motor Overheat.....	212
36	Phase Fault .....	212
37	Terminal Express.....	212
	<b>INPUTS &amp; OUTPUTS .....</b>	<b>213</b>
1	Assigning Inputs and Outputs .....	214
2	Adding an Input or Output .....	214
3	Removing an Input or Output .....	215
4	Types of Inputs.....	215
5	Types of Outputs.....	221

6	Invert Inputs .....	225
7	Invert Outputs .....	226
<b>CONTROLLER HARDWARE .....</b>		<b>227</b>
1	Controller Hardware Overview .....	228
2	MR Board (SR3032) .....	228
2.1	Navigation Buttons.....	230
2.2	24 VDC Power Source.....	230
2.3	EBRK Reset Button .....	231
2.4	Normal Terminal Stop .....	231
2.5	Network .....	231
2.6	120 VAC Inputs and Outputs (Factory) .....	231
2.7	24 VDC Inputs and Outputs .....	231
2.8	24 VDC Monitoring System .....	231
2.9	Safety String Inputs 120 VAC .....	232
2.10	120 VAC Inputs and Outputs (Field).....	232
2.11	Hall Lock Connections.....	233
2.12	Inspection Controls.....	233
2.13	Safety Relays .....	234
3	CT/COP Board SR3030.....	235
4	I/O Board/Riser Board SR3031 .....	237
4.1	Group Redundancy .....	239
5	24 Input Board SR3041 .....	239
6	Valve Board.....	242
7	Hall Board SR1060 .....	243
<b>LANDING SYSTEM.....</b>		<b>245</b>
1	SmartPositioning Landing System .....	246
1.1	Coded Tape .....	246
1.2	Sensor Assembly Installation.....	247
1.3	Upper Tape Mount Assembly .....	250
1.4	Tape Clip Assembly.....	252
1.5	Lower Tape Mount Assembly .....	255
1.6	Sensor Array Assembly .....	256
1.7	Fine Tune.....	259
1.8	Alignment.....	260
2	Short Floor .....	263
3	NEMA 4 Landing System.....	264
3.1	Proximity Sensor Assembly.....	264
3.2	Installation .....	266
3.2.1	Mounting Magnetic Tape in the Hoistway .....	266
3.2.2	Mounting the Sensor to the Car.....	266
3.2.3	Install Magnetic Tape Through Sensor.....	266
3.3	LEDs.....	267
<b>NEW BOARD INSTALLATION.....</b>		<b>269</b>
1	Overview.....	270
2	Retain Parameters for a Replaced MR Board .....	270
3	Retain Parameters for a Replaced CT or COP Board .....	270
<b>CONTROLLER MENU STRUCTURE.....</b>		<b>271</b>
1	Menu Structures .....	272
1.1	Status.....	272
1.2	Faults and Alarms .....	275

1.3	Setup.....	276
1.4	Debug.....	293
2	High-Level Navigation Menu Structure .....	295
2.1	Main Menu .....	295
2.2	Status.....	295
2.2.1	Inputs, Outputs, Valve Statuses .....	295
2.2.2	Soft Starter Statuses, Expansion Status .....	297
2.2.3	Riser Board Status, Hall Board Status, Hall Lantern Status .....	298
2.2.4	Hall Security Status, Hall Call Status, DAD Status.....	300
2.2.5	Clock, CPLD Status, Load Weigher Status.....	301
2.2.6	E-Power Status, EMS Status, Virtual Inputs .....	302
2.2.7	DIP Status, Door Status .....	305
2.3	Faults .....	306
2.4	Alarms.....	307
2.5	Setup.....	308
2.5.1	Setup I/O, Safety, Run Timers.....	308
2.5.2	Door Setup, Speeds, Floors .....	311
2.5.3	Hoistway Access, Fire, Earthquake .....	318
2.5.4	Miscellaneous, PI Labels, Real-Time Clock .....	322
2.5.5	Group Setup, Flood .....	325
2.5.6	EMS, Sabbath, Swing .....	328
2.5.7	Attendant, E-Power, Hydro.....	330
2.5.8	Access Code.....	336
2.6	Debug.....	337
2.6.1	Enter Car Calls, Enter Hall Calls, Enter Door Command .....	337
2.6.2	Edit Parameters, View Network Packet, View Group Packets .....	338
2.6.3	View Debug Data, Acceptance Test, EmergencyBitmap .....	339
2.6.4	Module Statuses, Car Data, Car Destinations.....	340
2.6.5	Run Counter, DebugRuns, XReg Destination.....	345
2.6.6	XReg Data, SH Dynamic Car Parking, SH Predictive Car Parking.....	347
2.6.7	SH Remote Commands, View Module Data .....	347
	<b>LIST OF ABBREVIATIONS &amp; REFERENCES .....</b>	<b>351</b>
	List of Abbreviations .....	352
	References.....	352

# SEQUENCE OF OPERATION

## 1 Overview

The information below provides a basic understanding of how Smartrise's hydro elevator controller system operates.

## 2 Car Movement

Movement of the elevator begins with the controller in the idle state. It remains in this state until a demand is entered into the system. The controller then begins the start of the run sequence. Once this is completed, the elevator car moves at a high speed until the slowdown point for the destination. The controller then switches the car to low speed until the destination is achieved. At that point, the end of the run sequence is initiated to bring the car to a full stop and return it to the idle state.

The idle state is the state in which the car remains stopped. The outputs controlling the valve board and soft starter are turned off. The controller remains in this state until a demand to move is entered into the system. The demand to move is usually a car call or a hall call entered by a passenger pressing a call button. A demand can also come from a special operation mode like fire service where a recall to the egress floor is initiated by a smoke sensor or manually by the Fire Phase 1 key switch. Regardless of what initiates the demand, the controller will determine the destination floor and switch to the start of run sequence.

The start of run sequence is the set of operations that are performed in order to transition the elevator from a stopped condition to that of being in motion. To move the car, the controller first commands the valves to open. If movement is in the upward direction, the soft starter is turned on; otherwise, it remains off.

As the car runs, the destination may change. This normally occurs when a call button is pressed for a floor located between the elevator's current position and the current destination. When this happens, the controller will determine if the new destination is achievable based on the elevator's speed, position, required slowdown distance, and location of the new demand. If the controller software determines that the new demand is achievable, the current destination is updated to the location of the new demand and the run continues. If the controller software determines that the demand is not achievable, then the car will continue to the original demand and answer the new demand when the car returns in the opposite direction. A programmable Slowdown Distance parameter tells the controller at what point it needs to drop out of high speed when approaching a destination. Since the Smartrise controller receives continuous position feedback from the landing system, there is no need for hoistway magnets or switches to perform slowdowns. All slowdowns are set electronically on the computer as a distance in feet and inches. When the elevator is less than this slowdown distance from the destination, the controller will automatically command the high speed valve to drop to move the car to low speed.

Once the car is at low speed, it begins looking for a Door Zone (DZ) magnet. Every floor in the building is marked with a single DZ magnet. When the elevator arrives at the magnet, the controller begins counting pulses from the landing system to detect how far into the magnet the car has travelled. During the controller installation, the floor level parameters were set, specifying how far from the bottom and top edges of the DZ magnet the car must travel. When these stop points are properly set, the car will stop at level with the floor. The programmed stop point for the floor will generally be a fraction of an inch before true floor level to allow time for the end of the run sequence to carry the car to the actual level position.

The end of the run sequence consists of stopping the car by turning off the valves and soft starter only if the elevator car was moving upward.

Once fully stopped, the car returns to the idle state where it awaits the next demand.

The flow chart below displays the sequence of operation for the car operation.

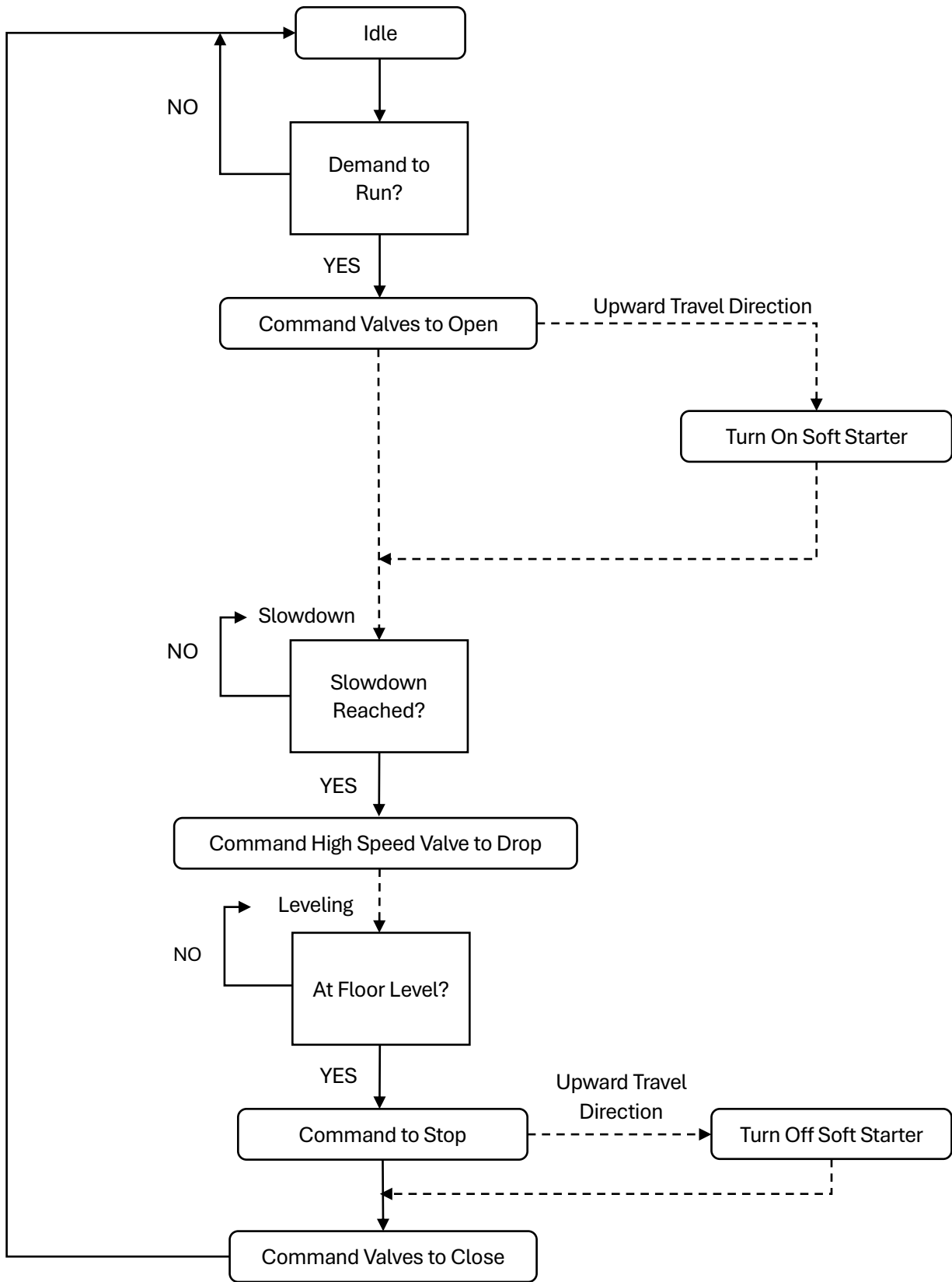

Figure 1: Car Movement

### 3 Door Operation

Door operation begins with the doors in the idle (closed) state. The doors remain in this state until an open request is received. The controller then initiates a door open signal to the door operator. This causes the doors to open. Once the doors are fully open, they remain in the dwell (fully opened) state until a close request is received. The controller then asserts the door close output to the door operator to cause the doors to close. Once the doors are fully closed, they return to the idle state.

In the idle state, the door outputs are normally off. When the car is running, the DC (Door Close) output is normally on. This provides power to keep the doors from accidentally opening due to vibrations as the car runs. This operation can be disabled using the “DC On Any Move” parameter on the controller’s Door Setup menu. The doors will remain in the idle state until a demand to open occurs.

A demand to open occurs either when the car arrives at a floor in response to a call or when the car is stopped at a floor and the Door Open Button or a Car call or Hall call at that floor is pressed. When this happens, the controller asserts the DO (Door Open) output to the door operator to open the doors. The DO output remains on until the doors are fully opened as indicated by the DOL (Door Open Limit) contact on the door operator. Once the doors are fully open, the DO output is removed, and the doors are in the dwell (fully opened) state.

The doors remain fully open in the dwell state until a demand to close is present. In normal operation, the demand to close occurs when the doors have been fully open for the Dwell Time specified under the Door Setup menu. The dwell time can be shortened if the Door Close Button is enabled and pressed. The dwell time can be extended if a Door Hold Button is present or if the controller has been programmed to park with the doors open. The Door Hold Button will extend the dwell time for a programmable number of seconds. The Park with Doors Open parameter will keep the doors open until a call demand is entered.

Once a demand to close occurs, the DC output will be activated, and the doors will close. While the doors are in the process of closing, several events can cause them to abort the close and reopen. These events include the pressing of the Door Open Button, a call button at the floor, or the Door Hold button. Additionally, an obstruction detected by the safety edge or photoeye will cause a reopen. When the door reopens, a reduced dwell time is normally used before an attempt to close is made once again. If the doors remain obstructed for an extended period of time, an optional parameter under the Door Setup menu allows the controller to attempt to nudge the doors closed. When nudging, the DC and ND (Nudge) outputs are asserted simultaneously to cause the doors to close at reduced torque. During this operation, the safety edge and photoeye are ignored as the controller attempts to clear the obstruction.

The door operation described so far has been for automatic opening and closing. There is also a mode for continuous pressure opening and closing. This is normally used during Fire Phase II and Independent Service. On Fire Phase II, the firefighter in the car must apply constant pressure on the Door Open Button to open the doors. If the button is released before the doors are fully open, the doors immediately reclose. Likewise, once the doors are fully open, constant pressure must be applied to the Door Close Button to close the doors. If the button is released before the doors are fully closed, they will reopen.

Independent Service utilizes the constant pressure door close operation but allows a Car Call Button to be used in place of the Door Close Button if desired. Opening of the doors on Independent Service is done automatically.

The flow chart below displays the sequence of operation for the door operation.

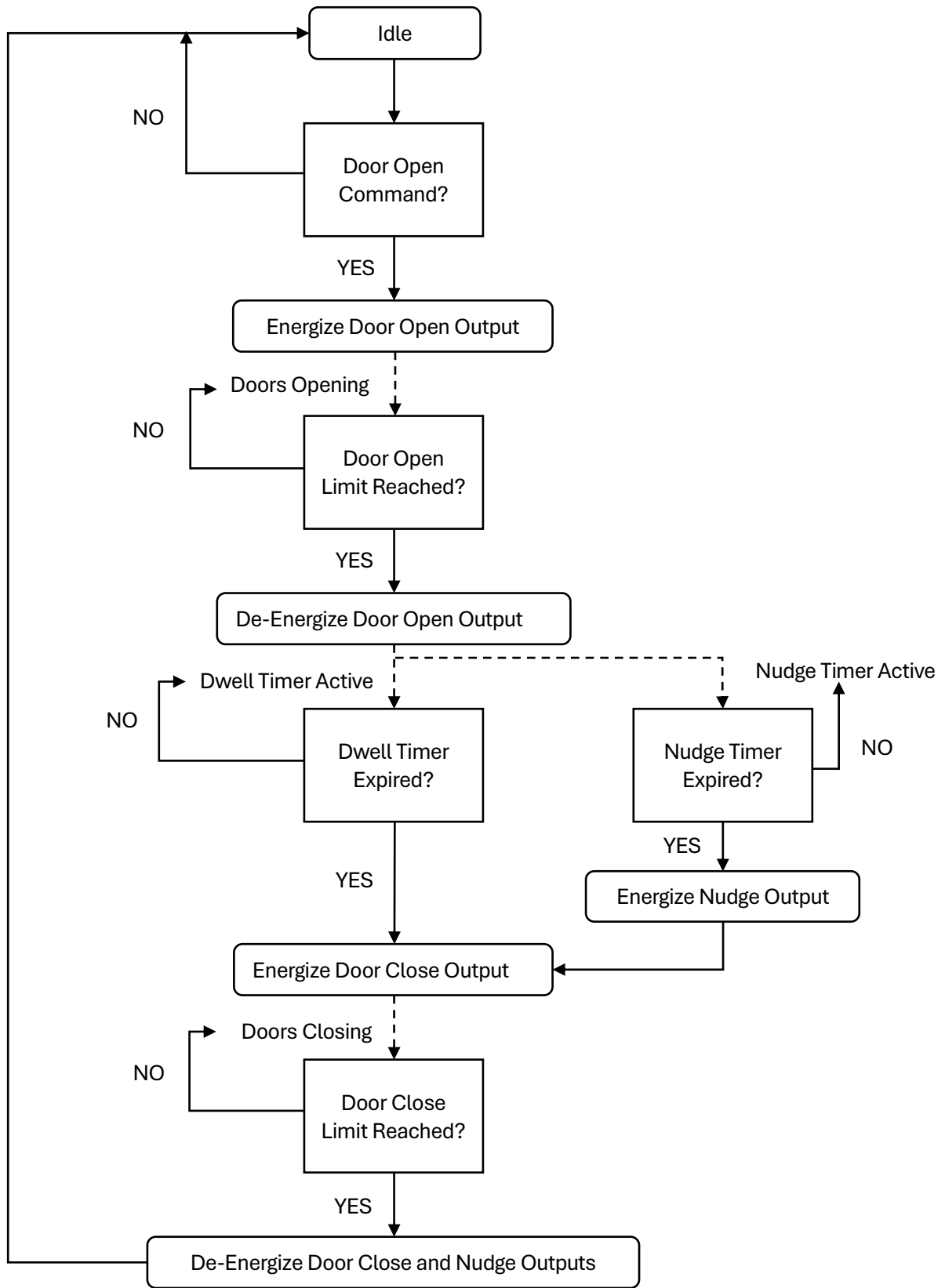

Figure 2: Door Operation

*Page intentionally left blank.*

---

# **CONTROLLER PACKAGE CONTENTS**

---

# 1 Two-Stop Hydro:Evolved Package Contents

This document outlines the components included in a standard two-stop Hydro:Evolved controller package from Smartrise.



Figure 3: Controller Package Sample Unboxed



Figure 4: Controller Hardware Sample Unboxed



Figure 5: Unistrut

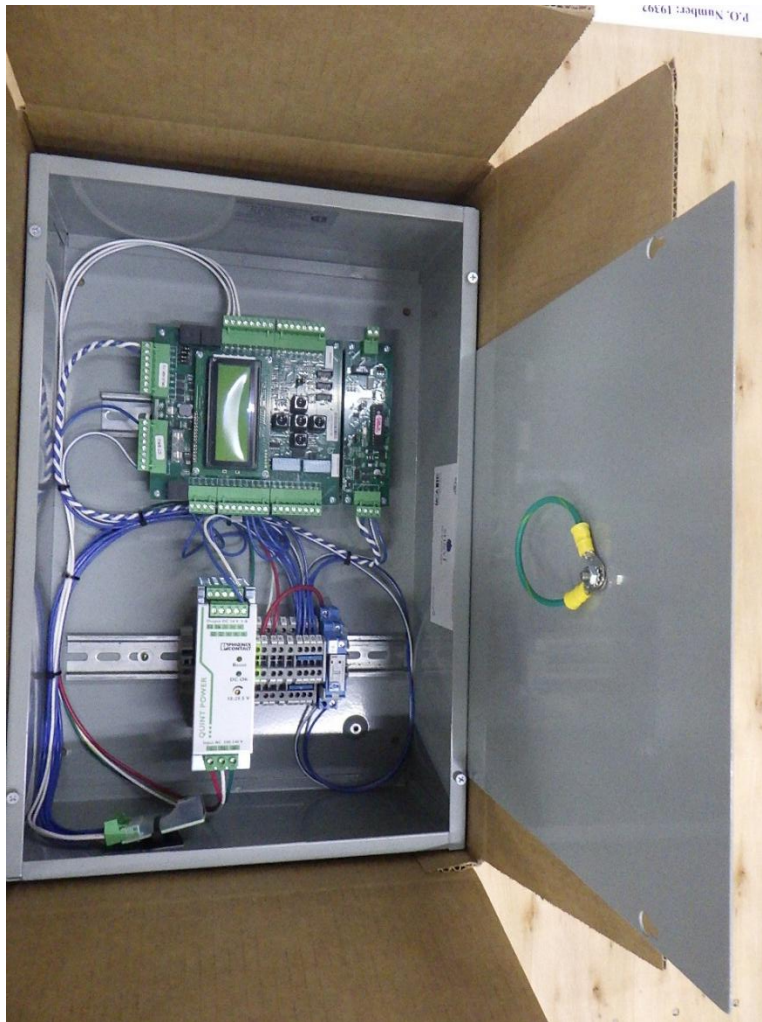

Figure 6: Controller Car Top



Figure 7: Inspection Box, Light Guard, 15ft CAT5



Figure 8: COP SRU Board



Figure 9: Enclosure Keys, USB, Hydro:Evolved User Manual, Soft Starter User Manual



Figure 10: Landing Tape Unboxed



Figure 11: Landing System Tape Hardware – DZ Blade, Camera, Extension, Upper & Lower Tape Mount, Landing System User Manual

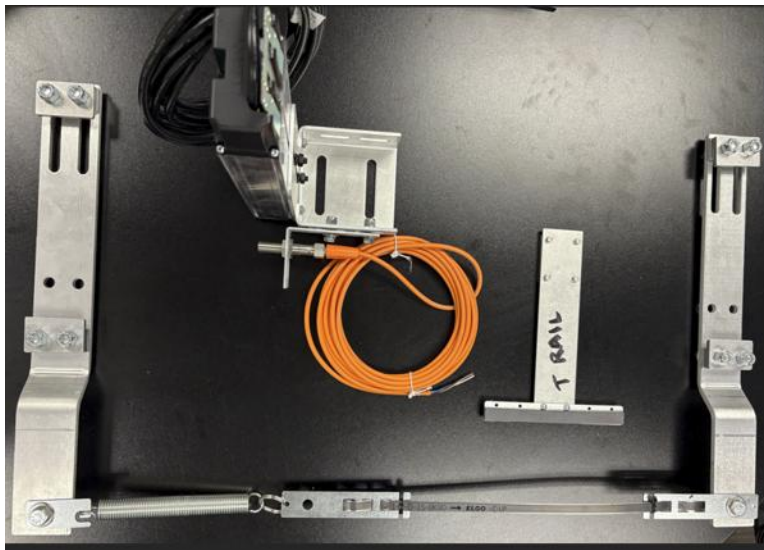

Figure 12: ELGO Landing System, T-Rail



Figure 13: CAT5 Package

*Page intentionally left blank.*

# INSTALLATION GUIDE

## 1 Review Job Specifications

Before beginning installation or configuration, it is essential to verify that all project documentation matches the controller and site requirements.

Refer to the job prints provided with the controller to ensure all specifications align with the project scope.

Be sure to verify the following on the **Hydro:Evolved Electrical Drawing**:

- **Job Name and Job Number** on the **Cover Sheet**.
- **Job Specifications** on the **Job Data Sheet**.

## 2 Implement Safe and Effective Grounding

A proper and effective ground connection is essential for the safe and reliable operation of the controller. Ensure that each elevator controller disconnect is provided with a sufficient earth ground from the building, which must be connected to the earth ground terminal (PE) inside the elevator controller

**NOTE:** The ground wire size must match the AWG size of the internal ground lug wire inside the controller.

The system includes one or more common ground bus terminal blocks (PE).

The building, motor, transformer, and filter(s) must all share a common ground. Improper grounding can lead to various issues in modern elevator control systems. Proper grounding eliminates ground loops, reduces impedance, and diverts electrical noise safely to ground.

## 3 Review Voltage Settings

While Smartrise makes every effort to deliver equipment that is ready for installation out of the box, incomplete project information may require the use of default settings. These defaults are applied to protect the equipment from high voltage-related issues.

For instance, if the door operator for a specific job operates at 240 VAC but Smartrise was not informed during the engineering phase, the DR breaker (door operator voltage supply) will be set to 120 VAC by default as a safety precaution.

Before powering on the controller, verify that the voltage settings configured by Smartrise match the requirements of the installed equipment. Refer to the provided electrical drawings for confirmation.

## 4 Mount Controller

Mount and secure the controller in accordance with the applicable state and local codes for the job.

## 5 Set Up Main Power

This section describes how to safely connect the main power supply to the system before initiating construction activities.

**Procedure:**

1. Verify that the main disconnect switch is in the **OFF** position.
2. Ensure all green push breakers are in the **up** (OFF) position (i.e. M24, H24, R24, DR, 120, PS, etc.)
3. Verify that the L1/L2 breaker is in the **OFF** position.
  - Green = OFF
  - Red = ON
4. Connect main line power **L1/L2/L3** to the soft starter and motor.
5. Connect the ground wire to the **green terminal screw** on the soft starter mounting plate.
6. Ensure the Valve Board is connected to the Soft Starter (pre-wired from the factory) and connect the valves to the Valve Board.
7. Once the main power is safely connected, turn **ON** the L1/L2 breaker and all green push breakers.

## 6 Set Up Soft Starter & Valves

This section describes how to set up the soft starter and valves.

### Key I/O Connections to the Soft Starter:

- ◆ **Neutral:** Routed through the fault contactor, this signal allows torque control to the motor.
- ◆ **SM (Start Motor):** This signal comes from the Valve board and activates the soft starter, which then provides a voltage ramp-up to the motor.
- ◆ **SS Fault:** If a fault occurs in the soft starter, a fault signal is sent to the MR board.

Refer to **Hydro:Evolved Electrical Drawing, Starter and Valve Sheet** for detailed wiring information.

Refer to **Soft Starter Startup Manual Siemens Hydraulic Installation** and **Soft Starter Startup Manual Sprecher + Schuh Hydraulic Installation** for details.

### 6.1 Primary Soft Starter Configuration

The primary soft starter must be configured to ensure controlled motor startup and protection from voltage and current faults. The parameters include Ramp Up Time, Maximum Voltage (Vmax), Overcurrent, and Overtemperature.

#### 6.1.1 Ramp Up Time

Defines the time required for the soft starter to reach full voltage, minimizing torque and mechanical stress.

To set the Ramp Up Time:

1. Navigate to **Main Menu**.
2. Go to **Setup**.

3. Go to **Hydro**.
4. Go to **Soft Starter**.
5. Go to **Primary**.
6. Select **Ramp Up Time**.
7. Set the desired ramp up time.
8. Scroll right and press **Save**.

### 6.1.2 Vmax

Limits the maximum voltage applied to the motor, thereby controlling torque and current.

To set the Maximum Voltage (Vmax):

1. Navigate to **Main Menu**.
2. Go to **Setup**.
3. Go to **Hydro**.
4. Go to **Soft Starter**.
5. Go to **Primary**.
6. Select **Vmax**.
7. Enter the maximum voltage percentage.
8. Scroll right and press **Save**.

### 6.1.3 Over Current

Sets a current threshold to prevent motor overheating. Refer to the soft starter manufacturer's manual for appropriate values.

To set the Overcurrent Limit:

1. Navigate to **Main Menu**.
2. Go to **Setup**.
3. Go to **Hydro**.
4. Go to **Soft Starter**.
5. Go to **Primary**.

6. Select **Over Current**.
7. Enter the maximum allowable current.
8. Scroll right and press **Save**.

#### 6.1.4 Over Temperature

Defines the maximum allowable temperature before the system enters recovery mode and shuts down the motor.

To set the Overtemperature Limit:

1. Navigate to **Main Menu**.
2. Go to **Setup**.
3. Go to **Hydro**.
4. Go to **Soft Starter**.
5. Go to **Primary**.
6. Select **Over Temperature**.
7. Enter the maximum temperature.
8. Scroll right and press **Save**.

## 6.2 Secondary Soft Starter Configuration

If a secondary soft starter is installed, it must be configured to ensure proper operation with a dual-motor system.

### 6.2.1 Enable Secondary

Enables control of a second motor for high-capacity lifts.

To enable the Secondary Soft Starter:

1. Navigate to **Main Menu**.
2. Go to **Setup**.
3. Go to **Hydro**.
4. Go to **Soft Starter**.
5. Go to **Secondary**.
6. Select **Enable Secondary**.
7. Set to **ON**.

8. Scroll right and press **Save**.

### 6.2.2 Ramp Up Time

Defines the time required for the secondary soft starter to reach full voltage, minimizing torque and mechanical stress.

To set the Ramp Up Time:

1. Navigate to **Main Menu**.
2. Go to **Setup**.
3. Go to **Hydro**.
4. Go to **Soft Starter**.
5. Go to **Secondary**.
6. Select **Ramp Up Time**.
7. Set the desired ramp up time.
8. Scroll right and press **Save**.

### 6.2.3 Vmax

Limits the maximum voltage applied to the motor, thereby controlling torque and current.

To set the Maximum Voltage (Vmax):

1. Navigate to **Main Menu**.
2. Go to **Setup**.
3. Go to **Hydro**.
4. Go to **Soft Starter**.
5. Go to **Secondary**.
6. Select **Vmax**.
7. Enter the maximum voltage percentage.
8. Scroll right and press **Save**.

### 6.2.4 Over Current

Sets a current threshold to prevent motor overheating. Refer to the soft starter manufacturer's manual for appropriate values.

To set the Overcurrent Limit:

1. Navigate to **Main Menu**.
2. Go to **Setup**.
3. Go to **Hydro**.
4. Go to **Soft Starter**.
5. Go to **Secondary**.
6. Select **Over Current**.
7. Enter the maximum allowable current.
8. Scroll right and press **Save**.

### 6.2.5 Over Temperature

Defines the maximum allowable temperature before the system enters recovery mode and shuts down the motor.

To set the Overtemperature Limit:

1. Navigate to **Main Menu**.
2. Go to **Setup**.
3. Go to **Hydro**.
4. Go to **Soft Starter**.
5. Go to **Secondary**.
6. Select **Over Temperature**.
7. Enter the maximum temperature.
8. Scroll right and press **Save**.

## 6.3 Third Soft Starter Configuration

If a secondary soft starter is installed, it must be configured to ensure proper operation with a triple-motor system.

### 6.3.1 Enable Third

Activates the third soft starter when three motors are required to lift a car with a high-capacity load.

To enable the Third Soft Starter:

1. Navigate to **Main Menu**.

2. Go to **Setup**.
3. Go to **Hydro**.
4. Go to **Soft Starter**.
5. Go to **Third**.
6. Select **Enable Third**.
7. Set to **ON**.
8. Scroll right and press **Save**.

#### 6.4 Run with One Soft Starter Configuration

This setting allows the elevator to operate with a single soft starter if one of the others is faulted – provided the fault is not soft starter-specific. When enabled, faults are reported as alarms instead of shutdown events. This feature is only available if the secondary or third soft starter is enabled.

To allow operation with One Soft Starter:

1. Navigate to **Main Menu**.
2. Go to **Setup**.
3. Go to **Hydro**.
4. Go to **Soft Starter**.
5. Go to **Run With One Soft Starter**.
6. Set to **ON**.
7. Scroll right and press **Save**.

#### 6.5 Valves Configuration

This subsection covers the steps to configure the valves.

##### 6.5.1 Valve Type Select

The system supports different valve types.

To select the Valve type:

1. Navigate to **Main Menu**.
2. Go to **Setup**.
3. Go to **Hydro**.

4. Go to **Valve Type Select**.
5. Scroll and select the type of valve being used.
6. Scroll right and press **Save**.

### 6.5.2 Secondary Valve Board

A secondary valve is required when a dual-motor configuration is used for high-capacity elevators. Only the **SR Valve** type supports secondary valve control.

To enable the Secondary Valve board:

1. Navigate to **Main Menu**.
2. Go to **Setup**.
3. Go to **Hydro**.
4. Go to **Secondary Valve Board**.
5. Set to **ON**.
6. Scroll right and press **Save**.

### 6.5.3 Third Valve Board

In applications requiring three motors, a third valve board can be configured. As with the secondary, only the **SR Valve** type is supported.

To enable the Third Valve board:

1. Navigate to **Main Menu**.
2. Go to **Setup**.
3. Go to **Hydro**.
4. Go to **Third Valve Board**.
5. Set to **ON**.
6. Scroll right and press **Save**.

### 6.5.4 Fourth Valve Board

For systems utilizing four motors, a fourth valve board can be enabled. This option also supports only the **SR Valve** type.

To enable the Fourth Valve board:

1. Navigate to **Main Menu**.
2. Go to **Setup**.
3. Go to **Hydro**.
4. Go to **Fourth Valve Board**.
5. Set to **ON**.
6. Scroll right and press **Save**.

## 7 Set Up Construction Mode

Follow the wiring connections as shown in the **Hydro:Evolved Electrical Drawing, Car Tables Sheet** to operate the controller in Construction mode.

## 8 Set Up Wiring

Set up all wiring per the **Hydro:Evolved Electrical Drawing**.

## 9 Mount Car Top

Position and secure the Car Top assembly in accordance with the applicable state and local codes for the job.

## 10 Set Up Normal Mode

Set the controller to Normal mode by disconnecting the jumper between **MM** and **M24**, then switch the **Inspection/Normal** toggle to the **NORMAL** position.

**NOTE:** Before proceeding with the steps in the following sections or making any changes, ensure that **Adaptive Slowdown™** (U.S. Patent Pending) is turned **OFF**.

To disable Adaptive Slowdown™ (U.S. Patent Pending):

1. Navigate to **Main Menu**.
2. Go to **Setup**.
3. Go to **Hydro**.
4. Go to **Adaptive Slowdown™ System (U.S. Patent Pending)**.
5. Select **Enable Slowdown**.
6. Set to **OFF**.
7. Scroll right and press **Save**.

## 11 Set Up Speeds

This section outlines how to set the Contract, Inspection, Leveling, and Test Buffer speeds.

### 11.1 Contract Speed

Contract speed defines the car's maximum speed under no-load conditions. This value is used to calculate the slowdown distance across various speed thresholds.

- **Adjustment Range:** 10–200 FPM
- **Default:** Job Specific
- **Unit:** FPM

To set Contract Speed:

1. Navigate to **Main Menu**.
2. Go to **Setup**.
3. Go to **Speeds**.
4. Go to **Contract Speed**.
5. Set the Contract speed.
6. Scroll right and press **Save**.
7. Power Cycle.

### 11.2 Inspection Speed

Inspection speed is governed by valve settings.

- ◆ If inspection speed is **less than** contract speed, the car will move at **low speed**.
- ◆ If inspection speed **matches** contract speed, the car will operate at **high speed**.
- ◆ The controller will fault if speed feedback exceeds **150 FPM**.
  - **Adjustment Range:** 0–150 FPM
  - **Default:** 10 FPM
  - **Unit:** FPM

To verify or adjust Inspection Speed:

1. Navigate to **Main Menu**.
2. Go to **Setup**.
3. Go to **Speeds**.

4. Go to **Inspection Speed**.
5. In the **INSPECTION SPEED** menu, confirm the speed value is between 0 and 150 FPM. If set above 150 FPM, a fault will occur until the value is adjusted to 150 FPM or less.
6. Scroll right and press **Save**.

### 11.3 Leveling Speed

Leveling speed refers to the car's low-speed movement when only the leveling valve is active. This speed is influenced by valve regulation and the car's weight. Increased load may reduce leveling speed and prolong the leveling process if valves are not properly adjusted.

- **Adjustment Range:** 1–20 FPM
- **Default:** 10 FPM
- **Unit:** FPM

To Set Leveling Speed:

1. Navigate to **Main Menu**.
2. Go to **Setup**.
3. Go to **Speeds**.
4. Go to **Leveling Speed**.
5. Set the Leveling speed.
6. Scroll right and press **Save**.

### 11.4 Test Buffer Speed

The Test Buffer speed refers to the speed configured during buffer tests. If this speed is set equal to the contract speed, the car will move at high speed. If it is set to any other value, the car will operate at the Leveling speed.

- **Maximum Speed:** 200 FPM

To set Test Buffer Speed:

1. Navigate to **Main Menu**.
2. Go to **Setup**.
3. Go to **Speeds**.
4. Go to **Test Buffer Speed**.
5. Enter the desired buffer speed.
6. Scroll right and press **Save**.

## 12 Set Up Floors & Openings

The Number of Floors setting defines how many floors the car will recognize within the building. These settings are configured at the factory and should only be adjusted if they differ from the original order.

To set the Number of Floors:

1. Navigate to **Main Menu**.
2. Go to **Setup**.
3. Go to **Floors**.
4. Go to **Number of Floors**.
5. Set the correct number of floors.

**NOTE:** This total should include any **express zones** that are serviced by other cars in the group. The **opening map** will reflect only the floors served by the selected car.

6. Scroll right and press **Save**.

To set Floor Openings (Front or Rear):

If rear openings are required, first enable rear doors: **Main Menu** → **Setup** → **Door Setup** → **Rear Door** → **Set to ON**, then set DIP B2 to the ON position on the MR & CT.

1. Navigate to **Main Menu**.
2. Go to **Setup**.
3. Go to **Floors**.
4. Go to **Opening (Front or Rear)**.
5. Select the specific floors where the **front and/or rear doors** should open.
6. Scroll right and press **Save**.

## 13 Set Up Fire

Install the fire service jumpers as shown in the **Hydro:Evolved Electrical Drawing, Riser Board Connections Sheet**.

## 14 Set Up Hall Board

Configure the Hall Board DIP switch setting according to the **Hydro:Evolved Electrical Drawing, Hall Call Dip Switches Sheet**.

## 15 Set Up Floor Levels

This section outlines how to adjust the floor levels. Start with section **15.1 Primary Floor Level Adjustments**. If additional adjustments are required, continue with section **15.2 Fine-Tuning Floor Level Adjustments**.

### 15.1 Primary Floor Level Adjustments

Follow the steps below in exact order to adjust the floor levels.

#### 15.1.1 Maxton Valve Bypass Adjustment

The Valve Disable Bitmap parameter (32-0007) provides control over valve behavior by selectively disabling specific valves during defined phases of a run. While this parameter has a wide range of applications, its primary importance lies when having new Maxton valve requiring a bypass adjustment, which must be performed before any hoistway learning or leveling adjustments. Otherwise, it is not required to adjust the valve bypass.

The most critical application of this parameter is with a new Maxton requiring a valve bypass adjustment. The hoistway cannot be properly adjusted or learned until valves are set correctly. Valve adjustments made after the adaptive slowdown has already been learned will change leveling and stop times, requiring a restart of the process.

For bypass adjustment with a single Maxton valve, set the 2nd, 6th, and 8th bits to 1, resulting in a binary string of 1010 0010 (Hex value: X000000A2).

#### **Recommended First Step: Set Valve Board DIP Switch 3**

Before using the parameter-based method, attempt the bypass adjustment by setting **DIP switch 3 to ON** at the valve board. In most cases, this simpler method is sufficient.

If the DIP switch method does not produce the required result, use the parameter method shown below.

#### **Alternate Method: Adjust Parameter 32-0007**

Set the new Maxton valve bypass adjustment by following these steps:

1. Navigate to **Main Menu**.
2. Go to **Debug**.
3. Go to **Edit Parameter**.
4. Select **Hex Format**.
5. Set parameter **32-0007 = X000000A2**
6. Scroll right and press **Save**.

**Important:** After Maxton bypass adjustment, reset this parameter to all zeroes before making any further valve adjustments.

### 15.1.1.1 General Description of Valve Disable Bitmap

The Valve Disable Bitmap enables the selective disabling of specific valves on one or more valve boards during certain phases of a run.

**NOTE:** This parameter is available on software versions 65d0 to latest.

- ◆ **Scenario I:** This is useful in cases where, for example, the leveling valve should remain **OFF** during the high-speed phase of a run and only pick during the leveling phase.
- ◆ **Scenario II:** This is also helpful in cases where, for example, the additional valve boards are needed only during an upward travel, when the pump needs to lift heavy weights. During the downward direction, only the main (primary) valve board would be utilized.

**NOTE:** The scenarios are endless and very customer/job specific so to keep up with these constraints, the 32-bit parameter (32-0007) “ValvesDisableBitmap” is provided to give the user precise control on when and how each valve board (Primary, Secondary, etc.) behaves during a run.

This 32-bit parameter is divided into 4 sets, where each set controls the behavior of a specific valve board. Each set is made up of 8 bits. By toggling the bit, the mechanic can either enable or disable the valve's functionality during specific phases of operation. When a bit is switched from 0 to 1, this serves to disable a specific action of the valve during a particular phase. Referring to the figure below, the lowest set (right-most) corresponds to the 1<sup>st</sup> valve board, the next set represents the 2<sup>nd</sup> valve board, and the one after is for the 3<sup>rd</sup> valve board. The last set of 8 bits is for the 4<sup>th</sup> valve.

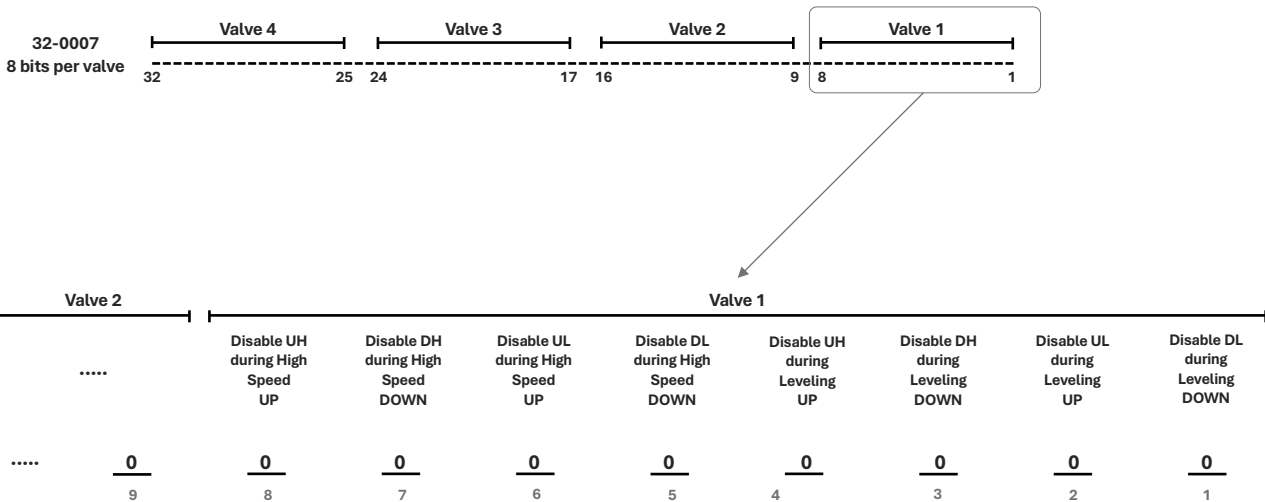

- Step 1:** Replace 0 with 1 to disable the required valve commands for valve 1
- Step 1a (only for jobs with more than one valve board):** Repeat the above step for valves 2, 3, and 4, if available
- Step 2:** Convert from Binary to DEC or HEX
- Step 3:** Save number in Parameter 32-0007

Each set is further split into two subsets of 4 bits – one subset for the high-speed phase and the other for the leveling phase. These subsets are then divided into the high-speed valve and the level Speed valve. Each Valve, whether for High UP, High DN, Level UP, or Level DN, is represented by 2 bits – one for the Up direction and the other for the Down direction.

- ◆ **Example I:** Consider the first bit in the control system. Changing the first bit from 0 to 1 at this position will prevent the primary valve board (valve 1) from picking the leveling valve during the leveling phase when a call is

placed in the down direction. This scenario is not logical, as it would cause the car to remain stationary during leveling phase. Setting the second bit to 1 will have the same effect.

- ◆ **Example II:** Changing the bit values at positions 6, 14, and 22 from 0 to 1, would mean Valve 1, Valve 2, and Valve 3 will not pick/activate the leveling valve when a car call is placed in the up direction during the high-speed phase. In this case, only the high-speed valves will be engaged during the high-speed phase of a run in the up direction, then switching to the leveling valves during the leveling phase. In the down direction, both high-speed and leveling valves will pick during the high-speed phase.

The table below presents some of the most common cases with their corresponding parameter value in both decimal and hexadecimal forms.

Case	Case Description	DEC	HEX
<b>One – Valve System</b>			
<b>Disable Leveling Valve during High Speed Down</b>	When the car is going down, only the high-speed valve will pick during the high-speed phase, then the leveling valve will pick during the leveling phase. When going up, both high-speed and leveling valves will pick during the high-speed state, then the leveling valve will pick during the leveling phase.	16	x10
<b>Disable Leveling Valve during High Speed Up</b>	When the car is going up, only the high-speed valve will pick during the high-speed phase, then the leveling valve will pick during the leveling phase. When going down, both high-speed and leveling valves will pick during the high-speed state, then the leveling valve will pick during the leveling phase.	32	x20
<b>Disable Leveling Valve during High Speed Down and High Speed Up</b>	When the car is going either up or down, only the high-speed valve will pick during the high-speed phases, then the leveling valve will pick during the leveling phases.	48	x30
<b>Two – Valve System</b>			
<b>Disable Leveling Valves during High Speed Down</b>	When the car is going down, only the high-speed valves will pick during the high-speed phase, then the leveling valves will pick during the leveling phase. When going up, both high-speed and leveling valves will pick during the high-speed state, then the leveling valves will pick during the leveling phase.	4112	x1010
<b>Disable Leveling Valves during High Speed Up</b>	When the car is going up, only the high-speed valves will pick during the high-speed phase, then the leveling valves will pick during the leveling phase. When going down, both high-speed and leveling valves will pick during the high-speed state, then the leveling valves will pick during the leveling phase.	8224	x2020
<b>Disable Leveling Valves during High Speed Down and High Speed Up</b>	When the car is going either up or down, only the high-speed valves will pick during the high-speed phases, then the leveling valves will pick during the leveling phases.	12336	x3030
<b>Disable Secondary Valve's High Speed Valve during High Speed Down</b>	When the car is going up, both the primary and secondary valve boards will pick/activate the high-speed valves during the high-speed phase. When going down, only the primary valve board will pick/activate) the high-speed valve during the high-speed phase. Both boards will pick the leveling valve during both up and down runs.	16384	x4000

### 15.1.2 Relevel Zone Size

The Relevel Zone Size (parameter 08-0158) sets the size of the releveling zone (also known as dead zone). When the elevator car is beyond this distance from the nearest learned floor position (also known as default floor position), the car will attempt to relevel.

**NOTE:** The dead zone is a software-defined area near the floor level where the elevator car stops, and within the dead zone, the car will not enter the releveling process. A zone size too small will cause a yo-yoing effect, a zone too large will hinder the releveling operation and allow the car to stay off level.

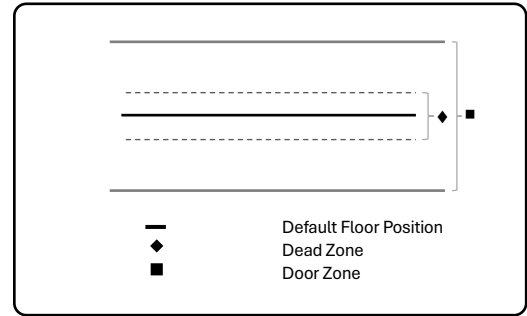

Set the Relevel Zone Size by following these steps:

1. Navigate to **Main Menu**.
2. Go to **Setup**.
3. Go to **Floors**.
4. Select **Relevel Zone Size**.
5. Set the Relevel Zone Size (default is 0.52 inches).
6. Scroll right and press **Save**.

### 15.1.3 Enable Releveling

The Enable Releveling function ensures that releveling is active whenever the car is within the door zone but outside the configured dead zone.

Enable Releveling by following these steps:

1. Navigate to **Main Menu**.
2. Go to **Setup**.
3. Go to **Floors**.
4. Select **Enable Releveling**.
5. Set to **ON**.
6. Scroll right and press **Save**.

### 15.1.4 Relevel Delay

The Relevel Delay is a timer that allows the car to stabilize before releveling is triggered, preventing unnecessary corrections if the car bounces.

Set the Relevel Delay by following these steps:

1. Navigate to **Main Menu**.
2. Go to **Setup**.
3. Go to **Floors**.
4. Select **Releveling Delay**.
5. Set the Relevel Delay (default is 0.5 seconds).
6. Scroll right and press **Save**.

### 15.1.5 Learn the Hoistway

This section explains how to learn the hoistway.

Before starting the hoistway learn process, ensure the following:

- The number of floors and openings is correctly configured.
- The process is performed at or below 25 FPM (feet per minute).
- The **Adaptive Slowdown™** (U.S. Patent Pending) is set to **OFF** (see section **10 Set Up Normal Mode**).
- All faults and alarms in Construction and Inspection Mode are resolved, and the DZ magnet is installed 2 inches above the bottom floor level, and 2 inches below the top floor level. This provides an extra safety buffer, reducing the risk of the car hitting the ring buffer (up direction) or car buffer (down direction).

#### Procedure:

Make sure Fire Service signals are active. If not, the elevator may enter Fire Service mode after the Hoistway Learn is complete.

1. Bring the car to either the **top** or **bottom** terminal landing on MR Inspection.
2. Confirm the **DZ input** to the CT board is high either by checking the **top right corner of the Main Screen** or by viewing the **Status** menu (see step 3).

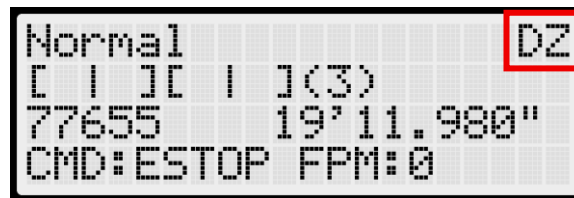

Figure 14: Check DZ Status from Main Screen

3. Navigate to **Main Menu | Status | Inputs**.
4. On the MR board, set the Inspection/Normal switch to the **NORMAL** position and **turn ON DIP switch 5A**.
5. The Main screen should change from **Normal** to **Hold UP/DN to Start**.

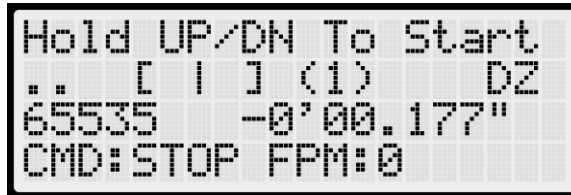

Figure 15: Normal to Hold UP/DN To Start

6. Depending on the car's position:
  - If the car is at the **top landing**, press and hold **Enable + Down** until the car starts moving.
  - If the car is at the **bottom landing**, press and hold **Enable + Up** until the car starts moving.
7. When the car stops, the screen will display **Learn Complete**.

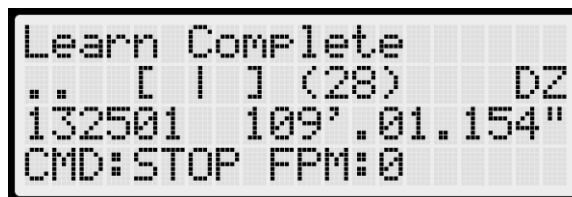

Figure 16: Learn Complete

8. On the MR board, **turn OFF DIP switch 5A**.

### 15.1.6 Generate Speeds and Thresholds

Follow these steps to generate the Speeds and Thresholds:

1. Navigate to **Main Menu**.
2. Go to **Setup**.
3. Go to **Hydro**.
4. Go to **Hydro Speed Setup**.
5. Select **Gen Thrshlds & Dist**.
6. Select **Yes**.
  - The screen will automatically return to **Hydro Speed Setup** – this is normal behavior.

### 15.1.7 Enable the Adaptive Slowdown System (U.S. Patent Pending)

Several peripherals affect the car's acceleration, deceleration, and speed in both the upward and downward directions. These include oil temperature and viscosity, and the car's weight.

The procedure below outlines how to enable the Adaptive Slowdown System (U.S. Patent Pending).

#### Enable Adaptive Slowdown System (U.S. Patent Pending):

1. Navigate to **Main Menu**.
2. Go to **Setup**.
3. Go to **Hydro**.
4. Go to **Adaptive Slowdown System (U.S. Patent Pending)**.
5. Select **Enable Slowdown**.
6. Set to **ON**.
7. Scroll right and press **Save**.
8. Run the car for 15 min, by enabling Debug Runs.

#### **Enable Debug Runs:**

1. On the MR board, turn **ON DIP switch 3A** (Disable doors).
2. Navigate to **Main Menu**.
3. Go to **Debug**.
4. Go to **DebugRuns**.
5. Select **Dwell Time**.
6. Set to **10s**.
7. Scroll right and press **Save**.
8. Next, navigate to **Random**.
9. Select the specific openings front and/or rear.
10. Set to **ON**.
11. Scroll right and press **Save**.
12. Allow controller to run on Random for 15 minutes.
13. After 15 minutes, Navigate to **Main Menu**.
14. Go to **Debug**.
15. Go to **DebugRuns**.
16. Select **Clear Debug Runs**.
17. Select **Yes**.

### 15.1.8 Floor Leveling Corrections

In some cases, even after applying Adaptive Slowdown, the car may still stop off level. When this occurs, additional floor level adjustments are required.

#### 15.1.8.1 Car is Too High/ Too Low

One method of correcting the floor level is by using the Too High/Too Low feature. If the car stops before floor level, increase the distance by the amount the car needs to move up. If the car stops above floor level, decrease the distance by the amount the car needs to move down.

**NOTE:** This adjustment should be made in only one direction – either up or down – where the offset is observed. As a result, the offset will be corrected in a single direction.

Follow these steps to adjust the floor level using the Too High/Too Low feature:

1. Navigate to **Main Menu | Setup | Floors**.
2. From the Floors menu, scroll and select **Too High/Too Low**.
3. If the car is stopping too low or too high:
  - i. If the car stops too low, go to step 4.
  - ii. If the car stops too high, go to step 5.
4. From the **Adjust Floors** menu, adjust the stopping point so the car stops at the exact floor level. For example, if the car stops 0.5” below the floor level, add that distance to the learned position. Go to step 6.
5. From the **Adjust Floors** menu, adjust the stopping point so the car stops at the exact floor level. For example, if the car stops 0.5” above the floor level, remove that distance to the learned position.
6. Scroll right and press **Save**.

The **Adjust Floors** menu displays the following:

- **Adjust Floors [ 1]:** The floor the car is currently at.
- **[ 1]+001.791”:** The distance the car needs to be adjusted to stop at floor level.
- **01 = +00000091:** The counts that determine the amount of distance needed for floor leveling.

#### 15.1.8.2 Store Floor Level

Another method for adjusting floor levels is to use the Store Floor Level feature. This function records and saves the current car position as the correct floor level reference.

Follow these steps to adjust the floor level using the Store Floor Level feature:

1. Place the car in Inspection mode.
2. Place the car exactly at the floor level.

3. Navigate to **Main Menu | Setup | Floors**.
4. From the **Floors** menu, scroll and select **Store Floor Level**.
5. From the **Store Floors** menu, scroll and select the floor’s position that is being changed.

**NOTE:** Only store the floor currently being adjusted. Storing the wrong floor will trigger a “Need to Learn” fault and require a full hoistway relearn.

6. Scroll right and press **Save**.

## 15.2 Fine-Tuning Floor Level Adjustments

If the floor levels are still not properly aligned after performing the steps in section **15.1 Primary Floor Level Adjustments**, perform the following corrective steps. These procedures are intended as a last measure to fine-tune floor leveling.

### 15.2.1 Destination Offset Up

Set the Destination Offset Up parameter (08-0169) when a command is signaled to the valves to stop the car during a normal run and the mechanic observes that the car stops beyond the default position while moving upward. Adjusting the parameter decreases the destination floor count by the set value when approaching a floor from below.

- ◆ **Scenario:** Consider a car during a normal run and traveling in the upward direction. When the car comes to a stop, its position might overshoot above the floor position. If this overshoot occurs frequently, the mechanic will have to activate the Destination Offset Up parameter by setting the value equal to the distance between the car position and the floor default position.

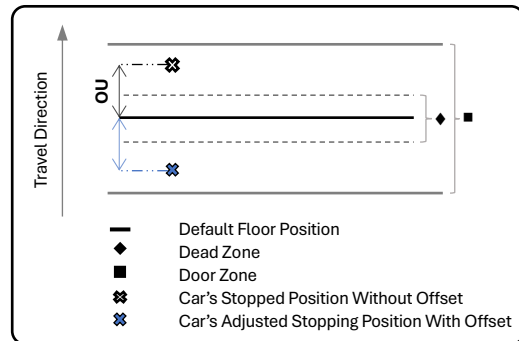

$$\text{Offset Up [OU]} = \text{Car Position After Stopping} - \text{Default Floor Position} \quad [\text{units in mm}]$$

- ◆ **Configuration:**

1. Navigate to **Main Menu**.
2. Go to **Setup**.
3. Go to **Hydro**.
4. Select **Dest. Offset Up**.
5. Enter the offset up value.
6. Scroll right and press **Save**.

**Important:** If the Destination Offset Up parameter has been adjusted, the Relevel Offset Up parameter should be adjusted as well. See section **15.2.3 Relevel Offset Up**.

### 15.2.2 Destination Offset Down

Set the Destination Offset Down parameter (08-0170) when a command is signaled to the valves to stop the car during a normal run and the mechanic observes that the car stops beyond the default position while moving downward. Adjusting the parameter increases the destination floor count by the set value when approaching a floor from above.

- ◆ **Scenario:** Consider a car during a normal run and traveling in the downward direction. When the car comes to a stop, its position might overshoot below the floor position. If this overshoot occurs frequently, the mechanic will have to activate the Destination Offset Down parameter by setting the value equal to the distance between the car position and the floor default position.

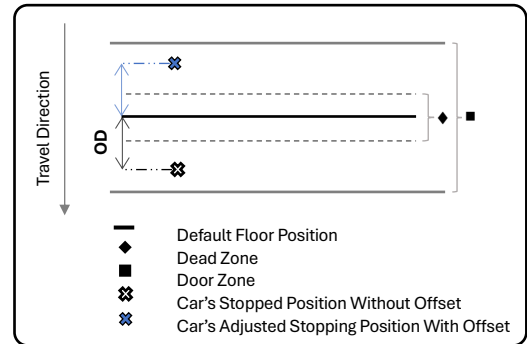

$$\text{Offset Down [OD]} = \text{Default Floor Position} - \text{Car Position After Stopping} \quad [\text{units in mm}]$$

◆ **Configuration:**

1. Navigate to **Main Menu**.
2. Go to **Setup**.
3. Go to **Hydro**.
4. Select **Dest. Offset Down**.
5. Enter the offset down value.
6. Scroll right and press **Save**.

**Important:** If the Destination Offset Down parameter has been adjusted, the Relevel Offset Down parameter should be adjusted as well. See section **15.2.4 Relevel Offset Down**.

### 15.2.3 Relevel Offset Up

Set Relevel Offset Up parameter (08-0156) when a command is signaled to the valves to stop the car during a relevel run and the mechanic observes that the car stops beyond the default position while moving upward. Adjusting the parameter decreases the releveling destination floor count by the set value when approaching a floor from below.

- ◆ **Scenario:** Consider a car traveling in the upward direction. When the car stops, it may relevel. After releveling, the car's position might overshoot above the floor position. If this overshoot occurs frequently, the mechanic will have to activate the Relevel Offset Up parameter by setting the value equal to the distance between the car position and the floor default position.

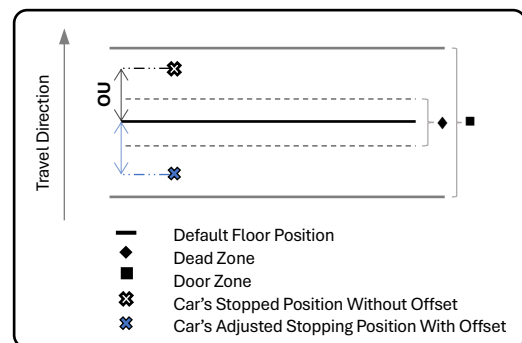

$$\text{Offset Up [OU]} = \text{Car Position After Stopping} - \text{Default Floor Position} \quad [\text{units in mm}]$$

◆ **Configuration:**

1. Navigate to **Main Menu**.
2. Go to **Setup**.
3. Go to **Hydro**.
4. Select **Relevel Offset Up**.
5. Enter the offset up value.
6. Scroll right and press **Save**.

### 15.2.4 Relevel Offset Down

Set the Relevel Offset Down parameter (08-0157) when a command is signaled to the valves to stop the car during a relevel run and the mechanic observes that the car stops beyond the default position while moving downward. Adjusting the parameter Increases the releveling destination floor count by the set value when approaching a floor from above.

- ◆ **Scenario:** Consider a car traveling in the downward direction. When the car stops, it may relevel. After releveling, the car's position might overshoot below the floor position. If this overshoot occurs frequently, the mechanic will have to activate the Relevel Offset Down parameter by setting the value equal to the distance between the car position and the floor default position.

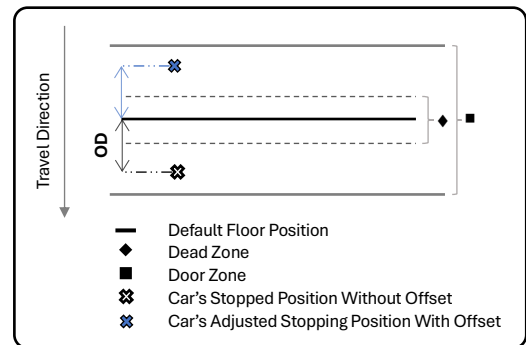

Offset Down [OD] = Default Floor Position - Car Position After Stopping

[units in mm]

◆ **Configuration:**

1. Navigate to **Main Menu**.
2. Go to **Setup**.
3. Go to **Hydro**.
4. Select **Relevel Offset Down**.
5. Enter the offset down value.
6. Scroll right and press **Save**.

### 15.2.5 Slowdown Offset Distance Up

The Slowdown Offset Distance Up parameter (08-0024) adds leveling distance to the existing slowdown distance used in the upward direction, extending the duration the car operates at leveling speed before reaching a floor. The units are measured in 0.2-inch increments.

◆ **Configuration:**

1. Navigate to **Main Menu**.
2. Go to **Debug**.
3. Go to **Edit Parameters**.
4. Select **Decimal Format**.
5. Set parameter **08-0024** [see equation above; default is 5 counts].
6. Scroll right and press **Save**.

$$\text{Slowdown Distance} = \text{Slowdown Offset Distance Up} + \text{Original Slowdown Distance Up} \quad [\text{units in mm}]$$

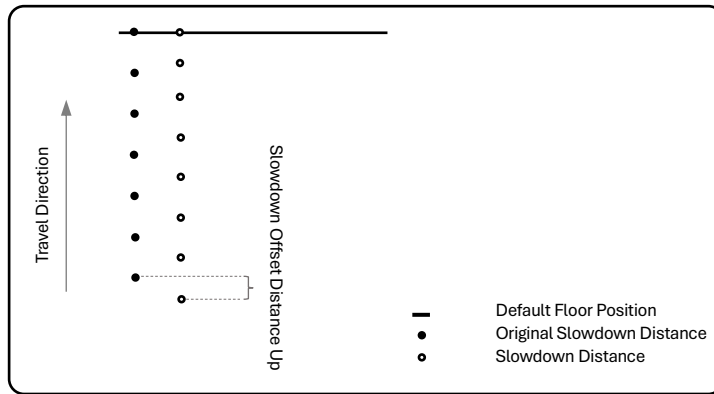

**15.2.6 Slowdown Offset Distance Down**

The Slowdown Offset Distance Down parameter (08-0038) adds leveling distance to the existing slowdown distance used in the downward direction, extending the duration the car operates at leveling speed before reaching a floor. The units are measured in 0.2-inch increments.

$$\text{Slowdown Distance} = \text{Slowdown Offset Distance Down} + \text{Original Slowdown Distance Down} \quad [\text{units in mm}]$$

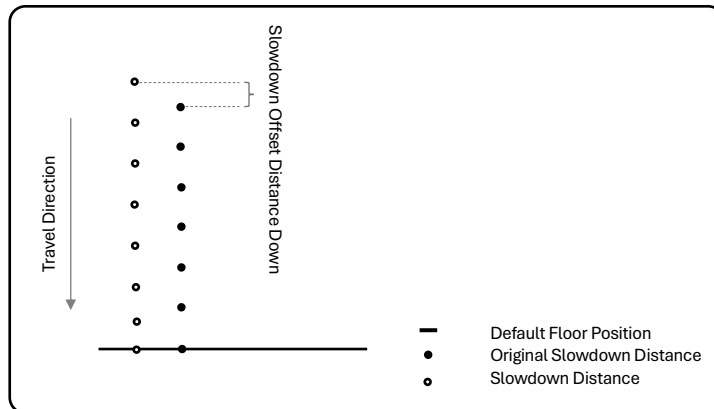

◆ **Configuration:**

1. Navigate to **Main Menu**.
2. Go to **Debug**.
3. Go to **Edit Parameters**.
4. Select **Decimal Format**.
5. Set parameter **08-0038** [see equation above; default is 5 counts].
6. Scroll right and press **Save**.

### 15.2.7 NTS Debounce

The NTS Debounce parameter (08-0139) defines the delay period after the car passes an NTS trip point before the NTS logic is activated. Units are in 25-ms counts.

◆ **Configuration:**

1. Navigate to **Main Menu**.
2. Go to **Debug**.
3. Go to **Edit Parameters**.
4. Select **Decimal Format**.
5. Set parameter **08-0139** [default is 10 counts].
6. Scroll right and press **Save**.

### 15.2.8 TSRD Debounce Limit

The TSRD Debounce Limit parameter (08-0118) sets the time the car must be in a TSRD overspeed state before a fault is flagged. Units are in 10-ms counts.

◆ **Configuration:**

1. Navigate to **Main Menu**.
2. Go to **Debug**.
3. Go to **Edit Parameters**.
4. Select **Decimal Format**.
5. Set parameter **08-0118** [default is 10 counts].
6. Scroll right and press **Save**.

The TSRD is the safety distance from the top and bottom floor levels within which the car must stop before hitting the ring in the up direction or the buffer in the down direction.

It is configured through: **Menu** → **Setup** → **Hydro** → **TSRD Distance** [default is 2 inches] → Adjust as needed → Scroll right and press **Save**.

If the car is traveling faster than **50 fpm** within the TSRD distance, and after the TSRD debounce limit, a fault is triggered and the car performs an emergency stop.

### 15.2.9 TSRD Offset From NTS

The TSRD Offset from NTS parameter (08-0128) adjusts the TSRD tripping point in reference to the NTS tripping point (the Slowdown point). If the car's speed exceeds speed threshold at either of these points after a debounce time limit, the car will trip a TSRD fault. The units are measured in 0.2-inch increments.

**NOTE:** This parameter can only be activated when the car is traveling in the upward direction.

#### ◆ Configuration:

1. Navigate to **Main Menu**.
2. Go to **Debug**.
3. Go to **Edit Parameters**.
4. Select **Decimal Format**.
5. Set parameter **08-0128** [default is 10 counts].
6. Scroll right and press **Save**.

*Page intentionally left blank.*

---

# **FAULTS & ALARMS**

---

# 1 Faults

The Faults menu displays all faults reported by the system's software and hardware.

## 1.1 Active Faults

When a fault is detected, its type and description appear under the Active Faults menu. Active faults may prevent the car from operating.

Follow these steps view the list of Active Faults:

1. Navigate to **Main Menu | Faults | Active**.
2. Review the list of faults currently preventing operation.
3. Scroll through the list and press the right button for a detailed description of each fault.

## 1.2 Logged Faults

All system faults are logged. The Logged Faults menu shows the fault history – up to 32 entries on the CT and COP boards, and up to 256 on the MR board.

Follow these steps to view the list of Logged Faults:

1. Navigate to **Main Menu | Faults | Logged**.
2. Review the list of previously recorded faults.

## 1.3 Cleared Faults

The Cleared Faults option deletes the entire fault history log.

Follow these steps to Clear the Logged Faults:

1. Navigate to **Main Menu | Faults | Clear Log**.
2. Press the right button and select Yes to confirm.

The table below lists the faults that may be reported by the software or hardware component.

Table 1: Faults Reported by Software or Hardware

Option	Description
<b>CPLD</b>	Depicts faults generated by hardware system.
<b>MRA</b>	Depicts faults generated on processor A of the MR board.
<b>MRB</b>	Depicts faults generated on processor B of the MR board.
<b>CTA</b>	Depicts faults generated on processor A of the CT board.
<b>CTB</b>	Depicts faults generated on processor B of the CT board.
<b>COPA</b>	Depicts faults generated on processor A of the COP board.
<b>COPB</b>	Depicts faults generated on processor B of the COP board.

## 1.4 List of Faults

The table below provides a list of possible system faults.

Table 2: List of Faults

Fault Number	Name	Description	Troubleshooting Procedure
1	Governor	Governor safety input is currently low.	Check wiring and safety contacts.
2	Governor (L)	Governor fault is latched.	Press the EBRK RST button to clear.
3	EB1 Drop	EB1 relay is currently dropped.	NA
4	EB1 Drop (L)	EB1 fault is latched.	Press the EBRK RST button to clear.
9	Speed Dev	Indicates a speed issue when a valve is active.	Check for a valve that is not opening.
10	IC Stop Sw	In car stop switch (COP-SF2) input is missing.	Check wiring and safety contacts.
11	Redun. LRB	Input read by the main MCU system and the CPLD safety system do not match.	Verify the board has its RDC jumper on.
12	Redun. LRM	Input read by the main MCU system and the CPLD safety system do not match.	Verify the board has its RDC jumper on.
13	Redun. LRT	Input read by the main MCU system and the CPLD safety system do not match.	Verify the board has its RDC jumper on.
14	Redun. LFB	Input read by the main MCU system and the CPLD safety system do not match.	Verify the board has its RDC jumper on.
15	Redun. LFM	Input read by the main MCU system and the CPLD safety system do not match.	Verify the board has its RDC jumper on.
16	Redun. LFT	Input read by the main MCU system and the CPLD safety system do not match.	Verify the board has its RDC jumper on.
17	Redun. ATU	Input read by the main MCU system and the CPLD safety system do not match.	Verify the board has its RDC jumper on.
18	Redun. ATD	Input read by the main MCU system and the CPLD safety system do not match.	Verify the board has its RDC jumper on.
19	Redun. ABU	Input read by the main MCU system and the CPLD safety system do not match.	Verify the board has its RDC jumper on.
20	Redun. ABD	Input read by the main MCU system and the CPLD safety system do not match.	Verify the board has its RDC jumper on.
21	Redun. Car Byp	Input read by the main MCU system and the CPLD safety system do not match.	Verify the board has its RDC jumper on.

Fault Number	Name	Description	Troubleshooting Procedure
22	Redun. HA Byp	Input read by the main MCU system and the CPLD safety system do not match.	Verify the board has its RDC jumper on.
23	Redun. MM	Input read by the main MCU system and the CPLD safety system do not match.	Verify the board has its RDC jumper on.
24	Redun. SFM	Input read by the main MCU system and the CPLD safety system do not match.	Verify the board has its RDC jumper on.
25	Redun. SFH	Input read by the main MCU system and the CPLD safety system do not match.	Verify the board has its RDC jumper on.
26	Redun. PIT	Input read by the main MCU system and the CPLD safety system do not match.	Verify the board has its RDC jumper on.
27	Redun. IP Insp	Input read by the main MCU system and the CPLD safety system do not match.	Verify the board has its RDC jumper on.
28	Redun. MR Insp	Input read by the main MCU system and the CPLD safety system do not match.	Verify the board has its RDC jumper on.
29	Redun. IL Insp	Input read by the main MCU system and the CPLD safety system do not match.	Verify the board has its RDC jumper on.
30	Redun. C EB2	Input read by the main MCU system and the CPLD safety system do not match.	Verify the board has its RDC jumper on.
31	Redun. C SFM	Input read by the main MCU system and the CPLD safety system do not match.	Verify the board has its RDC jumper on.
32	Redun. M EB2	Input read by the main MCU system and the CPLD safety system do not match.	Verify the board has its RDC jumper on.
33	Redun. M SFM	Input read by the main MCU system and the CPLD safety system do not match.	Verify the board has its RDC jumper on.
34	Redun. M EB3	Input read by the main MCU system and the CPLD safety system do not match.	Verify the board has its RDC jumper on.
35	Redun. M EB1	Input read by the main MCU system and the CPLD safety system do not match.	Verify the board has its RDC jumper on.
36	Redun. M SFP	Input read by the main MCU system and the CPLD safety system do not match.	Verify the board has its RDC jumper on.
37	Redun. C EB3	Input read by the main MCU system and the CPLD safety system do not match.	Verify the board has its RDC jumper on.

Fault Number	Name	Description	Troubleshooting Procedure
38	Redun. C EB1	Input read by the main MCU system and the CPLD safety system do not match.	Verify the board has its RDC jumper on.
39	Redun. C SFP	Input read by the main MCU system and the CPLD safety system do not match.	Verify the board has its RDC jumper on.
40	Redun. GSWR	Input read by the main MCU system and the CPLD safety system do not match.	Verify the board has its RDC jumper on.
41	Redun. GSWF	Input read by the main MCU system and the CPLD safety system do not match.	Verify the board has its RDC jumper on.
42	Redun. CT Insp	Input read by the main MCU system and the CPLD safety system do not match.	Verify the board has its RDC jumper on.
43	Redun. CT Stop Sw	Input read by the main MCU system and the CPLD safety system do not match.	Verify the board has its RDC jumper on.
44	Redun. Esc Hatch	Input read by the main MCU system and the CPLD safety system do not match.	Verify the board has its RDC jumper on.
45	Redun. Car Safety	Input read by the main MCU system and the CPLD safety system do not match.	Verify the board has its RDC jumper on.
46	Redun. Fire Stop Sw	Input read by the main MCU system and the CPLD safety system do not match.	Verify the board has its RDC jumper on.
47	Redun. IC Stop	Input read by the main MCU system and the CPLD safety system do not match.	Verify the board has its RDC jumper on.
48	Redun. IC Insp	Input read by the main MCU system and the CPLD safety system do not match.	Verify the board has its RDC jumper on.
49	Redun. HA Insp	Input read by the main MCU system and the CPLD safety system do not match.	Verify the board has its RDC jumper on.
50	SFP Stuck Lo	SFP relay is stuck in the OFF position.	Verify the relay is tightly seated on its connector.
51	SFP Stuck Hi	SFP relay is stuck in the ON position.	Verify the relay is tightly seated on its connector.
52	SFP Drop	SFP relay has been dropped.	Investigate the fault issued by the CPLD.
53	EB3 Stuck Lo	EB3 relay is stuck in the OFF position.	Verify the relay is tightly seated on its connector.
54	EB3 Stuck Hi	EB3 relay is stuck in the ON position.	Verify the relay is tightly seated on its connector.
55	EB4 Stuck Lo	EB4 relay is stuck in the OFF position.	Verify the relay is tightly seated on its connector.
56	EB4 Stuck Hi	EB4 relay is stuck in the ON position.	Verify the relay is tightly seated on its connector.

Fault Number	Name	Description	Troubleshooting Procedure
57	EB1 Stuck	EB1 relay is stuck.	Verify the relay is tightly seated on its connector.
62	HA Bypass Sw	Hall door bypass switch is ON.	Turn off machine room board H-DOOR switch.
63	Car Bypass Sw	Car door bypass switch is ON.	Turn off machine room board C-DOOR switch.
64	General OVSP	Car speed exceeded 110% of contract speed.	Confirm system speed and speed read from Cedes match.
65	General OVSP (L)	Car overspeed fault is latched.	Press EBRK RST button to clear.
66	Insp OVSP	Car speed exceeded 150 fpm in inspection mode.	Confirm system speed and speed read from Cedes match.
67	OVSP DO GSWF	Car speed exceeded 150 fpm with front gateswitch open.	Confirm system speed and speed read from Cedes match. Check door contacts and wiring.
68	OVSP DO LFT	Car speed exceeded 150 fpm with front top lock open.	Confirm system speed and speed read from Cedes match. Check door contacts and wiring.
69	OVSP DO LFM	Car speed exceeded 150 fpm with front middle lock open.	Confirm system speed and speed read from Cedes match. Check door contacts and wiring.
70	OVSP DO LFB	Car speed exceeded 150 fpm with front bottom lock open.	Confirm system speed and speed read from Cedes match. Check door contacts and wiring.
71	OVSP DO GSWR	Car speed exceeded 150 fpm with rear gateswitch open.	Confirm system speed and speed read from Cedes match. Check door contacts and wiring.
72	OVSP DO LRT	Car speed exceeded 150 fpm with rear top lock open.	Confirm system speed and speed read from Cedes match. Check door contacts and wiring.
73	OVSP DO LRM	Car speed exceeded 150 fpm with rear middle lock open.	Confirm system speed and speed read from Cedes match. Check door contacts and wiring.
74	OVSP DO LRB	Car speed exceeded 150 fpm with rear bottom lock open.	Confirm system speed and speed read from Cedes match. Check door contacts and wiring.
75	Flood OOS	Car is out of service on flood operation.	NA
76	Door Invalid	Necessary door inputs are not programmed, and the doors cannot function.	"Program the necessary door inputs.
77	MRA CPU Stop Sw	CPU stop switch is ON for the machine room board.	Turn off DIP A1 on the machine room board.
78	MRB CPU Stop Sw	CPU stop switch is ON for the machine room board.	Turn off DIP A1 on the machine room board.
79	CTA CPU Stop Sw	CPU stop switch is ON for the car top board.	Turn off DIP A1 on the car top board.
80	CTB CPU Stop Sw	CPU stop switch is ON for the car top board.	Turn off DIP A1 on the car top board.

Fault Number	Name	Description	Troubleshooting Procedure
81	COPA CPU Stop Sw	CPU stop switch is ON for the car operating panel board.	Turn off DIP A1 on the car operating panel board.
82	COPB CPU Stop Sw	CPU stop switch is ON for the car operating panel board.	Turn off DIP A1 on the car operating panel board.
83	Need To Cycle Pwr MR	A system configuration parameter was changed. The system must be power cycled.	Cycle power to the system.
84	Inv. Num Floors	Number of floors setting is outside the valid range.	Set number of floors to a value from 2 to 64.
85	Inv. Contract Spd	Contract speed setting is outside the valid range.	Set contract speed to a value from 10 to 1600.
86	Inv. Insp Spd	Inspection speed setting is outside the valid range.	Set inspection speed to a value from 0 to 150.
87	Inv. Learn Spd	Learn speed setting is outside the valid range.	Set learn speed to a value from 10 to contract speed.
88	Inv. Term Spd	Terminal speed setting is outside the valid range.	Set terminal speed to a value from 0 to 30.
89	Inv. Level Spd	Leveling speed setting is outside the valid range.	Set leveling speed to a value from 1 to 20.
90	Inv. NTSD Spd	NTS speed setting is outside the valid range.	Set NTS speed to a value from 1 to 20.
91	Need To Learn	Learned floor positions are invalid.	Set machine room DIP A5 and follow on screen instructions to learn floor positions.
96	At Floor No DZ	Car is at a learned floor level but is missing the door zone signal.	Adjust the learned floor position or door zone magnet at the fault position.
97	Fire Stop Switch	Fire stop switch (COP-SF3) input is missing.	Check wiring and safety contacts.
98	Door F Jumper GSW	Gate switch jumper was detected. Gate switch input must go low to clear.	Remove jumper or increase the door jumper timeout setting.
99	Door F Jumper Lock	Lock jumper was detected. A lock input must go low to clear.	Remove jumper or increase the door jumper timeout setting.
100	Door F Locks Open	A lock was stuck open when closing doors.	NA
101	Door F GSW Open	Gate switch stuck open when closing doors.	NA
102	Door F Fail Open	Door failed to open.	NA
103	Door F Fail Close	Door failed to close.	NA
106	Door F Lost Signal	Door signals were unexpectedly lost.	NA
107	Door R Jumper GSW	Gate switch jumper was detected. Gate switch input must go low to clear.	Remove jumper or increase the door jumper timeout setting.

Fault Number	Name	Description	Troubleshooting Procedure
108	Door R Jumper Lock	Lock jumper was detected. A lock input must go low to clear.	Remove jumper or increase the door jumper timeout setting.
109	Door R Locks Open	A lock was stuck open when closing doors.	NA
110	Door R GSW Open	Gate switch stuck open when closing doors.	NA
111	Door R Fail Open	Door failed to open.	NA
112	Door R Fail Close	Door failed to close.	NA
115	Door R Lost Signal	Door signals were unexpectedly lost.	NA
116	Max Runtime	Car made a single run that exceeded the run time limit.	Adjust max runtime setting.
117	EB Byp	EB3 or EB4 bypass relay is stuck in the ON position.	NA
118	MRA Param OVF	Machine room processor A parameter edit buffer overflowed.	Reduce rate of parameter edit requests.
119	MRB Param OVF	Machine room processor B parameter edit buffer overflowed.	Reduce rate of parameter edit requests.
120	CTA Param OVF	Car top processor A parameter edit buffer overflowed.	Reduce rate of parameter edit requests.
121	CTB Param OVF	Car top processor B parameter edit buffer overflowed.	Reduce rate of parameter edit requests.
122	COPA Param OVF	Car operating panel processor A parameter edit buffer overflowed.	Reduce rate of parameter edit requests.
123	COPB Param OVF	Car operating panel processor B parameter edit buffer overflowed.	Reduce rate of parameter edit requests.
124	MRA Offline (CTA)	MR-A processor reported offline by CT-A processor.	Check wiring of communication lines. Check for stalled HB LEDs.
125	MRA Offline (COPA)	MR-A processor reported offline by COP-A processor.	Check wiring of communication lines. Check for stalled HB LEDs.
126	MRA Offline (MRB)	MR-A processor reported offline by MR-B processor.	Check wiring of communication lines. Check for stalled HB LEDs.
127	CTA Offline (MRA)	CT-A processor reported offline by MR-A processor.	Check wiring of communication lines. Check for stalled HB LEDs.
128	CTA Offline (COPA)	CT-A processor reported offline by COP-A processor.	Check wiring of communication lines. Check for stalled HB LEDs.
129	CTA Offline (CTB)	CT-A processor reported offline by CT-B processor.	Check wiring of communication lines. Check for stalled HB LEDs.
130	COPA Offline (MRA)	COP-A processor reported offline by MR-A processor.	Check wiring of communication lines. Check for stalled HB LEDs.
131	COPA Offline (CTA)	COP-A processor reported offline by CT-A processor.	Check wiring of communication lines. Check for stalled HB LEDs.

Fault Number	Name	Description	Troubleshooting Procedure
132	COPA Offline (COPB)	COP-A processor reported offline by COP-B processor.	Check wiring of communication lines. Check for stalled HB LEDs.
133	MRB Offline (MRA)	MR-B processor reported offline by MR-A processor.	Check wiring of communication lines. Check for stalled HB LEDs.
134	CTB Offline (CTA)	CT-B processor reported offline by CT-A processor.	Check wiring of communication lines. Check for stalled HB LEDs.
135	COPB Offline (COPA)	COP-B processor reported offline by COP-A processor.	Check wiring of communication lines. Check for stalled HB LEDs.
136	MRA Board Rst	Processor was reset, triggered by power loss or user reset.	NA
137	MRB Board Rst	Processor was reset, triggered by power loss or user reset.	NA
138	CTA Board Rst	Processor was reset, triggered by power loss or user reset.	NA
139	CTB Board Rst	Processor was reset, triggered by power loss or user reset.	NA
140	COPA Board Rst	Processor was reset, triggered by power loss or user reset.	NA
141	COPB Board Rst	Processor was reset, triggered by power loss or user reset.	NA
142	MRA WDT Rst	Processor was reset, triggered by watch dog.	NA
143	MRB WDT Rst	Processor was reset, triggered by watch dog.	NA
144	CTA WDT Rst	Processor was reset, triggered by watch dog.	NA
145	CTB WDT Rst	Processor was reset, triggered by watch dog.	NA
146	COPA WDT Rst	Processor was reset, triggered by watch dog.	NA
147	COPB WDT Rst	Processor was reset, triggered by watch dog.	NA
148	MRA BOD Rst	Processor was reset, triggered by dip in board voltage.	NA
149	MRB BOD Rst	Processor was reset, triggered by dip in board voltage.	NA
150	CTA BOD Rst	Processor was reset, triggered by dip in board voltage.	NA

Fault Number	Name	Description	Troubleshooting Procedure
151	CTB BOD Rst	Processor was reset, triggered by dip in board voltage.	NA
152	COPA BOD Rst	Processor was reset, triggered by dip in board voltage.	NA
153	COPB BOD Rst	Processor was reset, triggered by dip in board voltage.	NA
154	SS SFH	Hoistway safety (MR-SFH) input missing.	Check wiring and safety contacts.
155	SS SFM	Machine room safety (MR-SFM) input missing.	Check wiring and safety contacts.
156	SS PIT	Pit (MR-PIT) input missing.	Check wiring and safety contacts.
157	SS BUF	Buffer (MR-BUF) input missing.	Check wiring and safety contacts.
158	SS TFL	Top final limit (MR-TFL) input missing.	Check wiring and safety contacts.
159	SS BFL	Bottom final limit (MR-BFL) input missing.	Check wiring and safety contacts.
160	SS CT Stop Sw	Car top switch (CT-SF1) input missing.	Check wiring and safety contacts.
161	SS Esc Hatch	Car top escape hatch (CT-SF2) input missing.	Check wiring and safety contacts.
162	SS Car Safeties	Car top car safeties (CT-SF3) input missing.	Check wiring and safety contacts.
163	LFT Open	Front top lock is open.	Check wiring and safety contacts.
164	LFM Open	Front middle lock is open.	Check wiring and safety contacts.
165	LFB Open	Front bottom lock is open.	Check wiring and safety contacts.
166	LRT Open	Rear top lock is open.	Check wiring and safety contacts.
167	LRM Open	Rear middle lock is open.	Check wiring and safety contacts.
168	LRB Open	Rear bottom lock is open.	Check wiring and safety contacts.
169	GSWF Open	Front gate switch is open.	Check wiring and safety contacts.
170	GSWR Open	Rear gate switch is open.	Check wiring and safety contacts.
174	120VAC Loss	Machine room 120 VAC supply is missing.	Check wiring and safety contacts.
176	Mo. Prepare Run	Motion start sequence aborted due to unsafe door state.	Check door contacts.
182	Mo. Accel Delay	Requested run distance is too short (less than 0.25 inch).	Verify the car is not rolling back at the start of run.
188	Mo. Preflight	Motion stop sequence aborted after failing to complete preflight.	NA
192	EB2 Stuck	EB2 relay is stuck.	Verify the relay is tightly seated on its connector.

Fault Number	Name	Description	Troubleshooting Procedure
215	CPLD Startup	CPLD reporting a startup state.	NA
217	CPLD Governor	CPLD reporting a governor fault.	Press the EBRK RST button to clear.
218	CPLD Redundancy	CPLD reporting a redundancy fault.	NA
219	CPLD Comm Loss	CPLD reporting loss of CN2 network communication.	Check for miswiring on the CN2 network. Check CT/COP toggle switch.
220	CPLD Non Bypass	CPLD reporting loss of a no bypass input.	Check machine room and car top safety inputs.
221	CPLD In Car	CPLD reporting loss of in car stop input.	Check COP SF2 input.
222	CPLD Insp.	CPLD reporting invalid inspection mode.	An invalid set of inspection switches are active.
223	CPLD SFH	CPLD reporting loss of SFH input.	Check machine room SFH input.
225	CPLD Access	CPLD reporting invalid access switch and lock combination.	NA
226	CPLD Locks	CPLD reporting lock open.	NA
227	CPLD Doors	CPLD reporting gate switch open.	NA
228	CPLD Bypass Sw	CPLD reporting a bypass switch is active.	NA
229	CPLD Preflight	CPLD reporting preflight failure.	NA
234	DZ Stuck Hi	Door zone stuck high and over six inches from the closest learned floor position.	Check DZ input wiring (CT-503/504). Check for obstruction of the DZ sensor.
235	Position Limit	Car moving outside the mode defined position limit.	Option to bypass term limits is available.
236	Inv. Manual Run	Attempting a manual run outside specified the current position limits.	Option to bypass term limits is available.
245	SFM Stuck	SFM relay is stuck.	Verify the relay is tightly seated on its connector.
247	MR Preflight	Preflight test failed.	NA
248	CT Preflight	Preflight test failed.	NA
249	COP Preflight	Preflight test failed.	NA
250	MRB Param Sync	Parameters are synchronizing.	NA
251	CTA Param Sync	Parameters are synchronizing.	NA
252	CTB Param Sync	Parameters are synchronizing.	NA
258	Inv. DIP B2	Rear door DIP switch and parameter do not match.	Match DIP and parameter setting.

<b>Fault Number</b>	<b>Name</b>	<b>Description</b>	<b>Troubleshooting Procedure</b>
<b>259</b>	Inv. DIP B3	Enable landing inspection DIP switch and parameter do not match.	Match DIP and parameter setting.
<b>260</b>	Inv. DIP B4	Enable pit inspection DIP switch and parameter do not match.	Match DIP and parameter setting.
<b>262</b>	Inv. DIP A6	Construction mode is required when the motor learn DIP switch is ON.	Move to construction mode or clear DIP A6.
<b>263</b>	CT Insp Reqs IC Insp	Both IC and CT inspection switches are required for CT inspection operation.	Assert both IC and CT inspection switches. Optionally turn off this parameter enabled option.
<b>269</b>	EXP 1-8 Comm	Communication loss between system and master or master and slave expansions	Check expansion 1-8 CAN bus wiring
<b>270</b>	EXP 9-16 Comm	Communication loss between system and master or master and slave expansions	Check expansion 9-16 CAN bus wiring
<b>271</b>	EXP 17-24 Comm	Communication loss between system and master or master and slave expansions	Check expansion 17-24 CAN bus wiring
<b>272</b>	EXP 25-32 Comm	Communication loss between system and master or master and slave expansions	Check expansion 25-32 CAN bus wiring
<b>273</b>	EXP 33-40 Comm	Communication loss between system and master or master and slave expansions	Check expansion 33-40 CAN bus wiring
<b>274</b>	EXP 41-48 Comm	Communication loss between system and master or master and slave expansions	Check expansion 41-48 CAN bus wiring
<b>275</b>	EXP 49-56 Comm	Communication loss between system and master or master and slave expansions	Check expansion 49-56 CAN bus wiring
<b>276</b>	EXP 57-64 Comm	Communication loss between system and master or master and slave expansions	Check expansion 57-64 CAN bus wiring
<b>277</b>	EXP 65-72 Comm	Communication loss between system and master or master and slave expansions	Check expansion 65-72 CAN bus wiring

<b>Fault Number</b>	<b>Name</b>	<b>Description</b>	<b>Troubleshooting Procedure</b>
278	EXP 73-80 Comm	Communication loss between system and master or master and slave expansions	Check expansion 73-80 CAN bus wiring
279	EXP 81-88 Comm	Communication loss between system and master or master and slave expansions	Check expansion 81-88 CAN bus wiring
280	EXP 89-96 Comm	Communication loss between system and master or master and slave expansions	Check expansion 89-96 CAN bus wiring
281	EXP 97-104 Comm	Communication loss between system and master or master and slave expansions	Check expansion 97-104 CAN bus wiring
282	EXP 105-112 Comm	Communication loss between system and master or master and slave expansions	Check expansion 105-112 CAN bus wiring
283	EXP 113-120 Comm	Communication loss between system and master or master and slave expansions	Check expansion 113-120 CAN bus wiring
284	EXP DIP 1	Two or more expansion boards have the same master DIP switch 1 settings.	Check if two or more master expansions have master 1 dip settings
285	EXP DIP 2	Two or more expansion boards have the same master DIP switch 2 settings.	Check if two or more master expansions have master 2 dip settings
286	EXP DIP 3	Two or more expansion boards have the same master DIP switch 3 settings.	Check if two or more master expansions have master 3 dip settings
287	EXP DIP 4	Two or more expansion boards have the same master DIP switch 4 settings.	Check if two or more master expansions have master 4 dip settings
288	EXP DIP 5	Two or more expansion boards have the same master DIP switch 5 settings.	Check if two or more master expansions have master 5 dip settings
289	EXP DIP 6	Two or more expansion boards have the same master DIP switch 6 settings.	Check if two or more master expansions have master 6 dip settings
290	EXP DIP 7	Two or more expansion boards have the same master DIP switch 7 settings.	Check if two or more master expansions have master 7 dip settings
291	EXP DIP 8	Two or more expansion boards have the same master DIP switch 8 settings.	Check if two or more master expansions have master 8 dip settings

Fault Number	Name	Description	Troubleshooting Procedure
292	EXP DIP 9	Two or more expansion boards have the same master DIP switch 9 settings.	Check if two or more master expansions have master 9 dip settings
293	EXP DIP 10	Two or more expansion boards have the same master DIP switch 10 settings.	Check if two or more master expansions have master 10 dip settings
294	EXP DIP 11	Two or more expansion boards have the same master DIP switch 11 settings.	Check if two or more master expansions have master 11 dip settings
295	EXP DIP 12	Two or more expansion boards have the same master DIP switch 12 settings.	Check if two or more master expansions have master 12 dip settings
296	EXP DIP 13	Two or more expansion boards have the same master DIP switch 13 settings.	Check if two or more master expansions have master 13 dip settings
297	EXP DIP 14	Two or more expansion boards have the same master DIP switch 14 settings.	Check if two or more master expansions have master 14 dip settings
298	EXP DIP 15	Two or more expansion boards have the same master DIP switch 15 settings.	Check if two or more master expansions have master 15 dip settings
299	Inv. Hall Mask	There is overlap between the hall call, medical, and swing masks.	NA
300	OOS Fault	Car has been taken out of service. Triggering source is undefined.	Clear OOS by moving to inspection mode.
301	Inv. Group ID	Two or more group cars have the same car ID.	NA
306	CEDES1 Offline	Communication with CEDES channel 1 was lost.	Check camera wiring.
307	CEDES1 Read	CEDES channel 1 reporting a failure to read error.	Clean the tape. Align the tape with the camera.
308	CEDES1 Close	CEDES channel 1 reporting the tape is aligned too close relative to the camera.	Clean the tape. Align the tape with the camera.
309	CEDES1 Far	CEDES channel 1 reporting the tape is aligned too far relative to the camera.	Clean the tape. Align the tape with the camera.
310	CEDES1 Left	CEDES channel 1 reporting the tape is aligned too left relative to the camera.	Clean the tape. Align the tape with the camera.

Fault Number	Name	Description	Troubleshooting Procedure
311	CEDES1 Right	CEDES channel 1 reporting the tape is aligned too right relative to the camera.	Clean the tape. Align the tape with the camera.
312	CEDES1 Internal	CEDES channel 1 reporting an internal error.	NA
313	CEDES1 Comm.	CEDES channel 1 reporting a communication error.	NA
314	CEDES1 X1 Pos	CEDES channel 1 reporting a position cross check error.	NA
315	CEDES1 X1 Vel	CEDES channel 1 reporting a velocity cross check error.	NA
316	CEDES1 X1 Both	CEDES channel 1 reporting a cross check error.	NA
317	CEDES1 X2 Pos	CEDES channel 1 reporting a position cross check error.	NA
318	CEDES1 X2 Vel	CEDES channel 1 reporting a velocity cross check error.	NA
319	CEDES1 X2 Both	CEDES channel 1 reporting a cross check error.	NA
320	CEDES2 Offline	Communication with CEDES channel 2 was lost.	Check camera wiring.
321	CEDES2 Read	CEDES channel 2 reporting a failure to read error.	Clean the tape. Align the tape with the camera.
322	CEDES2 Close	CEDES channel 2 reporting the tape is aligned too close relative to the camera.	Clean the tape. Align the tape with the camera.
323	CEDES2 Far	CEDES channel 2 reporting the tape is aligned too far relative to the camera.	Clean the tape. Align the tape with the camera.
324	CEDES2 Left	CEDES channel 2 reporting the tape is aligned too left relative to the camera.	Clean the tape. Align the tape with the camera.
325	CEDES2 Right	CEDES channel 2 reporting the tape is aligned too right relative to the camera.	Clean the tape. Align the tape with the camera.
326	CEDES2 Internal	CEDES channel 2 reporting an internal error.	NA
327	CEDES2 Comm.	CEDES channel 2 reporting a communication error.	NA
328	CEDES2 X1 Pos	CEDES channel 2 reporting a position cross check error.	NA
329	CEDES2 X1 Vel	CEDES channel 2 reporting a velocity cross check error.	NA
330	CEDES2 X1 Both	CEDES channel 2 reporting a cross check error.	NA
331	CEDES2 X2 Pos	CEDES channel 2 reporting a position cross check error.	NA
332	CEDES2 X2 Vel	CEDES channel 2 reporting a velocity cross check error.	NA

Fault Number	Name	Description	Troubleshooting Procedure
333	CEDES2 X2 Both	CEDES channel 2 reporting a cross check error.	NA
334	E-Power OOS	Car is on emergency power and not configured to return to automatic operation.	NA
335	Inv. Parking	Parking floor is set to a landing with no openings.	NA
336	Inv. Fire Main	Main fire recall floor and opening are invalid.	NA
337	Inv. Fire Alt	Alternate fire recall floor and opening are invalid.	NA
338	MR CPLD Offline	Communication with machine room CPLD lost.	NA
339	CT CPLD Offline	Communication with car top CPLD lost.	NA
340	COP CPLD Offline	Communication with car operating panel CPLD lost.	NA
341	DG Expired	Car network datagram expired.	NA
654	Inv. Land Off	Group landing offset setting it outside valid range.	The sum of the landing offset and the car's number of floors should be less than the max supported landings.
655	Payment Passcode	Enter payment passcode under SETUP   MISC   PAYMENT PASSCODE.	Submit payment and receive payment passcode from Smartrise Engineering.
656	Battery Check Fail	Battery lowering device is reporting a fault state. Battery Test Time is set under SETUP   Hydro   Battery Test Time. The BLD reported 3 or more battery faults within 3 days.	Check backup battery If fault occurred from BLD reporting 3 or more faults within 3 days check backup battery and toggle DIP A1.
713	FAULT INPUT	Discrete fault input has been high for 200ms.	Check IO configuration & wiring.
716	Max Runs Per Minute	Car exceeding max number of runs per minute.	Check that car is not repeatedly releveling for a floor.
717	Need To Cycle Pwr CT	A system configuration parameter was changed. The system must be power cycled.	Cycle power to the system.
718	Need To Cycle Pwr COP	A system configuration parameter was changed. The system must be power cycled.	Cycle power to the system.
719	Front TCL Open	Front top closed interlock is open	Check wiring of TCL, GSW and DZ signals. This fault is flagged when outside of DZ and TCL is open. It is also flagged when GSW is closed and TCL is open.

Fault Number	Name	Description	Troubleshooting Procedure
720	Front MCL Open	Front middle closed interlock is open	Check wiring of MCL, GSW and DZ signals. This fault is flagged when outside of DZ and MCL is open. It is also flagged when GSW is closed and MCL is open.
721	Front BCL Open	Front bottom closed interlock is open	Check wiring of BCL, GSW and DZ signals. This fault is flagged when outside of DZ and BCL is open. It is also flagged when GSW is closed and BCL is open.
722	Rear TCL Open	Rear top closed interlock is open	Check wiring of TCL, GSW and DZ signals. This fault is flagged when outside of DZ and TCL is open. It is also flagged when GSW is closed and TCL is open.
723	Rear MCL Open	Rear middle closed interlock is open	Check wiring of MCL, GSW and DZ signals. This fault is flagged when outside of DZ and MCL is open. It is also flagged when GSW is closed and MCL is open.
724	Rear BCL Open	Rear bottom closed interlock is open	Check wiring of BCL, GSW and DZ signals. This fault is flagged when outside of DZ and BCL is open. It is also flagged when GSW is closed and BCL is open.
725	Inv. EPWR Spd	Emergency power speed setting is outside the valid range.	Set epower speed to a value from 10 to the configured contract speed.
726	Inv. ACCESS Spd	Access speed setting is outside the valid range.	Set access speed to a value from 0 to 150.
727	Unint. LCK And GSW	A GSW and Lock is open and the car is more than two and a half inches from the nearest learned floor position. The movement direction agrees with the commanded.	Check wiring and safety contacts.
728	DPMF Open	Front DPM Open	Check wiring and safety contacts.
729	DPMR Open	Rear DPM Open	Check wiring and safety contacts.
730	CPLD MR Startup	CPLD reporting a startup state.	NA
731	CPLD CT Startup	CPLD reporting a startup state.	NA
732	CPLD COP Startup	CPLD reporting a startup state.	NA
734	CPLD CT Comm	MR CPLD reporting loss of communication with CT CPLD.	Check for miswiring on the CN2 network. Check CT/COP toggle switch.
735	CPLD COP Comm	CT CPLD reporting loss of communication with COP CPLD.	Check for miswiring on the CN2 network. Check CT/COP toggle switch.
736	CPLD 120 VAC	CPLD reporting loss of 120 AC supply.	NA

<b>Fault Number</b>	<b>Name</b>	<b>Description</b>	<b>Troubleshooting Procedure</b>
737	CPLD Gov	CPLD reporting loss of machine room governor input.	Press the EBRK RST button to clear.
738	CPLD Car Byp	CPLD reporting invalid activation of machine room car door bypass switch.	NA
739	CPLD Hall Byp	CPLD reporting invalid activation of machine room hall door bypass switch.	NA
740	CPLD SFM	CPLD reporting loss of machine room SFM input.	NA
741	CPLD SFH	CPLD reporting loss of machine room SFH input.	NA
742	CPLD PIT	CPLD reporting loss of machine room PIT input.	NA
743	CPLD BUF	CPLD reporting loss of machine room BUF input.	NA
744	CPLD TFL	CPLD reporting loss of machine room TFL input.	NA
745	CPLD BFL	CPLD reporting loss of machine room BFL input.	NA
746	CPLD CT SW	CPLD reporting loss of car top switch (CT-SF1) input.	NA
747	CPLD Esc Hatch	CPLD reporting loss of escape hatch (CT-SF2) input.	NA
748	CPLD Car Safety	CPLD reporting loss of car safeties (CT-SF3) input.	NA
749	CPLD IC Stop	CPLD reporting loss of in car stop switch (COP-SF2) input.	NA
750	CPLD Fire Stop	CPLD reporting loss of fire stop switch (COP-SF3) input.	NA
751	CPLD Insp.	CPLD reporting invalid inspection mode.	NA
752	CPLD Access	CPLD reporting invalid hoistway access move request.	NA
753	CPLD LFT	CPLD reporting multiple locks are open or a lock is open outside of door zone.	NA
754	CPLD LFM	CPLD reporting multiple locks are open or a lock is open outside of door zone.	NA
755	CPLD LFB	CPLD reporting multiple locks are open or a lock is open outside of door zone.	NA
756	CPLD LRT	CPLD reporting multiple locks are open or a lock is open outside of door zone.	NA

Fault Number	Name	Description	Troubleshooting Procedure
757	CPLD LRM	CPLD reporting multiple locks are open or a lock is open outside of door zone.	NA
758	CPLD LRB	CPLD reporting multiple locks are open or a lock is open outside of door zone.	NA
759	CPLD GSWF	CPLD reporting gate switch is open outside of door zone.	NA
760	CPLD GSWR	CPLD reporting gate switch is open outside of door zone.	NA
761	PF Pit Insp	CPLD reporting preflight check failed.	NA
762	PF Lnd Insp	CPLD reporting preflight check failed.	NA
763	PF BFL	CPLD reporting preflight check failed.	NA
764	PF TFL	CPLD reporting preflight check failed.	NA
765	PF BUF	CPLD reporting preflight check failed.	NA
766	PF PIT	CPLD reporting preflight check failed.	NA
767	PF GOV	CPLD reporting preflight check failed.	NA
768	PF SFH	CPLD reporting preflight check failed.	NA
769	PF SFM	CPLD reporting preflight check failed.	NA
770	PF LFT	CPLD reporting preflight check failed.	NA
771	PF LFM	CPLD reporting preflight check failed.	NA
772	PF LFB	CPLD reporting preflight check failed.	NA
773	PF LRT	CPLD reporting preflight check failed.	NA
774	PF LRM	CPLD reporting preflight check failed.	NA
775	PF LRB	CPLD reporting preflight check failed.	NA
776	PF Hall Byp	CPLD reporting preflight check failed.	NA
777	PF Car Byp	CPLD reporting preflight check failed.	NA
778	PF MR Insp	CPLD reporting preflight check failed.	NA
779	PF C Pick Byp	CPLD reporting preflight check failed.	NA

Fault Number	Name	Description	Troubleshooting Procedure
780	PF M Pick Byp	CPLD reporting preflight check failed.	NA
781	PF M Drop Grip	CPLD reporting preflight check failed.	NA
782	PF C Drop Grip	CPLD reporting preflight check failed.	NA
783	PF C Pick Grip	CPLD reporting preflight check failed.	NA
784	PF M Pick Grip	CPLD reporting preflight check failed.	NA
785	PF M Drop Byp	CPLD reporting preflight check failed.	NA
786	PF C Drop Byp	CPLD reporting preflight check failed.	NA
787	CPLD MR Unk.	CPLD reporting out of range error.	NA
788	PF CT Sw	CPLD reporting preflight check failed.	NA
789	PF Esc Hatch	CPLD reporting preflight check failed.	NA
790	PF Car Safety	CPLD reporting preflight check failed.	NA
791	PF CT Insp	CPLD reporting preflight check failed.	NA
792	PF GSWF	CPLD reporting preflight check failed.	NA
793	PF GSWR	CPLD reporting preflight check failed.	NA
794	PF DZF	CPLD reporting preflight check failed.	NA
795	PF DZR	CPLD reporting preflight check failed.	NA
796	CPLD CT Unk	CPLD reporting out of range error.	NA
797	PF HA Insp	CPLD reporting preflight check failed.	NA
798	PF IC Stop	CPLD reporting preflight check failed.	NA
799	PF FSS	CPLD reporting preflight check failed.	NA
800	PF IC Insp	CPLD reporting preflight check failed.	NA
801	CPLD COP Unk	CPLD reporting out of range error.	NA
805	OVSP DO DPMF	Car speed exceeded 150 fpm with front door position monitor open.	Confirm system speed and speed read from Cedes match. Check door contacts and wiring.

Fault Number	Name	Description	Troubleshooting Procedure
806	OVSP DO DPMR	Car speed exceeded 150 fpm with rear door position monitor open.	Confirm system speed and speed read from Cedes match. Check door contacts and wiring.
807	EQ	Seismic input is high	Check the Seismic input
808	PHE Test Fail	Freight door photoeye test has failed.	Check light curtain hardware.
809	Mo. Prepare GSWF Open	Motion start sequence aborted due to incorrect GSWF state.	Check the GSWF contact.
810	Mo. Prepare LFT Open	Motion start sequence aborted due to incorrect LFT state.	Check the LFT contact.
811	Mo. Prepare LFM Open	Motion start sequence aborted due to incorrect LFM state.	Check the LFM contact.
812	Mo. Prepare DPM F Open	Motion start sequence aborted due to incorrect DPM F state.	Check the DPM F contact
813	Mo. Prepare LFB Open	Motion start sequence aborted due to incorrect LFB state.	Check the LFB contact.
814	Mo. Prepare GSWR Open	Motion start sequence aborted due to incorrect GSWR state.	Check the GSWR contact.
815	Mo. Prepare LRT Open	Motion start sequence aborted due to incorrect LRT state.	Check the LRT contact.
816	Mo. Prepare LRM Open	Motion start sequence aborted due to incorrect LRM state.	Check the LRM contact.
817	Mo. Prepare LRB Open	Motion start sequence aborted due to incorrect LRB state.	Check the LRB contact.
818	Mo. Prepare DPM R Open	Motion start sequence aborted due to incorrect DPM R state.	Check the DPM R contact.
819	Mo. Accel GSWF Open	Motion start sequence aborted due to missing GSWF.	Check the GSWF contact.
820	Mo. Accel LFT Open	Motion start sequence aborted due to missing LFT .	Check the LFT contact.
821	Mo. Accel LFM Open	Motion start sequence aborted due to missing LFM.	Check the LFM contact.
822	Mo. Accel LFB Open	Motion start sequence aborted due to missing LFB.	Check the LFB contact.
823	Mo. Accel DPM F Open	Motion start sequence aborted due to missing DPM F.	Check the DPM F contact.

Fault Number	Name	Description	Troubleshooting Procedure
824	Mo. Accel GSWR Open	Motion start sequence aborted due to missing GSWR.	Check the GSWR contact.
825	Mo. Accel LRT Open	Motion start sequence aborted due to missing LRT.	Check the LRT contact.
826	Mo. Accel LRM Open	Motion start sequence aborted due to missing LRM.	Check the LRM contact.
827	Mo. Accel LRB Open	Motion start sequence aborted due to missing LRB.	Check the LRB contact.
828	Mo. Accel DPM R Open	Motion start sequence aborted due to missing DPM R.	Check the DPM R contact.
829	Mo. Prepare DCL F	Motion start sequence aborted due to incorrect DCL F state.	Check the DCL F contact.
830	Mo. Prepare DCL R	Motion start sequence aborted due to incorrect DCL R state.	Check the DCL R contact.
831	Mo. Prepare DOL F	Motion start sequence aborted due to incorrect DOL F state.	Check the DOL F contact.
832	Mo. Prepare DOL R	Motion start sequence aborted due to incorrect DOL R state.	Check the DOL R contact.
833	Mo. Accel DCL F	Motion start sequence aborted due to missing DCL F.	Check the DCL F contact.
834	Mo. Accel DCL R	Motion start sequence aborted due to missing DCL R.	Check the DCL R contact.
835	Mo. Accel DOL F	Motion start sequence aborted due to incorrect DOL F state.	Check the DOL F contact.
836	Mo. Accel DOL R	Motion start sequence aborted due to incorrect DOL R state.	Check the DOL R contact.
837	Valve Unk	Primary primary valve board reporting an unknown fault.	Check primary valve board and wiring.
838	Valve POR Rst	Primary primary valve board recovering from a reset due to power off.	Check primary valve board and wiring.
839	Valve WDT Rst	Primary primary valve board recovering from reset due to watchdog.	Check primary valve board and wiring.
840	Valve BOD Rst	Primary primary valve board recovering from reset due to voltage dip.	Check primary valve board and wiring.
841	Valve Comm Loss	Primary primary valve board reporting loss of	Check primary valve board and wiring.

Fault Number	Name	Description	Troubleshooting Procedure
		communication with elevator controller.	
842	Valve Level Dn	Primary primary valve board reporting mismatch between valve control and status signals of level speed down output.	Replace primary valve board
843	Valve Level Up	Primary primary valve board reporting mismatch between valve control and status signals of level speed up output.	Replace primary valve board
844	Valve High Dn	Primary primary valve board reporting mismatch between valve control and status signals of high speed down output.	Replace primary valve board
845	Valve High Up	Primary primary valve board reporting mismatch between valve control and status signals of high speed up output.	Replace primary valve board
846	Valve SM	Primary primary valve board reporting mismatch between control and status signals of the start motor output.	Replace primary valve board
847	Valve Inv. Cmd.	Primary primary valve board reporting both up and down commands issued at the same time.	Check primary valve board and wiring.
848	Valve CAN Bus Rst	Primary primary valve board reporting a CAN bus reset.	Check primary valve board and wiring.
849	SS Unk	Primary soft starter reporting an unknown fault.	Check primary soft starter board and wiring.
850	SS POR Rst	Primary soft starter recovering from a reset due to power off.	Check primary soft starter board and wiring.
851	SS WDT Rst	Primary soft starter recovering from reset due to watchdog.	Check primary soft starter board and wiring.
852	SS BOD Rst	Primary soft starter recovering from reset due to voltage dip.	Check primary soft starter board and wiring.
853	SS Comm Loss	Primary soft starter reporting loss of communication with the elevator controller.	Check primary soft starter board and wiring.
854	SS OC	Primary soft starter reporting an overcurrent error.	Check primary soft starter board and wiring.

Fault Number	Name	Description	Troubleshooting Procedure
855	SS OVV	Primary soft starter reporting an overvoltage error.	Check primary soft starter board and wiring.
856	SS UNDV	Primary soft starter reporting an undervoltage error.	Check primary soft starter board and wiring.
857	SS Phase Miss	Primary soft starter reporting a missing phase.	Check primary soft starter board and wiring.
858	SS Phase Seq	Primary soft starter reporting phase sequence error.	Check primary soft starter board and wiring.
859	SS CAN Bus Rst	Primary soft starter reporting a CAN bus reset.	Check primary soft starter board and wiring.
860	Valve Offline	Communication lost with primary valve board.	Check primary valve board and wiring.
861	SS Offline	Communication lost with primary soft starter.	Check primary soft starter board and wiring.
862	Motor Overheat	The Motor Overheat input has been triggered. The motor is overheated.	Check the Motor Overheat input. Check the state of the motor.
863	Valve2 Unk	Secondary valve board reporting an unknown fault.	Check secondary valve board and wiring.
864	Valve2 POR Rst	Secondary valve board recovering from a reset due to power off.	Check secondary valve board and wiring.
865	Valve2 WDT Rst	Secondary valve board recovering from reset due to watchdog.	Check secondary valve board and wiring.
866	Valve2 BOD Rst	Secondary valve board recovering from reset due to voltage dip.	Check secondary valve board and wiring.
867	Valve2 Comm Loss	Secondary valve board reporting loss of communication with elevator controller.	Check secondary valve board and wiring.
868	Valve2 Level Dn	Secondary valve board reporting mismatch between valve control and status signals of level speed down output.	Replace secondary valve board
869	Valve2 Level Up	Secondary valve board reporting mismatch between valve control and status signals of level speed up output.	Replace secondary valve board
870	Valve2 High Dn	Secondary valve board reporting mismatch between valve control and status signals of high speed down output.	Replace secondary valve board
871	Valve2 High Up	Secondary valve board reporting mismatch between	Replace secondary valve board

Fault Number	Name	Description	Troubleshooting Procedure
		valve control and status signals of high speed up output.	
872	Valve2 SM	Secondary valve board reporting mismatch between control and status signals of the start motor output.	Replace secondary valve board
873	Valve2 Inv. Cmd.	Secondary valve board reporting both up and down commands issued at the same time.	Check secondary valve board and wiring.
874	Valve2 CAN Bus Rst	Secondary valve board reporting a CAN bus reset.	Check secondary valve board and wiring.
875	Valve2 Offline	Communication lost with secondary valve board.	Check secondary valve board and wiring.
876	Valve Dupl. Addr.	Two primary valve boards detected on the network.	Check valve board addressing.
877	Valve2 Dupl. Addr.	Two secondary valve boards detected on the network.	Check valve board addressing.
878	TSRD OVSP	Car speed exceeded the top terminal speed limit.	Increase the TSRD position offset, increase the TSRD debounce limit, or adjust the learned slowdown points.
880	Low Oil	Low Oil input is active suggesting oil levels are low.	Check oil levels, Low Oil Input, then reset the latching fault via the reset button.
881	Learn Slowdowns	Learned slowdown distances are invalid.	Check learned slowdown distances. To learn slowdown distances, turn ON machine room DIP A5, and turn ON Learn_Slowdowns (01-253) parameter. Then position the car at the bottom landing and follow on screen instructions to learn slowdowns in the up direction. Then position the car at the top landing and follow on screen instructions to learn slowdowns in the down direction.
882	Low Pressure	Low Pressure input is active suggesting there is low pressure.	Check Pump Low Pressure Sensor, Check Low Pressure input.
883	Low Oil MLT	Car pump motor stayed consistently ON during one run and exceeded the run time limit.	Check pump Oil levels
884	SS2 Offline	Communication lost with secondary soft starter.	Check secondary soft starter board and wiring.
885	SS2 Unk	Secondary soft starter reporting an unknown fault.	Check secondary soft starter board and wiring.
886	SS2 POR Rst	Secondary soft starter recovering from a reset due to power off.	Check secondary soft starter board and wiring.

Fault Number	Name	Description	Troubleshooting Procedure
887	SS2 WDT Rst	Secondary soft starter recovering from reset due to watchdog.	Check secondary soft starter board and wiring.
888	SS2 BOD Rst	Secondary soft starter recovering from reset due to voltage dip.	Check secondary soft starter board and wiring.
889	SS2 Comm Loss	Secondary soft starter reporting loss of communication with the elevator controller.	Check secondary soft starter board and wiring.
890	SS2 OC	Secondary soft starter reporting an overcurrent error.	Check secondary soft starter board and wiring.
891	SS2 OVV	Secondary soft starter reporting an overvoltage error.	Check secondary soft starter board and wiring.
892	SS2 UNDV	Secondary soft starter reporting an undervoltage error.	Check secondary soft starter board and wiring.
893	SS2 Phase Miss	Secondary soft starter reporting a missing phase.	Check secondary soft starter board and wiring.
894	SS2 Phase Seq	Secondary soft starter reporting phase sequence error.	Check secondary soft starter board and wiring.
895	SS2 CAN Bus Rst	Secondary soft starter reporting a CAN bus reset.	Check secondary soft starter board and wiring.
896	Viscosity Max Cycles	Viscosity Operation reached its maximum number of cycles	Check Viscosity sensor and input, then reset the latching fault via Dip A1.
897	SS Input Flt	Discrete input fault 1 from the Soft Starter has been activated	Check the SS Input fault and the contact feeding the input from the drive.
898	SS2 Input Flt	Discrete input fault 2 from the Soft Starter has been activated.	Check the SS 2 Input fault, and the contact feeding the input from the drive.
899	Phase Flt	Line monitoring hardware has detected voltage lines are out of phase or missing. Only checked if programmed.	Check line monitoring hardware and wiring.
900	COPA Param Sync	Parameters are synchronizing.	NA
901	COPB Param Sync	Parameters are synchronizing.	NA
902	SS ADDR	Primary soft starter reporting another board on the network has the same address.	Check primary soft starter address DIP switches.
903	SS2 ADDR	Secondary soft starter reporting another board on	Check secondary soft starter address DIP switches.

Fault Number	Name	Description	Troubleshooting Procedure
		the network has the same address.	
904	UPH Valve MON	Monitoring of safety relay for cutting the up high valve's neutral side showing an invalid state. Valid only for bucher and blain valve type configurations.	Check the wiring of the UPH VALVE MON input.
905	DNH Valve MON	Monitoring of safety relay for cutting the down high valve's neutral side showing an invalid state. Valid only for bucher and blain valve type configurations.	Check the wiring of the DNH VALVE MON input.
906	INSP Valve MON	Monitoring of safety relay for cutting the inspection valve's neutral side showing an invalid state. Valid only for bucher and blain valve type configurations.	Check the wiring of the INSP VALVE MON input.
908	OOS Consecutive	Car has flagged the same fault 3 times in a row and has been taken out of service.	This fault does not auto clear. Controller must be power cycled to clear this state.
909	OOS Hourly	The car has flagged more than X faults within an hour and the car has been taken out of service. This hour is not aligned with the real time clock. This OOS state will auto reset after the hour passes. X is HourlyFaultLimit (08-160).	Investigate the faults logged within an hour of this fault. Reset the controller or move to inspection to clear the fault immediately, otherwise this fault auto clears after an hour.
910	OOS Door	The car has flagged more than X door faults within an hour and the car has been taken out of service. This hour is not aligned with the real time clock. This OOS state will auto reset after the hour passes. X is DoorHourlyFaultLimit (08-148).	Investigate the door faults logged within an hour of this fault. Reset the controller or move to inspection to clear the fault immediately, otherwise this fault auto clears after an hour.
911	OOS Max Starts	The car has attempted to run more than X times within a minute. This minute is not aligned with the real time clock. This OOS state will auto reset after the minute passes. X is	Check if the car is repeatedly correcting or releveling trying to make floor level. Check if the car is repeatedly trying and failing to start a run. Reset the controller or move to inspection to clear the fault immediately. Otherwise, the fault auto clears after 1 minute.

Fault Number	Name	Description	Troubleshooting Procedure
		MaxStartsPerMinute (08-196).	
912	OOS Key switch	The car has been taken out of service by the OOS key switch input.	Check the status of the OOS key switch input.
913	OOS DL20	The car has been taken out of service by the DL20 fixture.	Check the fault status of the DL20 fixture.
914	Delta Stuck Active	The Delta relay's feedback signal shows the relay is active, when the Delta output driving the relay is inactive. Valid for hydro controllers with wye delta style starters.	Check the status of the delta relay.
915	Delta Stuck Inactive	The Delta relay's feedback signal shows the relay is inactive, when the Delta output driving the relay is active. Valid for hydro controllers with wye delta style starters.	Check the status of the delta relay.
916	Starter Overload	Starter overload relay used for contactor-based starters is active.	Check the status of the starter overload relay.
917	EB1 Drop H	EB1 relay which is controlled by the redundant safety processor (and should normally follow the EB2 relay) is currently dropped when it should be picked.	Check the status of the EB1 and EB2 relays.
918	Can't Run Up	If Low Oil, MLT, or Motor Overheat is active in the background, the controller is prevented from running up in all modes of operation.	Verify that Low Oil, MLT, or Motor Overheat is not active. Clear Low Oil and MLT faults via Dip A1 reset.
919	Inv. Run Dist.	The car has moved since its original destination assessment. The new destination request is no longer achievable.	Depending on the amount of movement that occurs when the run drops, and the car's configured SETUP   SCURVE   DEST. OFFSET UP, DEST. OFFSET DOWN, RELEVEL OFFSET UP, RELEVEL OFFSET DOWN, the car may not be able to make the requested run. Reducing the amount of car movement at the end of run will reduce the likelihood of this occurring.
1000	COUNTER WEIGHT DERAIL	The controller CW Derail was triggered.	Verify is the CW derail was activated.
1001	CEDES1 CRC FAILURE	CEDES channel 1 Data CRC check error.	NA

Fault Number	Name	Description	Troubleshooting Procedure
1002	CEDES2 CRC FAILURE	CEDES channel 2 Data CRC check error.	NA
1003	Valve L-Dn OvrlD	Primary valve board reporting Over Current on level speed down output.	Check primary valve board wiring and valve solenoid.
1004	Valve L-Up OvrlD	Primary valve board reporting Over Current on level speed up output.	Check primary valve board wiring and valve solenoid.
1005	Valve H-Dn OvrlD	Primary valve board reporting Over Current on high speed down output.	Check primary valve board wiring and valve solenoid.
1006	Valve H-Up OvrlD	Primary valve board reporting Over Current on high speed up output.	Check primary valve board wiring and valve solenoid.
1007	Valve L-Dn Shrt	Primary valve board reporting a Short on level speed down output.	Check primary valve board wiring and valve solenoid.
1008	Valve L-Up Shrt	Primary valve board reporting a Short on level speed up output.	Check primary valve board wiring and valve solenoid.
1009	Valve H-Dn Shrt	Primary valve board reporting a Short on high speed down output.	Check primary valve board wiring and valve solenoid.
1010	Valve H-Up Shrt	Primary valve board reporting a Short on high speed up output.	Check primary valve board wiring and valve solenoid.
1011	S-Motor Out-Shrt	Motor Start on Primary valve board is reporting a Short	Check motor start wiring between primary valve board and soft starter
1012	Valve L-Dn Open	Primary valve board reporting Open Circuit on the output.	Check primary valve board and wiring.
1013	Valve L-Up Open	Primary valve board reporting Open Circuit on the output.	Check primary valve board and wiring.
1014	Valve H-Dn Open	Primary valve board reporting Open Circuit on the output.	Check primary valve board and wiring.
1015	Valve H-Up Open	Primary valve board reporting Open Circuit on the output.	Check primary valve board and wiring.
1016	H-Speed En Fault	Primary valve board High Speed Enable Output Failure	Primary Valve Board Open or Shorted TRIAC Output
1017	Valve2 L-Dn OvrlD	Secondary valve board reporting Over Current on level speed down output.	Check secondary valve board wiring and valve solenoid.
1018	Valve2 L-Up OvrlD	Secondary valve board reporting Over Current on level speed up output.	Check secondary valve board wiring and valve solenoid.
1019	Valve2 H-Dn OvrlD	Secondary valve board reporting Over Current on high speed down output.	Check secondary valve board wiring and valve solenoid.

<b>Fault Number</b>	<b>Name</b>	<b>Description</b>	<b>Troubleshooting Procedure</b>
<b>1020</b>	Valve2 H-Up Ovrd	Secondary valve board reporting Over Current on high speed up output.	Check secondary valve board wiring and valve solenoid.
<b>1021</b>	Valve2 L-Dn Shrt	Secondary valve board reporting a Short on level speed down output.	Check secondary valve board wiring and valve solenoid.
<b>1022</b>	Valve2 L-Up Shrt	Secondary valve board reporting a Short on level speed up output.	Check secondary valve board wiring and valve solenoid.
<b>1023</b>	Valve2 H-Dn Shrt	Secondary valve board reporting a Short on high speed down output.	Check secondary valve board wiring and valve solenoid.
<b>1024</b>	Valve2 H-Up Shrt	Secondary valve board reporting a Short on high speed up output.	Check secondary valve board wiring and valve solenoid.
<b>1025</b>	S-Motor2 Out-Shrt	Motor Start on Secondary valve board is reporting a Short	Check motor start wiring between secondary valve board and soft starter
<b>1026</b>	Valve2 L-Dn Open	Secondary valve board reporting Open Circuit on the output.	Check secondary valve board and wiring.
<b>1027</b>	Valve2 L-Up Open	Secondary valve board reporting Open Circuit on the output.	Check secondary valve board and wiring.
<b>1028</b>	Valve2 H-Dn Open	Secondary valve board reporting Open Circuit on the output.	Check secondary valve board and wiring.
<b>1029</b>	Valve2 H-Up Open	Secondary valve board reporting Open Circuit on the output.	Check secondary valve board and wiring.
<b>1030</b>	H-Speed2 En Fault	Secondary valve board High Speed Enable Output Failure	Secondary Valve Board Open or Shorted TRIAC Output
<b>1031</b>	SS3 Input Ftt	Discrete input fault 3 from the Soft Starter has been activated.	Check the SS 3 Input fault, and the contact feeding the input from the soft starter.
<b>1032</b>	Valve3 Unk	Third valve board reporting an unknown fault.	Check third valve board and wiring.
<b>1033</b>	Valve3 POR Rst	Third valve board recovering from a reset due to power off.	Check third valve board and wiring.
<b>1034</b>	Valve3 WDT Rst	Third valve board recovering from reset due to watchdog.	Check third valve board and wiring.
<b>1035</b>	Valve3 BOD Rst	Third valve board recovering from reset due to voltage dip.	Check third valve board and wiring.
<b>1036</b>	Valve3 Comm Loss	Third valve board reporting loss of communication with elevator controller.	Check third valve board and wiring.
<b>1037</b>	Valve3 Level Dn	Third valve board reporting mismatch between valve	Check third valve board and wiring.

Fault Number	Name	Description	Troubleshooting Procedure
		control and status signals of level speed down output.	
1038	Valve3 Level Up	Third valve board reporting mismatch between valve control and status signals of level speed up output.	Check third valve board and wiring.
1039	Valve3 High Dn	Third valve board reporting mismatch between valve control and status signals of high speed down output.	Check third valve board and wiring.
1040	Valve3 High Up	Third valve board reporting mismatch between valve control and status signals of high speed up output.	Check third valve board and wiring.
1041	Valve3 SM	Third valve board reporting mismatch between control and status signals of the start motor output.	Check third valve board and wiring.
1042	Valve3 Inv. Cmd.	Third valve board reporting both up and down commands issued at the same time.	Check third valve board and wiring.
1043	Valve3 CAN Bus Rst	Third valve board reporting a CAN bus reset.	Check third valve board and wiring.
1044	Valve3 Offline	Communication lost with third valve board.	Check third valve board and wiring.
1045	Valve3 Dupl. Addr.	Two third valve boards detected on the network.	Check third valve board addressing.
1046	Bypass UM Redundancy	The MCUB_X8 sent from MRB to CPLD is not consistent with the feedback value from CPLD	
1047	Dir. Counter Tripped	The direction change counter exceeded the maximum allowed value.	Program the direction change counter reset input and activate it.
1048	Glass Window Switch	Glass window switch input has been activated.	Check glass window switch wiring.
1049	Rupture Switch	Rupture switch input has been activated.	Check rupture switch wiring.
1050	Pressure Switch	Pressure switch input has been activated.	Check pressure switch wiring.
1051	Collapsible CT Rail	This fault is asserted if parameter 01-339 is on and one of the following conditions is met : * The car is collapsible fully stowed(input on) and the mode of operation is on CT . * The car is collapsible fully	Check inputs collapsible fully stowed and collapsible fully extended

Fault Number	Name	Description	Troubleshooting Procedure
		extended (input on) while the car is not on CT operation. * The car is not fully collapsible extended and not collapsible fully stowed.	
1052	SS TFL2	Second Top final limit (MR-TFL2) input missing.	Check wiring and safety contacts.
1053	CPLD TFL2	CPLD reporting loss of machine room TFL2 input.	NA
1054	Valve3 L-Dn OvrlD	Third valve board reporting Over Current on level speed down output.	Check third valve board wiring and valve solenoid.
1055	Valve3 L-Up OvrlD	Third valve board reporting Over Current on level speed up output.	Check third valve board wiring and valve solenoid.
1056	Valve3 H-Dn OvrlD	Third valve board reporting Over Current on high speed down output.	Check third valve board wiring and valve solenoid.
1057	Valve3 H-Up OvrlD	Third valve board reporting Over Current on high speed up output.	Check third valve board wiring and valve solenoid.
1058	Valve3 L-Dn Shrt	Third valve board reporting a Short on level speed down output.	Check third valve board wiring and valve solenoid.
1059	Valve3 L-Up Shrt	Third valve board reporting a Short on level speed up output.	Check third valve board wiring and valve solenoid.
1060	Valve3 H-Dn Shrt	Third valve board reporting a Short on high speed down output.	Check third valve board wiring and valve solenoid.
1061	Valve3 H-Up Shrt	Third valve board reporting a Short on high speed up output.	Check third valve board wiring and valve solenoid.
1062	S-Motor3 Out-Shrt	Motor Start on third valve board is reporting a Short	Check motor start wiring between third valve board and soft starter
1063	Valve3 L-Dn Open	Third valve board reporting Open Circuit on the output.	Check third valve board and wiring.
1064	Valve3 L-Up Open	Third valve board reporting Open Circuit on the output.	Check third valve board and wiring.
1065	Valve3 H-Dn Open	Third valve board reporting Open Circuit on the output.	Check third valve board and wiring.
1066	Valve3 H-Up Open	Third valve board reporting Open Circuit on the output.	Check third valve board and wiring.
1067	H-Speed3 En Fault	Third valve board High Speed Enable Output Failure	Third Valve Board Open or Shorted TRIAC Output
1068	SS4 Input Flt	Discrete input fault 4 from the Soft Starter has been activated.	Check the SS 4 Input fault, and the contact feeding the input from the soft starter.

Fault Number	Name	Description	Troubleshooting Procedure
1069	Valve4 Unk	Fourth valve board reporting an unknown fault.	Check fourth valve board and wiring.
1070	Valve4 POR Rst	Fourth valve board recovering from a reset due to power off.	Check fourth valve board and wiring.
1071	Valve4 WDT Rst	Fourth valve board recovering from reset due to watchdog.	Check fourth valve board and wiring.
1072	Valve4 BOD Rst	Fourth valve board recovering from reset due to voltage dip.	Check fourth valve board and wiring.
1073	Valve4 Comm Loss	Fourth valve board reporting loss of communication with elevator controller.	Check fourth valve board and wiring.
1074	Valve4 Level Dn	Fourth valve board reporting mismatch between valve control and status signals of level speed down output.	Check fourth valve board and wiring.
1075	Valve4 Level Up	Fourth valve board reporting mismatch between valve control and status signals of level speed up output.	Check fourth valve board and wiring.
1076	Valve4 High Dn	Fourth valve board reporting mismatch between valve control and status signals of high speed down output.	Check fourth valve board and wiring.
1077	Valve4 High Up	Fourth valve board reporting mismatch between valve control and status signals of high speed up output.	Check fourth valve board and wiring.
1078	Valve4 SM	Fourth valve board reporting mismatch between control and status signals of the start motor output.	Check fourth valve board and wiring.
1079	Valve4 Inv. Cmd.	Fourth valve board reporting both up and down commands issued at the same time.	Check fourth valve board and wiring.
1080	Valve4 CAN Bus Rst	Fourth valve board reporting a CAN bus reset.	Check fourth valve board and wiring.
1081	Valve4 Offline	Communication lost with fourth valve board.	Check fourth valve board and wiring.
1082	Valve4 Dupl. Addr.	Two fourth valve boards detected on the network.	Check fourth valve board addressing.
1083	Valve4 L-Dn Ovrlld	Fourth valve board reporting Over Current on level speed down output.	Check fourth valve board wiring and valve solenoid.
1084	Valve4 L-Up Ovrlld	Fourth valve board reporting Over Current on level speed up output.	Check fourth valve board wiring and valve solenoid.

<b>Fault Number</b>	<b>Name</b>	<b>Description</b>	<b>Troubleshooting Procedure</b>
1085	Valve4 H-Dn Ovrlid	Fourth valve board reporting Over Current on high speed down output.	Check fourth valve board wiring and valve solenoid.
1086	Valve4 H-Up Ovrlid	Fourth valve board reporting Over Current on high speed up output.	Check fourth valve board wiring and valve solenoid.
1087	Valve4 L-Dn Shrt	Fourth valve board reporting a Short on level speed down output.	Check fourth valve board wiring and valve solenoid.
1088	Valve4 L-Up Shrt	Fourth valve board reporting a Short on level speed up output.	Check fourth valve board wiring and valve solenoid.
1089	Valve4 H-Dn Shrt	Fourth valve board reporting a Short on high speed down output.	Check fourth valve board wiring and valve solenoid.
1090	Valve4 H-Up Shrt	Fourth valve board reporting a Short on high speed up output.	Check fourth valve board wiring and valve solenoid.
1091	S-Motor4 Out-Shrt	Motor Start on fourth valve board is reporting a Short	Check motor start wiring between fourth valve board and soft starter
1092	Valve4 L-Dn Open	Fourth valve board reporting Open Circuit on the output.	Check fourth valve board and wiring.
1093	Valve4 L-Up Open	Fourth valve board reporting Open Circuit on the output.	Check fourth valve board and wiring.
1094	Valve4 H-Dn Open	Fourth valve board reporting Open Circuit on the output.	Check fourth valve board and wiring.
1095	Valve4 H-Up Open	Fourth valve board reporting Open Circuit on the output.	Check fourth valve board and wiring.
1096	H-Speed4 En Fault	Fourth valve board High Speed Enable Output Failure	Fourth Valve Board Open or Shorted TRIAC Output
1097	Oil Over Heat	Oil temperature is great than maximum allowance	Check oil temperature, Oil Overheat Input, then reset the latching fault via the reset button.
1098	OOS Redun. Disp.	The car has been taken out of service because of riser 1 or riser 2 offline.	Check riser 1 or riser 2 status
1100	Emergency Stop	This fault is triggered whenever the Emergency Stop switch input is activated.	Deactivate the Emergency Stop switch

## 2 Alarms

The Alarms menu displays all alarms reported by the system's hardware.

### 2.1 Active Alarms

When an alarm is detected, its type and description appear under the Active Alarms menu.

Follow these steps view the list of Active Alarms:

1. Navigate to **Main Menu | Alarms | Active.**
2. Review the list of alarms.
3. Scroll through the list and press the right button for a detailed description of each alarm.

### 2.2 Logged Alarms

All system alarms are logged. The Logged Alarms menu shows the alarm history – up to 32 entries on the CT and COP boards, and up to 256 on the MR board.

Follow these steps to view the list of Logged Alarms:

1. Navigate to **Main Menu | Alarms | Logged.**
2. Review the list of previously recorded alarms.

### 2.3 Cleared Alarms

The Cleared Alarms option deletes the entire alarm history log.

Follow these steps to Clear the Logged Alarms:

1. Navigate to **Main Menu | Alarms | Clear Log.**
2. Press the right button and select Yes to confirm.

### 2.4 List of Alarms

The table below provides a list of possible system alarms.

Table 3: List of Alarms

Alarm Number	Name	Description	Troubleshooting Procedure
1	NTS Up P1-1	NTS point 1 has been tripped in the up direction for the normal motion profile. The lowest point is closest to the terminal.	NA
2	NTS Up P1-2	NTS point 2 has been tripped in the up direction for the normal	NA

Alarm Number	Name	Description	Troubleshooting Procedure
		motion profile. The lowest point is closest to the terminal.	
3	NTS Up P1-3	NTS point 3 has been tripped in the up direction for the normal motion profile. The lowest point is closest to the terminal.	NA
4	NTS Up P1-4	NTS point 4 has been tripped in the up direction for the normal motion profile. The lowest point is closest to the terminal.	NA
5	NTS Up P1-5	NTS point 5 has been tripped in the up direction for the normal motion profile. The lowest point is closest to the terminal.	NA
6	NTS Up P1-6	NTS point 6 has been tripped in the up direction for the normal motion profile. The lowest point is closest to the terminal.	NA
7	NTS Up P1-7	NTS point 7 has been tripped in the up direction for the normal motion profile. The lowest point is closest to the terminal.	NA
8	NTS Up P1-8	NTS point 8 has been tripped in the up direction for the normal motion profile. The lowest point is closest to the terminal.	NA
9	NTS Up P2-1	NTS point 1 has been tripped in the up direction for the inspection motion profile. The lowest point is closest to the terminal.	NA
10	NTS Up P2-2	NTS point 2 has been tripped in the up direction for the inspection motion profile. The lowest point is closest to the terminal.	NA
11	NTS Up P2-3	NTS point 3 has been tripped in the up direction for the inspection motion profile. The lowest point is closest to the terminal.	NA
12	NTS Up P2-4	NTS point 4 has been tripped in the up direction for the inspection motion profile. The lowest point is closest to the terminal.	NA
13	NTS Up P2-5	NTS point 5 has been tripped in the up direction for the inspection motion profile. The	NA

Alarm Number	Name	Description	Troubleshooting Procedure
		lowest point is closest to the terminal.	
14	NTS Up P2-6	NTS point 6 has been tripped in the up direction for the inspection motion profile. The lowest point is closest to the terminal.	NA
15	NTS Up P2-7	NTS point 7 has been tripped in the up direction for the inspection motion profile. The lowest point is closest to the terminal.	NA
16	NTS Up P2-8	NTS point 8 has been tripped in the up direction for the inspection motion profile. The lowest point is closest to the terminal.	NA
17	NTS Up P3-1	NTS point 1 has been tripped in the up direction for the E-Power motion profile. The lowest point is closest to the terminal.	NA
18	NTS Up P3-2	NTS point 2 has been tripped in the up direction for the E-Power motion profile. The lowest point is closest to the terminal.	NA
19	NTS Up P3-3	NTS point 3 has been tripped in the up direction for the E-Power motion profile. The lowest point is closest to the terminal.	NA
20	NTS Up P3-4	NTS point 4 has been tripped in the up direction for the E-Power motion profile. The lowest point is closest to the terminal.	NA
21	NTS Up P3-5	NTS point 5 has been tripped in the up direction for the E-Power motion profile. The lowest point is closest to the terminal.	NA
22	NTS Up P3-6	NTS point 6 has been tripped in the up direction for the E-Power motion profile. The lowest point is closest to the terminal.	NA
23	NTS Up P3-7	NTS point 7 has been tripped in the up direction for the E-Power motion profile. The lowest point is closest to the terminal.	NA
24	NTS Up P3-8	NTS point 8 has been tripped in the up direction for the E-Power motion profile. The lowest point is closest to the terminal.	NA

Alarm Number	Name	Description	Troubleshooting Procedure
25	NTS Up P4-1	NTS point 1 has been tripped in the up direction for the Short motion profile. The lowest point is closest to the terminal.	NA
26	NTS Up P4-2	NTS point 2 has been tripped in the up direction for the Short motion profile. The lowest point is closest to the terminal.	NA
27	NTS Up P4-3	NTS point 3 has been tripped in the up direction for the Short motion profile. The lowest point is closest to the terminal.	NA
28	NTS Up P4-4	NTS point 4 has been tripped in the up direction for the Short motion profile. The lowest point is closest to the terminal.	NA
29	NTS Up P4-5	NTS point 5 has been tripped in the up direction for the Short motion profile. The lowest point is closest to the terminal.	NA
30	NTS Up P4-6	NTS point 6 has been tripped in the up direction for the Short motion profile. The lowest point is closest to the terminal.	NA
31	NTS Up P4-7	NTS point 7 has been tripped in the up direction for the Short motion profile. The lowest point is closest to the terminal.	NA
32	NTS Up P4-8	NTS point 8 has been tripped in the up direction for the Short motion profile. The lowest point is closest to the terminal.	NA
33	NTS Dn P1-1	NTS point 1 has been tripped in the down direction for the normal motion profile. The lowest point is closest to the terminal.	NA
34	NTS Dn P1-2	NTS point 2 has been tripped in the down direction for the normal motion profile. The lowest point is closest to the terminal.	NA
35	NTS Dn P1-3	NTS point 3 has been tripped in the down direction for the normal motion profile. The lowest point is closest to the terminal.	NA
36	NTS Dn P1-4	NTS point 4 has been tripped in the down direction for the	NA

Alarm Number	Name	Description	Troubleshooting Procedure
		normal motion profile. The lowest point is closest to the terminal.	
37	NTS Dn P1-5	NTS point 5 has been tripped in the down direction for the normal motion profile. The lowest point is closest to the terminal.	NA
38	NTS Dn P1-6	NTS point 6 has been tripped in the down direction for the normal motion profile. The lowest point is closest to the terminal.	NA
39	NTS Dn P1-7	NTS point 7 has been tripped in the down direction for the normal motion profile. The lowest point is closest to the terminal.	NA
40	NTS Dn P1-8	NTS point 8 has been tripped in the down direction for the normal motion profile. The lowest point is closest to the terminal.	NA
41	NTS Dn P2-1	NTS point 1 has been tripped in the down direction for the inspection motion profile. The lowest point is closest to the terminal.	NA
42	NTS Dn P2-2	NTS point 2 has been tripped in the down direction for the inspection motion profile. The lowest point is closest to the terminal.	NA
43	NTS Dn P2-3	NTS point 3 has been tripped in the down direction for the inspection motion profile. The lowest point is closest to the terminal.	NA
44	NTS Dn P2-4	NTS point 4 has been tripped in the down direction for the inspection motion profile. The lowest point is closest to the terminal.	NA
45	NTS Dn P2-5	NTS point 5 has been tripped in the down direction for the inspection motion profile. The lowest point is closest to the terminal.	NA

Alarm Number	Name	Description	Troubleshooting Procedure
46	NTS Dn P2-6	NTS point 6 has been tripped in the down direction for the inspection motion profile. The lowest point is closest to the terminal.	NA
47	NTS Dn P2-7	NTS point 7 has been tripped in the down direction for the inspection motion profile. The lowest point is closest to the terminal.	NA
48	NTS Dn P2-8	NTS point 8 has been tripped in the down direction for the inspection motion profile. The lowest point is closest to the terminal.	NA
49	NTS Dn P3-1	NTS point 1 has been tripped in the down direction for the E-Power motion profile. The lowest point is closest to the terminal.	NA
50	NTS Dn P3-2	NTS point 2 has been tripped in the down direction for the E-Power motion profile. The lowest point is closest to the terminal.	NA
51	NTS Dn P3-3	NTS point 3 has been tripped in the down direction for the E-Power motion profile. The lowest point is closest to the terminal.	NA
52	NTS Dn P3-4	NTS point 4 has been tripped in the down direction for the E-Power motion profile. The lowest point is closest to the terminal.	NA
53	NTS Dn P3-5	NTS point 5 has been tripped in the down direction for the E-Power motion profile. The lowest point is closest to the terminal.	NA
54	NTS Dn P3-6	NTS point 6 has been tripped in the down direction for the E-Power motion profile. The lowest point is closest to the terminal.	NA
55	NTS Dn P3-7	NTS point 7 has been tripped in the down direction for the E-Power motion profile. The lowest point is closest to the terminal.	NA
56	NTS Dn P3-8	NTS point 8 has been tripped in the down direction for the E-Power motion profile. The lowest point is closest to the terminal.	NA
57	NTS Dn P4-1	NTS point 1 has been tripped in the down direction for the Short	NA

Alarm Number	Name	Description	Troubleshooting Procedure
		motion profile. The lowest point is closest to the terminal.	
58	NTS Dn P4-2	NTS point 2 has been tripped in the down direction for the Short motion profile. The lowest point is closest to the terminal.	NA
59	NTS Dn P4-3	NTS point 3 has been tripped in the down direction for the Short motion profile. The lowest point is closest to the terminal.	NA
60	NTS Dn P4-4	NTS point 4 has been tripped in the down direction for the Short motion profile. The lowest point is closest to the terminal.	NA
61	NTS Dn P4-5	NTS point 5 has been tripped in the down direction for the Short motion profile. The lowest point is closest to the terminal.	NA
62	NTS Dn P4-6	NTS point 6 has been tripped in the down direction for the Short motion profile. The lowest point is closest to the terminal.	NA
63	NTS Dn P4-7	NTS point 7 has been tripped in the down direction for the Short motion profile. The lowest point is closest to the terminal.	NA
64	NTS Dn P4-8	NTS point 8 has been tripped in the down direction for the Short motion profile. The lowest point is closest to the terminal.	NA
69	ES Class Op	When 01-150 is set to ON, this debugging alarm will signal when an ESTOP is commanded due to class of operation change.	NA
70	ES Stop Timeout	When 01-150 is set to ON, this debugging alarm will signal when an ESTOP is commanded due to run flag failing to drop.	NA
71	ES Move Timeout	When 01-150 is set to ON, this debugging alarm will signal when an ESTOP is commanded due to failing to start a run.	NA
72	ES Inv Insp	When 01-150 is set to ON, this debugging alarm will signal when an ESTOP is commanded due to invalid inspection mode.	NA
73	ES Recall Dest.	When 01-150 is set to ON, this debugging alarm will signal when	NA

Alarm Number	Name	Description	Troubleshooting Procedure
		an ESTOP is commanded due to invalid recall destination.	
74	ES Stop At Next	When 01-130 is set to ON, this debugging alarm will signal when the car is commanded to stop at next available floor.	NA
75	ES Earthquake	When 01-150 is set to ON, this debugging alarm will signal when an ESTOP is during EQ operation.	NA
76	ES Flood	When 01-150 is set to ON, this debugging alarm will signal when an ESTOP is during flood operation.	NA
77	Stop No DZ	Car is stopped outside of a door zone.	NA
78	Releveling	Car is performing releveling.	NA
79	Defaulting 1-Bit	Defaulting 1-bit parameters.	NA
80	Defaulting 8-Bit	Defaulting 8-bit parameters.	NA
81	Defaulting 16-Bit	Defaulting 16-bit parameters.	NA
82	Defaulting 24-Bit	Defaulting 24-bit parameters.	NA
83	Defaulting 32-Bit	Defaulting 32-bit parameters.	NA
84	Recall Inv Door	Requested recall destination has an invalid door configuration.	NA
85	Recall Inv Floor	Requested recall destination is an invalid floor.	NA
86	Recall Inv Opening	Requested recall destination is not a valid opening.	NA
87	MRA WDT Disabled	Processor has started up with watchdog disabled.	Remove the WD jumper and restart the board to reenale.
88	MRB WDT Disabled	Processor has started up with watchdog disabled.	Remove the WD jumper and restart the board to reenale.
89	CTA WDT Disabled	Processor has started up with watchdog disabled.	Remove the WD jumper and restart the board to reenale.
90	CTB WDT Disabled	Processor has started up with watchdog disabled.	Remove the WD jumper and restart the board to reenale.
91	COPA WDT Disabled	Processor has started up with watchdog disabled.	Remove the WD jumper and restart the board to reenale.
92	COPB WDT Disabled	Processor has started up with watchdog disabled.	Remove the WD jumper and restart the board to reenale.
93 - 96	MR CAN Rst 1-4	Machine room SRU CAN1-4 transceiver has self-reset due to excessive bus errors.	Verify bus wiring. If problem persists, remove boards from the network to isolate the board with the problem transceiver.
97 - 100	CT CAN Rst 1-4	Car top SRU CAN1-4 transceiver has self-reset due to excessive bus errors.	Verify bus wiring. If problem persists, remove boards from the network to isolate the board with the problem transceiver.

Alarm Number	Name	Description	Troubleshooting Procedure
<b>101 - 104</b>	COP CAN Rst 1-4	Car operating panel SRU CAN1-4 transceiver has self-reset due to excessive bus errors.	Verify bus wiring. If problem persists, remove boards from the network to isolate the board with the problem transceiver.
<b>108</b>	Remote PU 1-Bit	The car has received a remote request to change a 1-bit parameter.	NA
<b>109</b>	Remote PU 8-Bit	The car has received a remote request to change a 8-bit parameter.	NA
<b>110</b>	Remote PU 16-Bit	The car has received a remote request to change a 16-bit parameter.	NA
<b>111</b>	Remote PU 24-Bit	The car has received a remote request to change a 24-bit parameter.	NA
<b>112</b>	Remote PU 32-Bit	The car has received a remote request to change a 32-bit parameter.	NA
<b>115</b>	Inv Man Run Door	Manual run request rejected due to invalid car door state.	NA
<b>116</b>	Inv Man Run Lock	Manual run request rejected due to invalid hall lock state.	NA
<b>117</b>	Inv Man Run Arm	Manual run request rejected due to disarmed direction inputs. This may occur if car enters inspection with its direction inputs active.	NA
<b>120</b>	Inv Man Run DOBF	Manual run request rejected due to front door open button request.	NA
<b>121</b>	Inv Man Run DOBR	Manual run request rejected due to rear door open button request.	NA
<b>122</b>	Inv Man Run HA	Manual run request rejected due to invalid hoistway access floor or opening configuration.	NA
<b>123</b>	Inv Man Run CT En	Manual run request rejected due to missing CT enable signal.	NA
<b>124</b>	Idle Dir Timeout	Car has been idle with a valid destination for the user configured timeout (08-202) and has been forced to change direction.	124
<b>125</b>	CPLD Offline MR	Debugging communication timer with MR CPLD elapsed.	NA
<b>126</b>	CPLD Offline CT	Debugging communication timer with CT CPLD elapsed.	NA
<b>127</b>	CPLD Offline COP	Debugging communication timer with COP CPLD elapsed.	NA

Alarm Number	Name	Description	Troubleshooting Procedure
128	No Dest Stop	The car is in motion, but its destination has been canceled. There are no reachable alternative destinations. It will ramp down at the next available landing and reassess. This can occur in cases where a hall call is reassigned to a closer car. This will not occur if 01-00196 is ON.	128
129	Flood Switch	The flood switch has been activated.	129
130	Remote PU Backup	The car has received a remote request to change parameters in a bulk parameter restore format.	NA
131	Dup EP InterGroup	A Duplicate Group Priority was Detected	NA
132 - 139	I-Group 1-8 No Connection	Connection was lost for Inter Group 1-8	NA
140	I-Group0 Stat Rcvd	Intergroup status packet received by group with priority 0.	NA
141	CCB Secured	Pressed Car Call Button is secured.	Check security options to verify if the CCB should or should not be secured.
146	Mode Changed	When 01-129 is ON, this debug alarm will be set when the mode of operation changes.	NA
147	RIS1 Offline	Riser1 marked as offline after 30 seconds without communication.	NA
148	RIS1 Unk	Riser1 reporting an unknown error.	NA
149	RIS1 POR Rst	Riser1 reporting a power-on reset error.	NA
150	RIS1 WDT Rst	Riser1 reporting a watchdog reset error.	NA
151	RIS1 BOD Rst	Riser1 reporting a brown-out reset error.	NA
152	RIS1 Group Net	Riser1 reporting a group network communication loss error.	NA
153	RIS1 Hall Net	Riser1 reporting a hall network communication loss error.	NA
154	RIS1 Car Net	Riser1 reporting an invalid error.	NA
155	RIS1 Mst Net	Riser1 reporting an invalid error.	NA
156	RS1 Slv Net	Riser1 reporting an invalid error.	NA
157	RIS1 DIP	Riser1 has detected another board with the same address.	NA
158	RIS1 Bus Rst 1	Riser1 reporting a CAN1 bus reset error.	NA
159	RIS1 Bus Rst 2	Riser1 reporting a CAN2 bus reset error.	NA

Alarm Number	Name	Description	Troubleshooting Procedure
161	RIS1 Inv Msg 2	Riser 1 communication lost with a hall board that was previously on the network	NA
162	RIS2 Offline	Riser2 marked as offline after 30 seconds without communication.	NA
163	RIS2 Unk	Riser2 reporting an unknown error.	NA
164	RIS2 POR Rst	Riser2 reporting a power-on reset error.	NA
165	RIS2 WDT Rst	Riser2 reporting a watchdog reset error.	NA
166	RIS2 BOD Rst	Riser2 reporting a brown-out reset error.	NA
167	RIS2 Group Net	Riser2 reporting a group network communication loss error.	NA
168	RIS2 Hall Net	Riser2 reporting a hall network communication loss error.	NA
169	RIS2 Car Net	Riser2 reporting an invalid error.	NA
170	RIS2 Mst Net	Riser2 reporting an invalid error.	NA
171	RS1 Slv Net	Riser2 reporting an invalid error.	NA
172	RIS2 DIP	Riser2 has detected another board with the same address.	NA
173	RIS2 Bus Rst 1	Riser2 reporting a CAN1 bus reset error.	NA
174	RIS2 Bus Rst 2	Riser2 reporting a CAN2 bus reset error.	NA
176	RIS2 Inv Msg 2	Riser 2 communication lost with a hall board that was previously on the network	NA
177	RIS3 Offline	Riser3 marked as offline after 30 seconds without communication.	NA
178	RIS3 Unk	Riser3 reporting an unknown error.	NA
179	RIS3 POR Rst	Riser3 reporting a power-on reset error.	NA
180	RIS3 WDT Rst	Riser3 reporting a watchdog reset error.	NA
181	RIS3 BOD Rst	Riser3 reporting a brown-out reset error.	NA
182	RIS3 Group Net	Riser3 reporting a group network communication loss error.	NA
183	RIS3 Hall Net	Riser3 reporting a hall network communication loss error.	NA
184	RIS3 Car Net	Riser3 reporting an invalid error.	NA
185	RIS3 Mst Net	Riser3 reporting an invalid error.	NA
186	RS1 Slv Net	Riser3 reporting an invalid error.	NA

Alarm Number	Name	Description	Troubleshooting Procedure
187	RIS3 DIP	Riser3 has detected another board with the same address.	NA
188	RIS3 Bus Rst 1	Riser3 reporting a CAN1 bus reset error.	NA
189	RIS3 Bus Rst 2	Riser3 reporting a CAN2 bus reset error.	NA
191	RIS3 Inv Msg 2	Riser 3 communication lost with a hall board that was previously on the network	NA
192	RIS4 Offline	Riser4 marked as offline after 30 seconds without communication.	NA
193	RIS4 Unk	Riser4 reporting an unknown error.	NA
194	RIS4 POR Rst	Riser4 reporting a power-on reset error.	NA
195	RIS4 WDT Rst	Riser4 reporting a watchdog reset error.	NA
196	RIS4 BOD Rst	Riser4 reporting a brown-out reset error.	NA
197	RIS4 Group Net	Riser4 reporting a group network communication loss error.	NA
198	RIS4 Hall Net	Riser4 reporting a hall network communication loss error.	NA
199	RIS4 Car Net	Riser4 reporting an invalid error.	NA
200	RIS4 Mst Net	Riser4 reporting an invalid error.	NA
201	RS1 Slv Net	Riser4 reporting an invalid error.	NA
202	RIS4 DIP	Riser4 has detected another board with the same address.	NA
203	RIS4 Bus Rst 1	Riser4 reporting a CAN1 bus reset error.	NA
204	RIS4 Bus Rst 2	Riser4 reporting a CAN2 bus reset error.	NA
206	RIS4 Inv Msg 2	Riser 4 communication lost with a hall board that was previously on the network	NA
207 - 214	Dispatch T/O C1-8	Time to dispatch Car (1-8) expired.	NA
215 - 222	Dispatch T/O X1-8	Time to dispatch XREG Car (1-8) expired.	NA
223 - 230	XREG Offline 1-8	XREG Car (1-8) offline.	NA
232 - 298	MRA RT M1-67	Module runtime limit exceeded for MRA module index 1-67.	NA
299 - 362	MRB RT M1-64	Module runtime limit exceeded for MRB module index 1-64.	NA
363 - 427	CTA RT M1-65	Module runtime limit exceeded for CTA module index 1-65.	NA

Alarm Number	Name	Description	Troubleshooting Procedure
428 - 491	CTB RT M1-64	Module runtime limit exceeded for CTB module index 1-64.	NA
492 - 555	COPA RT M1-64	Module runtime limit exceeded for COPA module index 1-64.	NA
556 - 619	COPB RT M1-64	Module runtime limit exceeded for COPB module index 1-64.	NA
620 - 627	Car Offline 1-8	Car (1-8) offline.	NA
628	DDM Offline	DD Panel manager board has gone offline.	Check DD manager board wiring.
629	Door Open In Motion	Test alarm signaling that both locks and gsw are open while in motion. Enabled with 01-159.	NA
631	DO During Run	Debugging alarm signaling that DO output asserted during a run. Will not flag if decelerating, in stop sequence, or releveling.	NA
632	In Dest DZ During Run	Debugging alarm signaling that the flag preventing DO is being lost during a run. Will not flag if decelerating, in stop sequence, or releveling.	NA
633 - 640	Dupl. MR 501-508	Specified terminal exceeds the two-duplicate limit per input function.	Clear the terminal's function.
641 - 656	Dupl. CT 501-516	Specified terminal exceeds the two-duplicate limit per input function.	Clear the terminal's function.
657 - 672	Dupl. COP 501 - 516	Specified terminal exceeds the two-duplicate limit per input function.	Clear the terminal's function.
673 - 680	Dupl. RIS1 501 - 508	Specified terminal exceeds the two-duplicate limit per input function.	Clear the terminal's function.
681 - 688	Dupl. RIS2 501 - 508	Specified terminal exceeds the two-duplicate limit per input function.	Clear the terminal's function.
689 - 696	Dupl. RIS3 501 - 508	Specified terminal exceeds the two-duplicate limit per input function.	Clear the terminal's function.
697 - 704	Dupl. RIS4 501 - 508	Specified terminal exceeds the two-duplicate limit per input function.	Clear the terminal's function.
705 - 712	Dupl. EXP1 501 - 508	Specified terminal exceeds the two-duplicate limit per input function.	Clear the terminal's function.
713 - 720	Dupl. EXP2 501 - 508	Specified terminal exceeds the two-duplicate limit per input function.	Clear the terminal's function.

Alarm Number	Name	Description	Troubleshooting Procedure
721 - 728	Dupl. EXP3 501 - 508	Specified terminal exceeds the two-duplicate limit per input function.	Clear the terminal's function.
729 - 736	Dupl. EXP4 501 - 508	Specified terminal exceeds the two-duplicate limit per input function.	Clear the terminal's function.
737 - 744	Dupl. EXP5 501 - 508	Specified terminal exceeds the two-duplicate limit per input function.	Clear the terminal's function.
745 - 752	Dupl. EXP6 501 - 508	Specified terminal exceeds the two-duplicate limit per input function.	Clear the terminal's function.
753 - 760	Dupl. EXP7 501 - 508	Specified terminal exceeds the two-duplicate limit per input function.	Clear the terminal's function.
761 - 768	Dupl. EXP8 501 - 508	Specified terminal exceeds the two-duplicate limit per input function.	Clear the terminal's function.
769 - 776	Dupl. EXP9 501 - 508	Specified terminal exceeds the two-duplicate limit per input function.	Clear the terminal's function.
777 - 784	Dupl. EXP10 501 - 508	Specified terminal exceeds the two-duplicate limit per input function.	Clear the terminal's function.
785 - 792	Dupl. EXP11 501 - 508	Specified terminal exceeds the two-duplicate limit per input function.	Clear the terminal's function.
793 - 800	Dupl. EXP12 501 - 508	Specified terminal exceeds the two-duplicate limit per input function.	Clear the terminal's function.
801 - 808	Dupl. EXP13 501 - 508	Specified terminal exceeds the two-duplicate limit per input function.	Clear the terminal's function.
809 - 816	Dupl. EXP14 501 - 508	Specified terminal exceeds the two-duplicate limit per input function.	Clear the terminal's function.
817 - 824	Dupl. EXP15 501 - 508	Specified terminal exceeds the two-duplicate limit per input function.	Clear the terminal's function.
825 - 832	Dupl. EXP16 501 - 508	Specified terminal exceeds the two-duplicate limit per input function.	Clear the terminal's function.
833 - 840	Dupl. EXP17 501 - 508	Specified terminal exceeds the two-duplicate limit per input function.	Clear the terminal's function.
841 - 848	Dupl. EXP18 501 - 508	Specified terminal exceeds the two-duplicate limit per input function.	Clear the terminal's function.

Alarm Number	Name	Description	Troubleshooting Procedure
849 - 856	Dupl. EXP19 501 - 508	Specified terminal exceeds the two-duplicate limit per input function.	Clear the terminal's function.
857 - 864	Dupl. EXP20 501 - 508	Specified terminal exceeds the two-duplicate limit per input function.	Clear the terminal's function.
865 - 872	Dupl. EXP21 501 - 508	Specified terminal exceeds the two-duplicate limit per input function.	Clear the terminal's function.
873 - 880	Dupl. EXP22 501 - 508	Specified terminal exceeds the two-duplicate limit per input function.	Clear the terminal's function.
881 - 888	Dupl. EXP23 501 - 508	Specified terminal exceeds the two-duplicate limit per input function.	Clear the terminal's function.
889 - 896	Dupl. EXP24 501 - 508	Specified terminal exceeds the two-duplicate limit per input function.	Clear the terminal's function.
897 - 904	Dupl. EXP25 501 - 508	Specified terminal exceeds the two-duplicate limit per input function.	Clear the terminal's function.
905 - 912	Dupl. EXP26 501 - 508	Specified terminal exceeds the two-duplicate limit per input function.	Clear the terminal's function.
913 - 920	Dupl. EXP27 501 - 508	Specified terminal exceeds the two-duplicate limit per input function.	Clear the terminal's function.
921 - 928	Dupl. EXP28 501 - 508	Specified terminal exceeds the two-duplicate limit per input function.	Clear the terminal's function.
929 - 936	Dupl. EXP29 501 - 508	Specified terminal exceeds the two-duplicate limit per input function.	Clear the terminal's function.
937 - 944	Dupl. EXP30 501 - 508	Specified terminal exceeds the two-duplicate limit per input function.	Clear the terminal's function.
945 - 952	Dupl. EXP31 501 - 508	Specified terminal exceeds the two-duplicate limit per input function.	Clear the terminal's function.
953 - 960	Dupl. EXP32 501 - 508	Specified terminal exceeds the two-duplicate limit per input function.	Clear the terminal's function.
961 - 968	Dupl. EXP33 501 - 508	Specified terminal exceeds the two-duplicate limit per input function.	Clear the terminal's function.
969 - 976	Dupl. EXP34 501 - 508	Specified terminal exceeds the two-duplicate limit per input function.	Clear the terminal's function.

Alarm Number	Name	Description	Troubleshooting Procedure
977 - 984	Dupl. EXP35 501 - 508	Specified terminal exceeds the two-duplicate limit per input function.	Clear the terminal's function.
985 - 992	Dupl. EXP36 501 - 508	Specified terminal exceeds the two-duplicate limit per input function.	Clear the terminal's function.
993 - 1000	Dupl. EXP37 501 - 508	Specified terminal exceeds the two-duplicate limit per input function.	Clear the terminal's function.
1001 - 1008	Dupl. EXP38 501 - 508	Specified terminal exceeds the two-duplicate limit per input function.	Clear the terminal's function.
1009 - 1016	Dupl. EXP39 501 - 508	Specified terminal exceeds the two-duplicate limit per input function.	Clear the terminal's function.
1017 - 1024	Dupl. EXP40 501 - 508	Specified terminal exceeds the two-duplicate limit per input function.	Clear the terminal's function.
1025 - 1032	Dupl. MR 601 - 608	Specified terminal exceeds the two-duplicate limit per output function.	Clear the terminal's function.
1033 - 1048	Dupl. CT 601 - 616	Specified terminal exceeds the two-duplicate limit per output function.	Clear the terminal's function.
1049 - 1064	Dupl. COP 601 - 616	Specified terminal exceeds the two-duplicate limit per output function.	Clear the terminal's function.
1065 - 1072	Dupl. RIS1 601 - 608	Specified terminal exceeds the two-duplicate limit per output function.	Clear the terminal's function.
1073 - 1080	Dupl. RIS2 601 - 608	Specified terminal exceeds the two-duplicate limit per output function.	Clear the terminal's function.
1081 - 1088	Dupl. RIS3 601 - 608	Specified terminal exceeds the two-duplicate limit per output function.	Clear the terminal's function.
1089 - 1096	Dupl. RIS4 601 - 608	Specified terminal exceeds the two-duplicate limit per output function.	Clear the terminal's function.
1097 - 1104	Dupl. EXP1 601 - 608	Specified terminal exceeds the two-duplicate limit per output function.	Clear the terminal's function.
1105 - 1112	Dupl. EXP2 601 - 608	Specified terminal exceeds the two-duplicate limit per output function.	Clear the terminal's function.
1113 - 1120	Dupl. EXP3 601 - 608	Specified terminal exceeds the two-duplicate limit per output function.	Clear the terminal's function.

Alarm Number	Name	Description	Troubleshooting Procedure
1121 - 1128	Dupl. EXP4 601 - 608	Specified terminal exceeds the two-duplicate limit per output function.	Clear the terminal's function.
1129 - 1136	Dupl. EXP5 601 - 608	Specified terminal exceeds the two-duplicate limit per output function.	Clear the terminal's function.
1137 - 1144	Dupl. EXP6 601 - 608	Specified terminal exceeds the two-duplicate limit per output function.	Clear the terminal's function.
1145 - 1152	Dupl. EXP7 601 - 608	Specified terminal exceeds the two-duplicate limit per output function.	Clear the terminal's function.
1153 - 1160	Dupl. EXP8 601 - 608	Specified terminal exceeds the two-duplicate limit per output function.	Clear the terminal's function.
1161 - 1168	Dupl. EXP9 601 - 608	Specified terminal exceeds the two-duplicate limit per output function.	Clear the terminal's function.
1169 - 1176	Dupl. EXP10 601 - 608	Specified terminal exceeds the two-duplicate limit per output function.	Clear the terminal's function.
1177 - 1184	Dupl. EXP11 601 - 608	Specified terminal exceeds the two-duplicate limit per output function.	Clear the terminal's function.
1185 - 1192	Dupl. EXP12 601 - 608	Specified terminal exceeds the two-duplicate limit per output function.	Clear the terminal's function.
1193 - 1200	Dupl. EXP13 601 - 608	Specified terminal exceeds the two-duplicate limit per output function.	Clear the terminal's function.
1201 - 1208	Dupl. EXP14 601 - 608	Specified terminal exceeds the two-duplicate limit per output function.	Clear the terminal's function.
1209 - 1216	Dupl. EXP15 601 - 608	Specified terminal exceeds the two-duplicate limit per output function.	Clear the terminal's function.
1217 - 1224	Dupl. EXP16 601 - 608	Specified terminal exceeds the two-duplicate limit per output function.	Clear the terminal's function.
1225 - 1232	Dupl. EXP17 601 - 608	Specified terminal exceeds the two-duplicate limit per output function.	Clear the terminal's function.
1233 - 1240	Dupl. EXP18 601 - 608	Specified terminal exceeds the two-duplicate limit per output function.	Clear the terminal's function.
1241 - 1248	Dupl. EXP19 601 - 608	Specified terminal exceeds the two-duplicate limit per output function.	Clear the terminal's function.

Alarm Number	Name	Description	Troubleshooting Procedure
1249 - 1256	Dupl. EXP20 601 - 608	Specified terminal exceeds the two-duplicate limit per output function.	Clear the terminal's function.
1257 - 1264	Dupl. EXP21 601 - 608	Specified terminal exceeds the two-duplicate limit per output function.	Clear the terminal's function.
1265 - 1272	Dupl. EXP22 601 - 608	Specified terminal exceeds the two-duplicate limit per output function.	Clear the terminal's function.
1273 - 1280	Dupl. EXP23 601 - 608	Specified terminal exceeds the two-duplicate limit per output function.	Clear the terminal's function.
1281 - 1288	Dupl. EXP24 601 - 608	Specified terminal exceeds the two-duplicate limit per output function.	Clear the terminal's function.
1289 - 1296	Dupl. EXP25 601 - 608	Specified terminal exceeds the two-duplicate limit per output function.	Clear the terminal's function.
1297 - 1304	Dupl. EXP26 601 - 608	Specified terminal exceeds the two-duplicate limit per output function.	Clear the terminal's function.
1305 - 1312	Dupl. EXP27 601 - 608	Specified terminal exceeds the two-duplicate limit per output function.	Clear the terminal's function.
1313 - 1320	Dupl. EXP28 601 - 608	Specified terminal exceeds the two-duplicate limit per output function.	Clear the terminal's function.
1321 - 1328	Dupl. EXP29 601 - 608	Specified terminal exceeds the two-duplicate limit per output function.	Clear the terminal's function.
1329 - 1336	Dupl. EXP30 601 - 608	Specified terminal exceeds the two-duplicate limit per output function.	Clear the terminal's function.
1337 - 1344	Dupl. EXP31 601 - 608	Specified terminal exceeds the two-duplicate limit per output function.	Clear the terminal's function.
1345 - 1352	Dupl. EXP32 601 - 608	Specified terminal exceeds the two-duplicate limit per output function.	Clear the terminal's function.
1353 - 1360	Dupl. EXP33 601 - 608	Specified terminal exceeds the two-duplicate limit per output function.	Clear the terminal's function.
1361 - 1368	Dupl. EXP34 601 - 608	Specified terminal exceeds the two-duplicate limit per output function.	Clear the terminal's function.
1369 - 1376	Dupl. EXP35 601 - 608	Specified terminal exceeds the two-duplicate limit per output function.	Clear the terminal's function.

Alarm Number	Name	Description	Troubleshooting Procedure
1377 - 1384	Dupl. EXP36 601 - 608	Specified terminal exceeds the two-duplicate limit per output function.	Clear the terminal's function.
1385 - 1392	Dupl. EXP37 601 - 608	Specified terminal exceeds the two-duplicate limit per output function.	Clear the terminal's function.
1393 - 1400	Dupl. EXP38 601 - 608	Specified terminal exceeds the two-duplicate limit per output function.	Clear the terminal's function.
1401 - 1408	Dupl. EXP39 601 - 608	Specified terminal exceeds the two-duplicate limit per output function.	Clear the terminal's function.
1409 - 1416	Dupl. EXP40 601 - 608	Specified terminal exceeds the two-duplicate limit per output function.	Clear the terminal's function.
1418	DL20 Offline CT	Communication with DL20 fixture and car top SRU has been lost.	Check wiring and power to DL20.
1419	DL20 Offline COP	Communication with DL20 fixture and car operating panel SRU has been lost.	Check wiring and power to DL20.
1420	CPLD OVF MR	CPLD communication buffers have been overrun.	Contact smartrise support.
1421	CPLD OVF CT	CPLD communication buffers have been overrun.	Contact smartrise support.
1422	CPLD OVF COP	CPLD communication buffers have been overrun.	Contact smartrise support.
1423	Fire Key Main	Fire phase 1 has been activated by the main fire key switch.	Check the fire input and riser board status.
1424	Fire Key Remote	Fire phase 1 has been activated by the remote fire key switch.	Check the fire input and riser board status.
1425	Fire Smoke Main	Fire phase 1 has been activated by the main smoke input.	Check the fire input and riser board status.
1426	Fire Smoke Alt	Fire phase 1 has been activated by the alternate smoke input.	Check the fire input and riser board status.
1427	Fire Smoke MR	Fire phase 1 has been activated by the machine room smoke input.	Check the fire input and riser board status.
1428	Fire Smoke HA	Fire phase 1 has been activated by the hoistway smoke input.	Check the fire input and riser board status.
1429	Fire Smoke Latched	Fire phase 1 has been activated by a latched fire recall source following a power loss.	Check the fire input and riser board status.
1430	Fire Smoke Pit	Fire phase 1 has been activated by the pit smoke input.	Check the fire input and riser board status.
1431	Fire Smoke MR 2	Fire phase 1 has been activated by the second machine room smoke input.	Check the fire input and riser board status.

Alarm Number	Name	Description	Troubleshooting Procedure
1432	Fire Smoke HA 2	Fire phase 1 has been activated by the second hoistway smoke input.	Check the fire input and riser board status.
1433	NEED TO RST MR	Machine room SRU board needs to be reset.	Cycle power to the machine room SRU board.
1434	NEED TO RST CT	Car top SRU board needs to be reset.	Cycle power to the car top SRU board.
1435	NEED TO RST COP	Car operating panel SRU board needs to be reset.	Cycle power to the car operating panel SRU board.
1437	Dupar COP Offline	Communication has been lost between Dupar COP and COP SRU.	Check wiring between Dupar COP and COP SRU (C3H/C3L)
1438	RIS1 HB Offline	Riser 1 has reported communication loss with one of its hall boards.	Check the hall board status menu for a hall board reporting 0% communication and check wiring.
1439	RIS2 HB Offline	Riser 2 has reported communication loss with one of its hall boards.	Check the hall board status menu for a hall board reporting 0% communication and check wiring.
1440	RIS3 HB Offline	Riser 3 has reported communication loss with one of its hall boards.	Check the hall board status menu for a hall board reporting 0% communication and check wiring.
1441	RIS4 HB Offline	Riser 4 has reported communication loss with one of its hall boards.	Check the hall board status menu for a hall board reporting 0% communication and check wiring.
1442	Shield Unknown	Shield error state is unknown.	Check wiring of power and network lines.
1443	Shield POR Rst	Shield is starting up after a standard reset event.	Check wiring of power and network lines.
1444	Shield BOD Rst	Shield is starting up after a brown out reset event.	Check wiring of power and network lines.
1445	Shield WDT Rst	Shield is starting up after a watchdog timer reset event.	Check wiring of power and network lines.
1446	Shield COM Group	Shield has not seen communication from the group network in 5 seconds.	Check wiring of power and network lines.
1447	Shield COM RPi	Shield has not seen communication from the RPi in 5 seconds.	Check wiring of power and network lines.
1448	Shield Failed RTC	Shield RTC has failed.	Replace on board battery.
1449	Shield UART OVF TX	Shield UART transmit buffer has overflowed.	Contact smartrise support.
1450	Shield UART OVF RX	Shield UART receive buffer has overflowed.	Contact smartrise support.
1451	Shield CAN OVF TX	Shield CAN transmit buffer has overflowed.	Contact smartrise support.
1452	Shield CAN OVF RX	Shield CAN receive buffer has overflowed.	Contact smartrise support.

Alarm Number	Name	Description	Troubleshooting Procedure
1453	Shield CAN Bus Rst	Shield has detected a can bus reset event.	Check wiring of power and network lines.
1454	VIP Timeout	VIP process has been canceled due to excessive wait time.	NA
1455	Fire Virtual Remote Recall	Fire phase 1 has been activated by Virtual Input Fire Remote Recall	NA
1456	EMS2 Not At Recall	Car is on EMS phase 2, in a dead zone with doors open, but can't exit EMS 2 because it is not at the correct recall floor (the floor it was first called to on EMS phase 1).	Either move car to the correct EMS 1 recall floor or turn ON parameter EMS_ExitPh2AtAnyFloor (01-98) to allow exiting EMS phase 2 at any floor.
1460	Invalid Buffer Speed	While attempting to do the Buffer Test, Buffer speed is 0 or less than Learn Speed.	Set the Buffer Speed to a higher FPM (Contract Speed or above Learn Speed).
1461	Invalid Asc/Des Speed	While attempting to do the Asc/Des Overspeed test, Asc/Des speed is 0 or less than Learn Speed.	Set the Asc/Des speed to a higher FPM (Contract Speed or above Learn Speed).
1462	CEDES1 COMM	Primary CEDES camera channel 1 reporting a communication error.	Check wiring and network termination.
1463	CEDES1 READ	Primary CEDES camera channel 1 reporting a cannot read tape error.	Clean camera window, clean tape, check alignment.
1464	CEDES1 CLOSE	Primary CEDES camera channel 1 reporting a tape too close error.	Fix tape alignment.
1465	CEDES1 FAR	Primary CEDES camera channel 1 reporting a tape too far error.	Fix tape alignment.
1466	CEDES1 LEFT	Primary CEDES camera channel 1 reporting a tape too far left error.	Fix tape alignment.
1467	CEDES1 RIGHT	Primary CEDES camera channel 1 reporting a tape too far right error.	Fix tape alignment.
1468	CEDES1 CONTRAST1	Primary CEDES camera channel 1 reporting a contrast - service recommended read status.	Clean camera window, clean tape, check alignment.
1469	CEDES1 CONTRAST2	Primary CEDES camera channel 1 reporting a contrast - warning read status.	Clean camera window, clean tape, check alignment.
1470	CEDES1 CONTRAST3	Primary CEDES camera channel 1 reporting a contrast - stopped read status.	Clean camera window, clean tape, check alignment.
1471	CEDES1 CRC	Primary CEDES camera channel 1 failed CRC check.	Check wiring and network termination.

Alarm Number	Name	Description	Troubleshooting Procedure
1472	CEDES2 COMM	Primary CEDES camera channel 2 reporting a communication error.	Check wiring and network termination.
1473	CEDES2 READ	Primary CEDES camera channel 2 reporting a cannot read tape error.	Clean camera window, clean tape, check alignment.
1474	CEDES2 CLOSE	Primary CEDES camera channel 2 reporting a tape too close error.	Fix tape alignment.
1475	CEDES2 FAR	Primary CEDES camera channel 2 reporting a tape too far error.	Fix tape alignment.
1476	CEDES2 LEFT	Primary CEDES camera channel 2 reporting a tape too far left error.	Fix tape alignment.
1477	CEDES2 RIGHT	Primary CEDES camera channel 2 reporting a tape too far right error.	Fix tape alignment.
1478	CEDES2 CONTRAST1	Primary CEDES camera channel 2 reporting a contrast - service recommended read status.	Clean camera window, clean tape, check alignment.
1479	CEDES2 CONTRAST2	Primary CEDES camera channel 2 reporting a contrast - warning read status.	Clean camera window, clean tape, check alignment.
1480	CEDES2 CONTRAST3	Primary CEDES camera channel 2 reporting a contrast - stopped read status.	Clean camera window, clean tape, check alignment.
1481	CEDES2 CRC	Primary CEDES camera channel 2 failed CRC check.	Check wiring and network termination.
1492	DAD Offline	DAD unit has stopped communicating with the C4 car for 15 seconds.	Check group network wiring. Check that power is supplied to the DAD unit.
1493	SS Offline	Communication lost with primary soft starter.	Check primary soft starter board and wiring.
1494	SS Unk	Primary soft starter reporting an unknown fault.	Check primary soft starter board and wiring.
1495	SS POR Rst	Primary soft starter recovering from a reset due to power off.	Check primary soft starter board and wiring.
1496	SS WDT Rst	Primary soft starter recovering from reset due to watchdog.	Check primary soft starter board and wiring.
1497	SS BOD Rst	Primary soft starter recovering from reset due to voltage dip.	Check primary soft starter board and wiring.
1498	SS Comm Loss	Primary soft starter reporting loss of communication with the elevator controller.	Check primary soft starter board and wiring.
1499	SS OC	Primary soft starter reporting an overcurrent error.	Check primary soft starter board and wiring.
1500	SS OVV	Primary soft starter reporting an overvoltage error.	Check primary soft starter board and wiring.
1501	SS UNDV	Primary soft starter reporting an undervoltage error.	Check primary soft starter board and wiring.

Alarm Number	Name	Description	Troubleshooting Procedure
1502	SS Phase Miss	Primary soft starter reporting a missing phase.	Check primary soft starter board and wiring.
1503	SS Phase Seq	Primary soft starter reporting phase sequence error.	Check primary soft starter board and wiring.
1504	SS CAN Bus Rst	Primary soft starter reporting a CAN bus reset.	Check primary soft starter board and wiring.
1505	SS Input Flt	Discrete input fault 2 from the Soft Starter has been activated.	Check the SS 2 Input fault, and the contact feeding the input from the drive.
1506	SS2 Offline	Communication lost with secondary soft starter.	Check secondary soft starter board and wiring.
1507	SS2 Unk	Secondary soft starter reporting an unknown fault.	Check secondary soft starter board and wiring.
1508	SS2 POR Rst	Secondary soft starter recovering from a reset due to power off.	Check secondary soft starter board and wiring.
1509	SS2 WDT Rst	Secondary soft starter recovering from reset due to watchdog.	Check secondary soft starter board and wiring.
1510	SS2 BOD Rst	Secondary soft starter recovering from reset due to voltage dip.	Check secondary soft starter board and wiring.
1511	SS2 Comm Loss	Secondary soft starter reporting loss of communication with the elevator controller.	Check secondary soft starter board and wiring.
1512	SS2 OC	Secondary soft starter reporting an overcurrent error.	Check secondary soft starter board and wiring.
1513	SS2 OVV	Secondary soft starter reporting an overvoltage error.	Check secondary soft starter board and wiring.
1514	SS2 UNDV	Secondary soft starter reporting an undervoltage error.	Check secondary soft starter board and wiring.
1515	SS2 Phase Miss	Secondary soft starter reporting a missing phase.	Check secondary soft starter board and wiring.
1516	SS2 Phase Seq	Secondary soft starter reporting phase sequence error.	Check secondary soft starter board and wiring.
1517	SS2 CAN Bus Rst	Secondary soft starter reporting a CAN bus reset.	Check secondary soft starter board and wiring.
1518	SS2 Input Flt	Discrete input fault 2 from the Soft Starter has been activated.	Check the SS 2 Input fault, and the contact feeding the input from the drive.
1519	SS ADDR	Primary soft starter reporting another board on the network has the same address.	Check primary soft starter address DIP switches.
1520	SS2 ADDR	Secondary soft starter reporting another board on the network has the same address.	Check secondary soft starter address DIP switches.
1521	Fire2 Hold	If the car is on fire phase 2 operation, and not at the recall floor. When the in car fire key switch is turned to the OFF position, the car will be put in a	Return the car to the recall floor before exiting phase 2.

Alarm Number	Name	Description	Troubleshooting Procedure
		Fire Phase 2 Hold state if option Fire__Phase2ExitOnlyAtRecallFlr (01-0017) is ON. This alarm informs the user that they should move the car back to the recall floor before attempting to exit phase 2.	
1522	RCL MOVE	The car has attempted to move to a recall floor but failed to start movement within 5 seconds.	This alarm is for diagnostics and does not require immediate Smartrise support unless accompanied by other recall related issues.
1523	SLWDN LRN T/O	The car has failed to slow down to configured leveling speed during a slowdown learn within 10 seconds of cutting the high-speed valve. Set the car's leveling speed parameter to above the car's max leveling valve speed.	This alarm is for identifying when the car's leveling speed is not set above the car's leveling speed.
1532	CAN1 OVF MRA	The CAN1 buffer on MRA has overflowed. Investigate CN1+/- network issues.	Check CN1 +/- network wiring and termination.
1533	CAN1 OVF CTA	The CAN1 buffer on CTA has overflowed. Investigate CN1+/- network issues.	Check CN1 +/- network wiring and termination.
1534	CAN1 OVF COPA	The CAN1 buffer on COPA has overflowed. Investigate CN1+/- network issues.	Check CN1 +/- network wiring and termination.
1535	Normal Limit Reached	The car has reached the normal limits of either the bottom or top door zone.	Move the car away from the Normal Limit.
1536	Touchscreen Offline	Communication has been lost between Touchscreen/COP and COP SRU.	Check wiring between Touchscreen/COP and COP SRU (C3H/C3L)
1537	HB Configuration	This alarm appears when Param. 01-0195 and Param. 01-0225 aren't equal.	Review parameter 01-0195 and 01-0225
1538	SS3 Input Flt	Discrete input fault 3 from the Soft Starter has been activated.	Check the SS 2 Input fault, and the contact feeding the input from the drive.
1539	CC Button Stuck Active	A car call button is stuck active while not pressed down	Check whether any car call button is experiencing an input stuck on condition while the button is not being actively pressed.
1540	FINAL Limit Bypassed	BFL or TFL is bypassed	Check if BFL/TFL is connected directly to 120VAC and wire it through the BFL/TFL switch
1541	Phone Failure	Phone failure input has been activated.	Check phone failure input wiring.

<b>Alarm Number</b>	<b>Name</b>	<b>Description</b>	<b>Troubleshooting Procedure</b>
<b>1542</b>	Phase Fault Input	Phase fault input has been activated on learn and manual classes of operation	Check Phase fault input

*Page intentionally left blank.*

---

# **SYSTEM CONFIGURATIONS**

---

## 1 Adjusting Run Timers

Start and end-run timers are used to optimize run quality for each car. Adjustments may be required based on the start and stop sequences.

**SM1 Pick Delay:** Delays the time between activating the primary start motor output and activating a valve when moving in the up direction.

- ◆ If the delay is too long, the motor may start without oil in the valve, causing an initial jerking motion.
- ◆ If the delay is too short, motor and valve activation may overlap, resulting in a jerking motion due to excess oil flow.
  - **Adjustment Range:** 0 – 12.75 seconds
  - **Default:** 50 ms
  - **Unit:** ms

**SM2 Pick Delay:** Delays the time between activating the secondary start motor output and the primary start motor output. This delay is skipped if a secondary soft starter is not used.

- ◆ If the delay is too long, the car may start slowly or not at all, and the motor may draw excess current.
- ◆ If the delay is too short, a jerking motion may occur during startup.
  - **Adjustment Range:** 0 – 12.75 seconds
  - **Default:** 50 ms
  - **Unit:** ms

**Delta Pick Delay:** Delays the time between activating the delta output and activating the valve outputs.

- **Adjustment Range:** 0 – 12.75 seconds

**Pump Off Delay:** Delays the time between deactivating the valves and turning off the start pump motor outputs.

- ◆ If the delay is too long, the motor will continue running with no oil to pump.
- ◆ If the delay is too short or set to zero, residual oil may remain in the pump.
  - **Adjustment Range:** 0 – 12.75 seconds
  - **Default:** 50 ms
  - **Unit:** ms

**Safe Drop Delay:** Delays the time between deactivating the pump motor and deactivating the SAFE output from the MR board.

- **Adjustment Range:** 0 – 12.75 seconds
- **Default:** 50 ms
- **Unit:** ms

### Adjustment Procedure:

1. Navigate to **Main Menu | Setup | Run Timers**.
2. Select either **Start Timers** or **Stop Timers**:
  - i. To adjust start-of-run timers, click **Start Timers** and proceed to Step 3.
  - ii. To adjust end-of-run timers, click **Stop Timers** and proceed to Step 4.
3. For **Safe Pick Delay**, **SM Pick Delay**, or **Delta Pick Delay**, select the desired timer and adjust the value. Proceed to Step 5.
4. For **Pump Off Delay** or **Safe Drop Delay**, scroll to the desired timer and adjust the value.
5. Scroll right and press **Save**.

## 2 Floors/Releveling

This section outlines the procedures for configuring floor/releveling settings.

### 2.1 Short Floor Opening

A Short Floor is defined as a floor with a door zone that overlaps the door zone of the preceding floor. For example, if Floor 5 and Floor 6 have overlapping door zones, Floor 6 must be configured as a short floor.

Follow the steps below to set the Short Floor Opening:

1. Navigate to **Main Menu | Setup | Floors | Short Floor Opening**.
2. Select the short floor.
3. Scroll right and press **Save**.

### 2.2 Enable Releveling

Refer to section 15.1.3 Enable Releveling.

### 2.3 Relevel Zone Size

Refer to section 15.1.2 Relevel Zone Size.

### 2.4 Releveling Delay

Refer to section 15.1.4 Relevel Delay.

## 3 Doors

This section outlines the procedures for configuring door settings.

### 3.1 Door Symbols

The table below lists the symbols used to represent each door state.

Table 4: Door Symbols by State

State	Symbol
Unknown	"[?]"
Closed	"[ ]"
Closed With DC	"> <"
Opening	"[<>]"
Opening With GSW	"[< >]"
Opening With PHE	"[<*>]"
Open	"[ ]"
Open With DO	"< >"
Open With PHE	"[ * ]"
Open With PHE DO	"< * >"
Partially Open	"[   ]"
Partially Open with PHE	"[  * ]"
Closing	"[><]"
Closing With GSW	"[> <]"
Closing With PHE	"[>*<]"
Nudging	"[>!<]"

### 3.2 Control Doors

Doors can be manually controlled to open, close, or nudge as needed.

Follow the steps below to manually control the doors:

1. Navigate to **Main Menu | Setup | Door Setup | Control Doors**.
2. From the **CONTROL DOORS** menu:
  - Under the **CLOSE** option, issue a Door Close command to either the Front or Rear doors.
  - Under the **OPEN** option, issue a Door Open command to either the Front or Rear doors.
  - Under the **NUDGE** option, issue a Nudge command to the Front or Rear door.

### 3.3 Door Dwell Timer

The Door Dwell Timer defines the duration that car doors remain open when responding to car calls.

Follow the steps below to set the Door Dwell Timer:

1. Navigate to **Main Menu | Setup | Door Setup | Door Dwell Timer**.
2. Set the time the doors stay open
3. Scroll right and press **Save**.

### 3.4 Hall Dwell Timer

The Hall Dwell Timer defines the duration in which the doors remain open when responding to hall calls.

Follow the steps below to set the Hall Dwell Timer:

1. Navigate to **Main Menu | Setup | Door Setup | Hall Dwell Timer**.
2. Set the time the doors stay open.
3. Scroll right and press **Save**.

### 3.5 ADA Dwell Timer

The ADA (Americans with Disabilities Act) timer sets the duration that doors remain open when responding to calls from passengers with disabilities.

Follow the steps below to set the ADA Dwell Timer:

1. Navigate to **Main Menu | Setup | Door Setup | ADA Dwell Timer**.
2. Set the time the doors stay open.
3. Scroll right and press **Save**.

### 3.6 Hold Dwell Timer

The Hold Dwell Timer defines the duration in which the doors remain open after the Door Hold button has been pressed.

Follow the steps below to set the Hold Dwell Timer:

1. Navigate to **Main Menu | Setup | Door Setup | Hold Dwell Timer**.
2. Set the time the doors stay open.
3. Scroll right and press **Save**.

### 3.7 Lobby Dwell Timer

The Lobby Dwell Timer defines the duration in which the doors remain open when responding to calls at the lobby.

Follow the steps below to set the Lobby Dwell Timer:

1. Navigate to **Main Menu | Setup | Door Setup | Lobby Dwell Timer**.
2. Set the time the doors stay open.
3. Scroll right and press **Save**.

### 3.8 Door Stuck Timer

The Door Stuck Timer defines the duration for the doors to completely open or close before a fault is issued.

Follow the steps below to set the Door Stuck Timer:

1. Navigate to **Main Menu | Setup | Door Setup | Door Stuck Timer**.
2. Set the time the doors completely close or open before a fault is issued.
3. Scroll right and press **Save**.

### 3.9 Door Nudge Timer

The Door Nudge Timer defines the duration after which the doors attempt to close if held open beyond a specified time. If set to zero, the nudge function is disabled.

Follow the steps below the set the Door Nudge Timer:

1. Navigate to **Main Menu | Setup | Door Setup | Door Nudge Timer**.
2. Set the duration after which the door attempts to close once the door open period has elapsed.
3. Scroll right and press **Save**.

### 3.10 Rear Doors

Rear Doors can be configured as **enabled** or **disabled**. When enabled, rear doors open at designated landings.

Follow the steps below to enable Rear Doors:

1. Navigate to **Main Menu | Setup | Door Setup | Rear Doors**.
2. Set to **On**.
  - If set to **Off**, the rear doors do not open.
3. Scroll right and press **Save**.

### 3.11 PreOpening Distance

The Preopening Distance defines how far before the landing the doors begin to open.

- Door opening is limited by the door zone (DZ) signal.
- If the preopening distance is set outside the range of the DZ signal, the doors will begin opening as soon as the DZ becomes active.

Follow the steps below to set the Preopening Distance:

1. Navigate to **Main Menu | Setup | Door Setup | Preopening Distance**.

2. Set the distance from the landing at which the doors begin to open.
3. Scroll right and press **Save**.

### 3.12 DC On Run

The DC On Run feature activates the door close output while the car is in motion. This function is useful for door systems that require continuous pressure to prevent relaxation during travel.

Follow the steps below to set the DC On Run:

1. Navigate to **Main Menu | Setup | Door Setup | DC On Run**.
2. Set to **On** to enable the doors to close while the car is in motion.
3. Scroll right and press **Save**.

### 3.13 DC On Close

The DC On Close feature activates the door close output while the doors are in a closed state. This function is useful for door systems that require continuous pressure to prevent relaxation.

Follow the steps below to set the DC On Close:

1. Navigate to **Main Menu | Setup | Door Setup | DC On Close**.
2. Set to **On** to enable the doors to close.
3. Scroll right and press **Save**.

### 3.14 DO On Open

The DO On Open feature activates the door open output while the doors are in an open state. This function is useful for door systems that require continuous pressure to prevent relaxation.

Follow the steps below to set the DO On Open:

1. Navigate to **Main Menu | Setup | Door Setup | DO On Open**.
2. Set to **On** to enable the doors to open.
3. Scroll right and press **Save**.

### 3.15 Disable on CT Stop

All door outputs are disabled when the top CT Stop Switch is activated.

Follow the steps below to disable all door outputs:

1. Navigate to **Main Menu | Setup | Door Setup | Disable On CT Stop**.

2. Set to **On** to disable all door outputs.
3. Scroll right and press **Save**.

### 3.16 Disable on HA

All door outputs are disabled when the Hoistway Access (HA) is active.

Follow the steps below to disable all door outputs:

1. Navigate to **Main Menu | Setup | Door Setup | Disable On HA**.
2. Set to **On** to disable all door outputs.
3. Scroll right and press **Save**.

### 3.17 AT400 Doors

AT400 Doors should be enabled when configured with an AT400 door operator.

Follow the steps below to enable the AT400 interface:

1. Navigate to **Main Menu | Setup | Door Setup | AT400 Doors**.
2. Set to **On**.
3. Scroll right and press **Save**.

### 3.18 No Demand Doors Open

The No Demand Doors Open option allows the car doors to stay open while the car is idle.

Follow the steps below to set the doors to remain open while the car is idle:

1. Navigate to **Main Menu | Setup | Door Setup | No Demand DO**.
2. Set to **On** to keep the doors open while the car is idle.
3. Scroll right and press **Save**.

### 3.19 Jumper Timer

The Jumper Timer monitors whether the GSW or door locks remain jumped. If a jumper is detected beyond the configured time, a fault is triggered. The configured time is added to a fixed 1.6-second timeout before a fault occurs.

Follow the steps below to set the Jumper Timer:

1. Navigate to **Main Menu | Setup | Door Setup | Jumper Timer**.
2. Set the time allowed to verify that no jumpers are connected to the GSW or door locks.

3. Scroll right and press **Save**.

### 3.20 Jumper on DOL

The Door Open Limit (DOL) and Gate Switch (GSW) provide signals to indicate whether the door is open or closed. When Jumper on DOL is enabled, the controller checks for a jumper on the open DOL instead of the GSW.

Follow the steps below to enable Jumper Detection on DOL:

1. Navigate to **Main Menu | Setup | Door Setup | Jumper On DOL**.
2. Set to **On** to verify jumpers are detected on the DOL.
3. Scroll right and press **Save**.

### 3.21 Hourly Fault Limit

The Hourly Fault sets the maximum number of door faults permitted within a one-hour period before the car is taken out of service.

Follow the steps below to set the Hourly Fault Limit:

1. Navigate to **Main Menu | Setup | Door Setup | Hourly Fault Limit**.
2. Set the number of logged faults allowed per hour before the car goes out of service.
3. Scroll right and press **Save**.

### 3.22 Nudge – Buzzer Only

When enabled, the Nudge (NDG) output is disabled during nudging, and only the buzzer is activated.

Follow the steps below to only enable the Buzzer during Nudging:

1. Navigate to **Main Menu | Setup | Door Setup | Nudge – Buzzer Only**.
2. Set to **On**.
3. Scroll right and press **Save**.

### 3.23 Opening Time

The Opening Time defines the duration required for a door to go from fully closed to fully open. This value allows the controller to estimate door movement timing during preflight operation.

Follow the steps below to set the time to fully open the doors:

1. Navigate to **Main Menu | Setup | Door Setup | Opening Time**.
2. Set the time for the doors to fully open.

3. Scroll right and press **Save**.

### 3.24 Check Time

The Check Time defines the duration that doors must be verified as safe before the car is permitted to operate in automatic mode.

Follow the steps below to set the Check Time:

1. Navigate to **Main Menu | Setup | Door Setup | Check Time**.
2. Set the check time.
3. Scroll right and press **Save**.

### 3.25 Door Type

The Door Type defines the configuration of doors used at the front or rear landings. The controller can be configured with different door types for all front landings and all rear landings.

Available door types include:

- Automatic
- Freight
- Manual
- Swing

Follow the steps below to select the Front or Rear Door type:

1. Navigate to **Main Menu | Setup | Door Setup | Door Type (Front or Rear)**.
2. Select the type of door used on the front landing and the type of door used on the rear landing as applicable.
3. Scroll right and press **Save**.

### 3.26 Lock and CAM Timeout

Sets the timeout that accounts for the delay between CAM activation and Lock engagement on manual doors.

- If set to zero, the value defaults to 4 seconds.

Follow the steps below to set the lockout time for Lock and CAM:

1. Navigate to **Main Menu | Setup | Door Setup | Lock and CAM Timeout**.
2. Set the duration for the timeout.
3. Scroll right and press **Save**.

### 3.27 Retiring CAM

When set to ON, the CAM output controls hall interlocks. When set to OFF, interlocks are controlled by the door operator.

Follow the steps below to enable the Retiring CAM:

1. Navigate to **Main Menu | Setup | Door Setup | Retiring CAM**.
2. Set to **On**.
3. Scroll right and press **Save**.

### 3.28 Fixed CAM

When set to ON, the door uses a Fixed Hall CAM.

- The car is permitted to start a run without hall locks (hall closed contacts are still required).
- The car can move for the duration set in **08-137 (TimeoutLockAndCAM\_100ms)** before a fault is triggered.
- If the value in 08-137 is set to zero, the default timeout is 4 seconds.

Follow the steps below to enable the Fixed CAM:

1. Navigate to **Main Menu | Setup | Door Setup | Fixed CAM**.
2. Set to **On**.
3. Scroll right and press **Save**.

### 3.29 Swing Lock GSW Timeout

Sets the timeout between GSW and Locks. If the value is zero, the timeout defaults to 500 ms.

Follow the steps below to set the Swing Lock Gate Timeout:

1. Navigate to **Main Menu | Setup | Door Setup | Swing Lock GSW Timeout**.
2. Set the timeout value.
3. Scroll right and press **Save**.

### 3.30 Swing Contacts Timeout

Sets the timeout between CAM activation and closed contact confirmation. If the value is zero, the timeout defaults to 500 ms.

Follow the steps below to set the Swing Contacts Timeout:

1. Navigate to **Main Menu | Setup | Door Setup | Swing Contacts Timeout**.
2. Set the timeout value.

3. Scroll right and press **Save**.

### 3.31 Disable DOB Rear

When set to ON, the rear DOB will be disabled.

Follow the steps below to disable the Rear DOB:

1. Navigate to **Main Menu | Setup | Door Setup | Disable DOB Rear**.
2. Set to **On**.
3. Scroll right and press **Save**.

### 3.32 Front Door State

The Front Door State displays the current operational state of the car when the front door is opening.

Follow the steps below to view the state of the Front Door:

1. Navigate to **Main Menu | Debug | View Debug Data**.
2. Press the right button.
3. Scroll up and right until code 043 is displayed.
4. View the state of the front door.

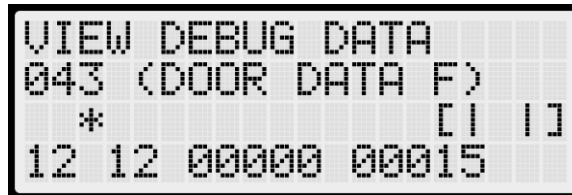

Figure 17: VIEW DEBUG DATA Menu – Front Door

The **Door State** menus display the following:

- **Front or Rear Door State:** Displays the current symbol representing the state of the door (see section 3.1 Door Symbols).
- **Current Door Command:** The current door command being issued to the door module (see the table below).
- **Last Door Command:** The last door command issued to the door module (see the table below).
- **Current Door Timer:** A counter measuring the time elapsed before a door state transition. Each count equals 200 ms.
- **Door Timer Limit:** The threshold the Current Door Timer must reach before transitioning to the next door state. Each count equals 200 ms.

The table below lists the door command issued to the Door Module.

Table 5: Door Command Issued to the Door Module

Command Index	Door Command
0	None
1	OPEN UI REQUEST
2	OPEN IN CAR REQUEST
3	OPEN ADA MODE
4	OPEN SABBATH MODE
5	OPEN HALL REQUEST
6	OPEN HOLD REQUEST
7	OPEN CONSTANT PRESSURE
8	CLOSE
9	CLOSE CONSTANT PRESSURE
10	NUDGE
11	NUDGE CONSTANT PRESSURE
12	FAULT
13	OPEN HOLD DWELL REQUEST
14	OPEN LOBBY REQUEST
15	OPEN RECALL DWELL REQUEST

### 3.33 Rear Door State

The rear door state displays the current operational state of the car when the rear door is opening.

Follow the steps below to view the state of the rear door:

1. Navigate to **Main Menu | Debug | View Debug Data**.
2. Press the right button.
3. Scroll up and right until code 044 is displayed.
4. View the state of the rear door.

See section **3.32 Front Door State** for the door state, commands, and command descriptions.

## 4 Car Data

Car Data provides important dispatching and car status information shared among grouped cars. This data is useful for debugging dispatching issues.

### 4.1 Car Data Overview

Follow the steps below to view the car status overview:

1. Navigate to **Main Menu | Debug | Car Data**.
2. View the Car Data Overview Status.

```

CAR1 - ON [M]      >
A-NORM - IN GRP  ISR
C-10 D-12 R-11 M-UP
[>|>] [>|<]      P-DN

```

Figure 18: Car Data Overview Status

The **Car Data Overview** menu includes the following:

- ◆ **Car ID:** Displays the ID number of the selected car (valid range: 1–8).
- ◆ **Online Status:** Displays **ON** if the car is online and broadcasting on the group network; otherwise, displays **OFF**.
- ◆ **Master Status:** Displays **[M]** if acting as the master dispatcher for the group.
- ◆ **Class and Mode of Operation:** Displays the class of operation as a single-letter abbreviation, followed by the mode of operation.
- ◆ **In Group Status:** Displays **IN GRP** if the car is in group and currently accepting Hall Calls.
- ◆ **ISR Flags:** Displays flags based on current conditions.
  - **[I]** Car is idle and can perform a direction change.
  - **[S]** Car is stopped or decelerating.
  - **[R]** Door reopening is blocked in preparation for a run.
  - **[.]** Default state if no condition above is met.
- ◆ **Current Landing:** Displays current landing number, prefixed with **C-**.
- ◆ **Destination Landing:** Displays destination landing number, prefixed with **D-**.
- ◆ **Reachable Landing:** Displays estimated closest reachable landing number, prefixed with **R-**.
- ◆ **Motion Status:** Displays motion status.
  - **M-UP:** Moving up
  - **M-DN:** Moving down
  - **M-ST:** Stationary
- ◆ **Direction Priority:** Displays direction priority.
  - **P-UP:** Serving Up Calls
  - **P-DN:** Serving Down Calls

Refer to the table below for a list of Car Status codes.

Table 6: Car Status Codes

Code	Description
<b>Unknown</b>	
U-UNK	Unknown
<b>Manual</b>	
M-UNK	Unknown
M-INV	Invalid
M-NON	None
M-CT	Car Top Inspection
M-IC	In-Car Inspection
M-HA	Hoistway Access
M-MR	Machine Room Inspection
M-PIT	Pit Inspection
M-LND	Landing Inspection
M-CON	Construction
M-HAT	Hoistway Access (Top)
M-HAB	Hoistway Access (Bottom)
<b>Learn</b>	
L-UNK	Unknown
L-INV	Invalid
L-NON	None
L-G <sub>2</sub> T	Go to A Terminal
L-RB <sub>1</sub>	L-SSD (code)
L-RB <sub>2</sub>	L-LSD (code)
L-BHA	Bypass Term Limits
L-RHA	Hold UP/DN To Start
L-LB <sub>1</sub>	L-SSU (code)
L-LB <sub>2</sub>	L-LSU (code)
L-LHU	Learning BTM To TOP
L-LHD	Learning TOP To BTM
L-EBP	L-LHU (code)
L-INV	L-LHD (code)
L-CMP	Learn Complete
<b>Automatic</b>	
A-UNK	Unknown
A-NON	None
A-NORM	Normal
A-FIR <sub>1</sub>	Fire Phase 1
A-FIR <sub>2</sub>	Fire Phase 2
A-EMS <sub>1</sub>	EMS Phase 1
A-EMS <sub>2</sub>	EMS Phase 2
A-ATTD	Attendant
A-INDP	Independent Service
A-SEIS	Seismic
A-CWDR	Counterweight Derail
A-SABB	Sabbath
A-EPWR	Emergency Power
A-EVAC	Invalid
A-OOS	Out of Service
A-C2L	Car To Lobby

A-BATR	Battery Rescue
A-PRS1	Prison Transport 1
A-PRS2	Prison Transport 2
A-R2F	Recall To Floor
A-WG	Wander Guard
A-HUGS	HUGS
A-ER2F	Emergency Recall
A-TEST	Test Mode
A-WIND	Wind Operation
A-FLD	Flood Operation
A-SWING	Swing Operation
A-CUST	Custom Operation
A-ACTS	Code: A-SHOO
A-MARS	Marshal Mode
A-VIP	VIP Mode
A-T2T	Normal Terminal To Terminal
A-F2F	Normal Floor To Floor
A-RAND	Normal Random
A-STI	Shunt Trip Mode

### 4.2 Hall Call Mask Status

Hall Call Mask Status displays the status of Front, Rear, and Latchable Hall Calls.

Follow the steps below to view the Hall Call Mask Status:

1. Navigate to **Main Menu | Debug | Car Data**.
2. From the Car Data Overview Status, press the right button.
3. View the Hall Mask Status.

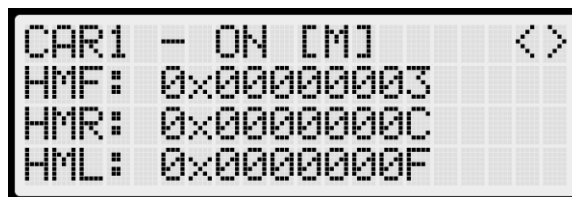

Figure 19: Hall Mask Status

The table below lists the Hall Mask Status definitions.

Table 7: Hall Mask Status Definitions

Hall Mask Code	Definition	Description
HMF	Front Hall Mask	Marks which Front Hall Calls can be taken
HMR	Rear Hall Mask	Marks which Rear Hall Calls can be taken
HML	Latchable Hall Mask	Marks which Hall Calls can be latched

### 4.3 Opening Map Status

The Opening Map Status displays which landings have Front or Rear openings enabled.

#### 4.3.1 Front Opening Map Status

Follow the steps below to view the Front Opening Map Status:

1. Navigate to **Main Menu | Debug | Car Data**.
2. From the Car Data Overview Status, press the right button.
3. From the Hall Mask Status, press the right button.
4. View the Front Opening Map Status.

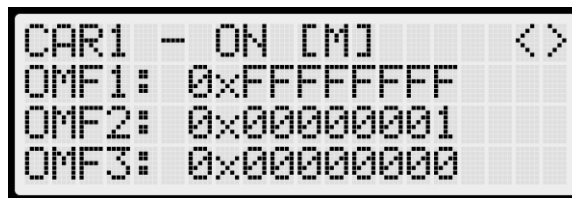

Figure 20: Front Opening Map Status

- **Opening Map Front 1 (OMF1)** represents the hex value for the first 32 landings that have Front openings.
- **OMF2** represents landings 33-64 with Front openings.
- **OMF3** represents landings 65-96 with Front openings.

#### 4.3.2 Rear Opening Map Status

Follow the steps below to view the Rear Opening Map Status:

1. Navigate to **Main Menu | Debug | Car Data**.
2. From the Car Data Overview Status, press the right button.
3. From the Hall Mask Status, press the right button.
4. From the Front Opening Map Status, press the right button.
5. View the Rear Opening Map Status.

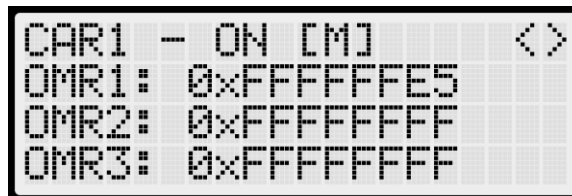

Figure 21: Rear Opening Map Status

- **Opening Map Rear 1 (OMR1)** represents the hex value for the first 32 landings that have Rear openings.

- **OMR2** represents landings 33-64 with Rear openings.
- **OMR3** represents landings 65-96 with Rear openings.

## 4.4 Security Map Status

The Security Map Status displays the status of secured landings.

### 4.4.1 Front Security Map Status

Follow the steps below to view the Front Security Map Status:

1. Navigate to **Main Menu | Debug | Car Data**.
2. From the Car Data Overview Status, press the right button.
3. From the Hall Mask Status, press the right button.
4. From the Front Opening Map Status, press the right button.
5. From the Rear Opening Map Status, press the right button.
6. View the Front Security Map Status.

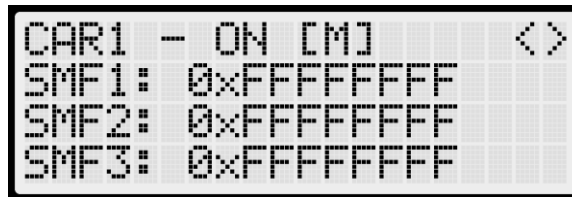

Figure 22: Front Security Map Status

- **Security Map Front 1 (SMF1)** represents the hex value for the first 32 Front openings that have security enabled.
- **SMF2** represents Front openings 33-64 with security enabled.
- **SMF3** represents Front openings 65-96 with security enabled.

### 4.4.2 Rear Security Map Status

Follow the steps below to view the Rear Security Map Status:

1. Navigate to **Main Menu | Debug | Car Data**.
2. From the Car Data Overview Status, press the right button.
3. From the Hall Mask Status, press the right button.
4. From the Front Opening Map Status, press the right button.
5. From the Rear Opening Map Status, press the right button.
6. From the Front Security Map Status, press the right button.

- View the Rear Security Map Status.



Figure 23: Rear Security Map Status

- **Security Map Rear 1 (SMR1)** represents the hex value for the first 32 Rear openings that have security enabled.
- **SMR2** represents Rear openings 33-64 with security enabled.
- **SMR3** represents Rear openings 65-96 with security enabled.

#### 4.5 Linked Hall Mask Status

Linked Hall Call Masks are used to tie together the lamps of separate Hall Buttons. Each paired mask must be set to the sum of the Hall Call Masks for the corresponding paired boards. The parameter addresses for the paired Hall Call Masks are located at **08-0178 to 08-0181**. For a full list of parameters, refer to the **Hydro:Evolved Parameter List**.

The **Linked Hall Mask Status** indicates which Hall Board outputs are tied together.

Follow the steps below to view the Linked Hall Mask Status:

- Navigate to **Main Menu | Debug | Car Data**.
- From the Car Data Overview Status, press the right button.
- From the Hall Mask Status, press the right button.
- From the Front Opening Map Status, press the right button.
- From the Rear Opening Map Status, press the right button.
- From the Front Security Map Status, press the right button.
- From the Rear Security Map Status, press the right button.
- View the Linked Hall Mask Status.

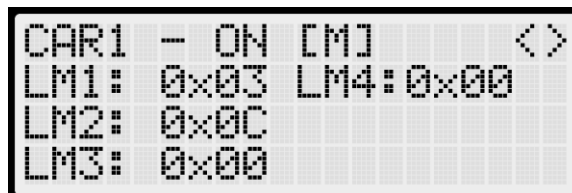

Figure 24: Linked Hall Mask Status

- **First Mask (LM1)** pairs the Front Hall Call boards.

- **Second Mask (LM2)** pairs the Rear Hall Call boards.

## 4.6 Hall Security Map Status

The Hall Security Map identifies the landings that require Hall Security Contacts.

- **Front Hall Security Map** parameters are located at **16-0940 to 16-0945**.
- **Rear Hall Security Map** parameters are located at **16-1035 to 16-1040**.

For a complete list of parameters, refer to the **Hydro:Evolved Parameter List**.

### 4.6.1 Front Hall Security Map Status

Follow the steps below to view the Front Hall Security Map Status:

1. Navigate to **Main Menu | Debug | Car Data**.
2. From the Car Data Overview Status, press the right button.
3. From the Hall Mask Status, press the right button.
4. From the Front Opening Map Status, press the right button.
5. From the Rear Opening Map Status, press the right button.
6. From the Front Security Map Status, press the right button.
7. From the Rear Security Map Status, press the right button.
8. From the Linked Hall Mask Status, press the right button.
9. View the Front Hall Security Map Status.

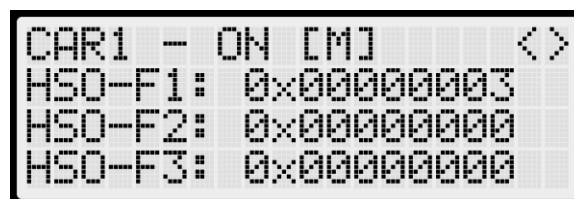

Figure 25: Front Hall Security Map Status

### 4.6.2 Rear Hall Security Map Status

Follow the steps below to view the Rear Hall Security Map Status:

1. Navigate to **Main Menu | Debug | Car Data**.
2. From the Car Data Overview Status, press the right button.
3. From the Hall Mask Status, press the right button.
4. From the Front Opening Map Status, press the right button.

5. From the Rear Opening Map Status, press the right button.
6. From the Front Security Map Status, press the right button.
7. From the Rear Security Map Status, press the right button.
8. From the Linked Hall Mask Status, press the right button.
9. From the Front Hall Security Map Status, press the right button.
10. View the Rear Hall Security Map Status.

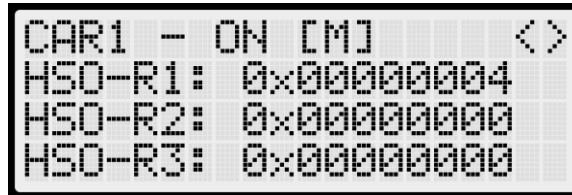

Figure 26: Rear Hall Security Map Status

#### 4.7 Hall Security Mask Status

The Hall Security Mask displays the status of all enabled secured Hall Calls.

The **Hall Security Bypass Status (BYP)** is **ON** when Hall Security is disabled. This occurs if the **Enable Hall Security** option is **OFF** (parameter **01-0138**) or if the **Enable All HC** input is programmed and active.

For a complete list of parameters, refer to the **Hydro:Evolved Parameter List**.

Follow the steps below to view the Hall Security Mask Status:

1. Navigate to **Main Menu | Debug | Car Data**.
2. From the Car Data Overview Status, press the right button.
3. From the Hall Mask Status, press the right button.
4. From the Front Opening Map Status, press the right button.
5. From the Rear Opening Map Status, press the right button.
6. From the Front Security Map Status, press the right button.
7. From the Rear Security Map Status, press the right button.
8. From the Linked Hall Mask Status, press the right button.
9. From the Front Hall Security Map Status, press the right button.
10. From the Rear Hall Security Map Status, press the right button.

11. View the Hall Security Mask Status.



Figure 27: Front and Rear Hall Security Mask Status

#### 4.8 Dispatching Timer Status

The Dispatching Timer Status displays the configured amount of time a car has to respond to Hall Calls before being removed from the group.

Follow the steps below to view the Dispatching Timer Status:

1. Navigate to **Main Menu | Debug | Car Data**.
2. From the Car Data Overview Status, press the right button.
3. From the Hall Mask Status, press the right button.
4. From the Front Opening Map Status, press the right button.
5. From the Rear Opening Map Status, press the right button.
6. From the Front Security Map Status, press the right button.
7. From the Rear Security Map Status, press the right button.
8. From the Linked Hall Mask Status, press the right button.
9. From the Front Hall Security Map Status, press the right button.
10. From the Rear Hall Security Map Status, press the right button.
11. From the Hall Security Mask Status, press the right button.
12. View the Dispatching Timer Status.

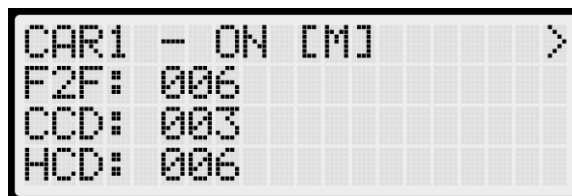

Figure 28: Dispatching Timers Status

- **F2F:** Estimated worst-case Floor-to-Floor travel time.

- **CCD:** Duration that doors remain open when responding to Car Calls (see section **3.3 Door Dwell Timer**).
- **HCD:** Duration that doors remain open when responding to Hall Calls (see section **3.4 Hall Dwell Timer**).

## 4.9 VIP Flags

VIP Flags indicate the status of VIP Mode for the car within the group.

Follow the steps below to view the VIP Flags:

1. Navigate to **Main Menu | Debug | Car Data**.
2. From the Car Data Overview Status, press the right button.
3. From the Hall Mask Status, press the right button.
4. From the Front Opening Map Status, press the right button.
5. From the Rear Opening Map Status, press the right button.
6. From the Front Security Map Status, press the right button.
7. From the Rear Security Map Status, press the right button.
8. From the Linked Hall Mask Status, press the right button.
9. From the Front Hall Security Map Status, press the right button.
10. From the Rear Hall Security Map Status, press the right button.
11. From the Hall Security Mask Status, press the right button.
12. From the Dispatching Timer Status, press the right button.
13. View the VIP Flag Status.



```
CAR1 - ON [M] <>
bVIP: 000
bCarCapture: 000
bCarReady: 000
```

Figure 29: VIP Flags Status

- **bVIP:** Set to 1 when VIP Mode is enabled.
- **bCarCapture:** Set to 1 when the car is being captured in preparation for a VIP call assignment.
- **bCarReady:** Set to 1 when the car is captured and ready to receive a VIP call assignment.

## 4.10 VIP Masks

VIP Masks define which Hall Riser functions the car can serve while in VIP Mode.

Follow the steps below to view the VIP Masks:

1. Navigate to **Main Menu | Debug | Car Data**.
2. From the Car Data Overview Status, press the right button.
3. From the Hall Mask Status, press the right button.
4. From the Front Opening Map Status, press the right button.
5. From the Rear Opening Map Status, press the right button.
6. From the Front Security Map Status, press the right button.
7. From the Rear Security Map Status, press the right button.
8. From the Linked Hall Mask Status, press the right button.
9. From the Front Hall Security Map Status, press the right button.
10. From the Rear Hall Security Map Status, press the right button.
11. From the Hall Security Mask Status, press the right button.
12. From the Dispatching Timer Status, press the right button.
13. From the VIP Flag Status, press the right button.
14. View the VIP Mask Status.

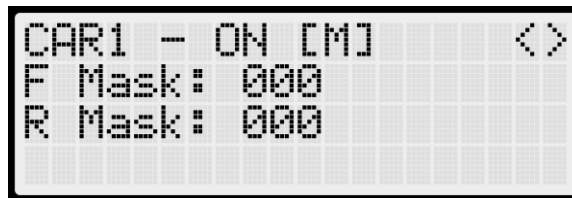

Figure 30: VIP Mask Status

## 4.11 Car Call Enable Bitmap Status

Displays the Car Call Enable signals – signals that bypass Car Call Security – active on the car in bitmap form. Each bit represents either a front or rear opening for a specific group landing.

### 4.11.1 Front Car Call Enable Bitmap Status

Follow the steps below to view the Front Car Call Enable Bitmap Status:

1. Navigate to **Main Menu | Debug | Car Data**.
2. From the Car Data Overview Status, press the right button.

3. From the Hall Mask Status, press the right button.
4. From the Front Opening Map Status, press the right button.
5. From the Rear Opening Map Status, press the right button.
6. From the Front Security Map Status, press the right button.
7. From the Rear Security Map Status, press the right button.
8. From the Linked Hall Mask Status, press the right button.
9. From the Front Hall Security Map Status, press the right button.
10. From the Rear Hall Security Map Status, press the right button.
11. From the Hall Security Mask Status, press the right button.
12. From the Dispatching Timer Status, press the right button.
13. From the VIP Flag Status, press the right button.
14. From the VIP Mask Status, press the right button.
15. View the Front Car Call Enable Bitmap Status.

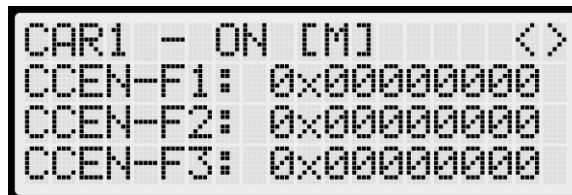

Figure 31: Front Car Call Enable Bitmap Status

#### 4.11.2 Rear Car Call Enable Bitmap Status

Follow the steps below to view the Rear Car Call Enable Bitmap Status:

1. Navigate to **Main Menu | Debug | Car Data**.
2. From the Car Data Overview Status, press the right button.
3. From the Hall Mask Status, press the right button.
4. From the Front Opening Map Status, press the right button.
5. From the Rear Opening Map Status, press the right button.
6. From the Front Security Map Status, press the right button.

7. From the Rear Security Map Status, press the right button.
8. From the Linked Hall Mask Status, press the right button.
9. From the Front Hall Security Map Status, press the right button.
10. From the Rear Hall Security Map Status, press the right button.
11. From the Hall Security Mask Status, press the right button.
12. From the Dispatching Timer Status, press the right button.
13. From the VIP Flag Status, press the right button.
14. From the VIP Mask Status, press the right button.
15. From the Front Car Call Enable Bitmap Status, press the right button.
16. View the Rear Car Call Enable Bitmap Status.



Figure 32: Rear Car Call Enable Bitmap Status Menu

#### 4.12 Emergency Medical Call Mask and Landing

The Emergency Medical Call Mask and Landing displays the status of the car designated for emergency service within the group.

Follow the steps below to view the Emergency Medical Call Mask and Landing:

1. Navigate to **Main Menu | Debug | Car Data**.
2. From the Car Data Overview Status, press the right button.
3. From the Hall Mask Status, press the right button.
4. From the Front Opening Map Status, press the right button.
5. From the Rear Opening Map Status, press the right button.
6. From the Front Security Map Status, press the right button.
7. From the Rear Security Map Status, press the right button.

8. From the Linked Hall Mask Status, press the right button.
9. From the Front Hall Security Map Status, press the right button.
10. From the Rear Hall Security Map Status, press the right button.
11. From the Hall Security Mask Status, press the right button.
12. From the Dispatching Timer Status, press the right button.
13. From the VIP Flag Status, press the right button.
14. From the VIP Mask Status, press the right button.
15. From the Front Car Call Enable Bitmap Status, press the right button.
16. From the Rear Car Call Enable Bitmap Status, press the right button.
17. View the Emergency Medical Call Mask and Landing Status.

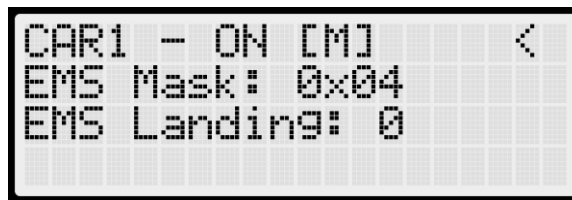

Figure 33: Emergency Medical Call Mask and Landing

- **EMS Mask:** Hall Mask indicating which Hall Risers are interpreted as Emergency Medical Calls by the car.
- **EMS Landing:** Displays the assigned landing for an Emergency Medical Call. A value of “1” represents the lowest landing served by the group; “0” indicates no assignment.

## 5 Hall Network

The Hall Network is a group of Hall boards connected by a CAN bus.

### 5.1 CAN Bus

Each Hall Board communicates over a CAN bus with a Riser Board located in the Machine Room. The figure below illustrates a standard CAN network. For optimal performance, cable stub lengths should be minimized, and only Node 1 and Node 4 on the CAN bus line should be terminated.

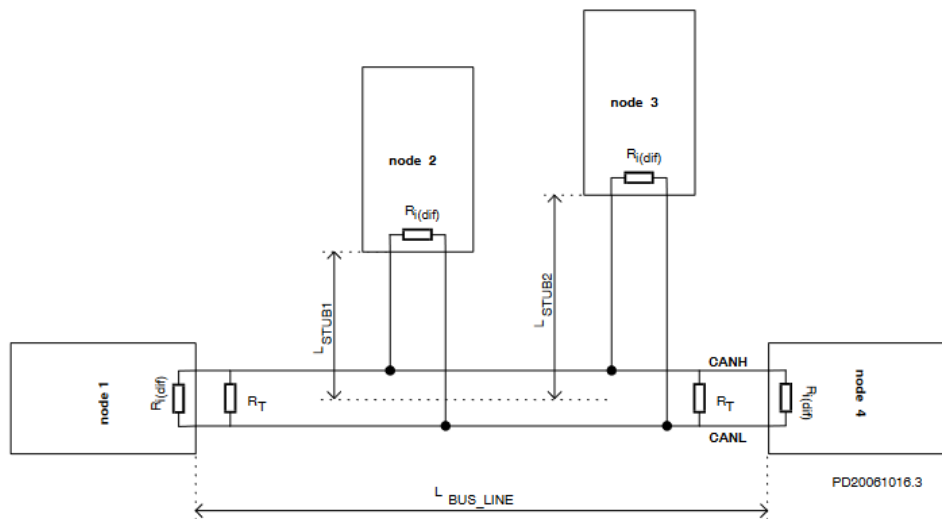
Figure 34: Standard CAN Bus<sup>1</sup>

**Termination:** The first and last boards on each CAN network must be terminated.

- ◆ **Example 1:** A single set of Hall Buttons is wired to Riser Board 1.
  - Terminate CAN2 on the Riser Board and the bottom landing Hall Board.
- ◆ **Example 2:** Two sets of Hall Buttons are both wired to Riser Board 1.
  - Terminate the bottom landing Hall Board in each set.
  - Do not terminate CAN2 on the Riser Board.
  - For tall buildings, the second set of Hall Boards may need to be split off and connected to a second Riser Board. In that case, terminate both networks as described in Example 1.

**NOTE:** Most Hydro:Evolved PCBs use a jumper for CAN bus termination. On Hall Boards, termination is set by switching **DIP 10** or **DIP 12** to **ON**, depending on the Hall Board type.

**Stub Length:** A CAN bus should resemble a long trunk line with only short stub connections, each kept under 1 foot in length.

**Connections:** Use a twisted pair over CAT5 splitters whenever possible. For networks with more than 20 Hall Boards, provide additional power and REF connections to prevent voltage drops.

## 5.2 Hall Board Status

If issues arise due to Hall Calls, begin by checking the Hall Board Status from the UI menu. This display provides key information on each board's communication status, error state, connected Riser board, I/O configuration, and DIP switch addressing.

To verify the Hall Board status, navigate to **Main Menu | Status | Hall Board Status**.

<sup>1</sup> See <https://www.onsemi.com/pub/Collateral/AND8376-D.PDF> for CAN Bus with Unterminated Stubs



Figure 35: Hall Board Status



Figure 36: Uninitialized Hall Board Status

**The Hall Board Status screen displays the following:**

- Indicates it belongs to the first function range of Hall boards.
- Shows connection to Riser board 1 in the machine room.
- Confirms no active errors.
- Both Up and Down buttons are currently being pressed.
- Both Up and Down lamps are currently lit.

**NOTE:** Once communication is established with a Hall board, if communication is later lost, the COM Status will show 0% instead of N/A.

**5.3 Hall Security Mask**

The Hall Security Mask defines which Hall Call Masks require a hall security contact. Each bit in the mask corresponds to a specific Hall Board Function ID. The mask is divided into front and rear sections – HSMF and HSMR – based on the Hall Rear Door Mask (see section 5.10 Hall Rear Door Mask). The Hall Security Mask parameter is **08-0208**. For a full list of related parameters, refer to the **Hydro:Evolved Parameter List**.

Follow the steps below to set Hall Security Mask:

1. Navigate to **Main Menu | Setup | Group Setup | Hall Security Mask**.
2. Turn **ON** the Hall board functions that need to be secured.
3. Scroll right and press **Save**.

**5.4 Hall Security Map**

The Hall Security Map defines which landings require a hall security contact. The configuration from the master group car (the car with the lowest Group Car ID) is used for control. However, all cars should be configured with the same Hall Call Security parameters to ensure continuity if the master group car is taken offline. The front Hall Security Map parameters range from **16-0940** to **16-0945**, and the rear parameters range from **16-1035** to **16-1040**. For a complete list of parameters, refer to the **Hydro:Evolved Parameter List**.

Follow these steps to set the Hall Security Map:

1. Navigate to **Main Menu | Setup | Group Setup | Hall Security Map (Front or Rear)**.
2. Scroll and select the Front or Rear landings that require security access. Setting the landing to ON enables security for that landing.
3. Scroll right and press **Save**.

### 5.5 Hall Security Status

The Hall Security Status screen displays the current status of the Hall Boards involved in Hall Call Security.

Follow these steps to view the Hall Security Status:

1. Navigate to **Main Menu | Status | Hall Security Status**.
2. Scroll up or down to view the floors that are set for Hall Security.

### 5.6 Hall Call Mask

The Hall Call Mask must be configured to enable standard Hall Calls for a car. This setting is located at addresses **08-0209 to 08-0212**. The values for these addresses vary based on the Function IDs of the installed Hall Boards.

For a complete list of parameters, refer to the **Hydro:Evolved Parameter List**.

Follow these steps to set the Hall Call Mask:

1. Navigate to **Main Menu | Setup | Group Setup | Hall Call Mask**.
2. Scroll and select the function to be enabled.
3. Scroll right and press **Save**.

To determine the correct value for the address, refer to the table below and add the corresponding values of each Function ID serviced by the car.

The table below provides the Hall Board 10-DIP Hall Mask Mapping switch settings.

Table 8: Hall Board 10 DIP Hall Mask Mapping Switch Settings

DIP Switch 7-8-9	Function ID	Mask Value (Decimal)
OFF-OFF-OFF	1	1
ON-OFF-OFF	2	2
OFF-ON-OFF	3	4
ON-ON-OFF	4	8
OFF-OFF-ON	5	16
ON-OFF-ON	6	32
OFF-ON-ON	7	64
ON-ON-ON	8	128

The table below provides the Hall Board 12-DIP Hall Mask Mapping switch settings.

Table 9: Hall board 12 DIP Hall Mask Mapping Switch Settings

DIP Switch 8-9-10	Function ID	Mask Value (Decimal)
OFF-OFF-OFF	1	1
ON-OFF-OFF	2	2
OFF-ON-OFF	3	4
ON-ON-OFF	4	8
OFF-OFF-ON	5	16
ON-OFF-ON	6	32
OFF-ON-ON	7	64
ON-ON-ON	8	128

## 5.7 Linked Hall Buttons

To illuminate two sets of Hall buttons simultaneously, the **Paired Hall Mask** parameter must be configured. This parameter must be set on each Group Car. It is located at address **08-0178**, and its value depends on the Function IDs of the paired Hall Boards.

If additional pairings are needed, addresses **08-0179** through **08-0181** are available for use.

For a complete list of parameters, refer to the **Hydro:Evolved Parameter List**.

**Example 1:** Pairing Hall Boards with Function ID 0 (DIP 7, 8, and 9 OFF) and Function ID 2 (DIP 7 ON), set **08-0178** to **x03** (3 in decimal).

**Example 2:** Pairing Hall Boards with Function ID 3 (DIP 8 ON) and Function ID 4 (DIP 7 and 8 ON), set **08-0178** to **x0C** (12 in decimal).

Follow these steps to set the Linked Hall Mask:

1. Navigate to **Main Menu | Setup | Group Setup | Linked Hall Mask**.
2. Scroll and select the Hall boards within the group that are linked.
3. Scroll right and press **Save**.

## 5.8 Hall Medical Mask

The Hall Medical Mask configures Hall Boards to recognize Emergency Medical Service (EMS) calls. These calls direct the nearest car to enter Emergency Medical Service mode.

The procedure below outlines how to configure the Hall Medical Mask.

Consider the following two scenarios:

**Case I:** If the Hall Medical Rear Door Mask is not activated, and a front Hall Call is initiated from a medical floor with both front and rear openings, both doors will open.

**Case II:** If the Hall Medical Rear Door Mask is activated, and a front Hall Call is initiated from a medical floor with both front and rear openings, only the front door will open.

1. Navigate to **Main Menu | Setup | Group Setup | Hall Medical Mask**.

2. Scroll and select which cars are set for emergency service calls.
3. Scroll right and press **Save**.

### 5.9 Hall Medical Rear Door Mask

The Hall Medical Rear Door Mask configures Hall Boards to support Rear Emergency Medical Service calls. These calls place the nearest car into EMS mode of operation.

The following procedure explains how to configure the Hall Medical Rear Door Mask. Consider the two scenarios below:

**Case I:** If the Hall Medical Rear Door Mask is not activated, and a front Hall Call is initiated from a medical floor with both front and rear openings, both the Front and Rear doors will open.

**Case II:** If the Hall Medical Rear Door Mask is activated, and a front Hall Call is initiated from a medical floor with both front and rear openings, only the front door will open.

1. Navigate to **Main Menu | Setup | Group Setup | Hall Medical Rear Door Mask**.
2. Scroll and select which cars are set for Rear emergency service calls.
3. Scroll right and press **Save**.

### 5.10 Hall Rear Door Mask

The Hall Rear Door Mask specifies which Hall Boards are configured to handle Rear door calls. Boards designated for rear door calls will operate in latched mode, allowing the call to remain active until it is properly serviced.

Follow these steps to set the Hall Rear Door Mask:

1. Navigate to **Main Menu | Setup | Group Setup | Hall Rear Door Mask**.
2. Scroll and select the Hall Calls that service landings where only the Rear door opens.
3. Scroll right and press **Save**.

### 5.11 Split Group Masks

When different Hall Masks and EMS Masks are required, the Override Group Hall Mask input must be activated. This causes the cars within the group to split, allowing separate EMS and Hall Masks to be applied.

- The **Override Group Hall Mask (08-0146)** replaces the standard **Hall Call Mask (08-0209)**.
- The **Override Group Medical Mask (08-0273)** replaces the standard **Hall Medical Mask (08-0210)**.

### 5.12 Errors

The following errors may be reported:

- **UNK:** The board is uninitialized.

- **NONE:** The board has no errors.
- **POR:** The board is starting up.
- **WDT:** The board stalled and triggered a reset.
- **BOR:** The board power was insufficient and triggered a reset.
- **COM:** The board is not receiving commands.
- **DIP:** The board has the same address as another board on the network.
- **BUS:** The board is resetting its CAN transceiver.

### 5.13 Compatibility

The Hydro:Evolved Hall Board and the V2 Hall Board are not compatible. Hydro:Evolved Hall Boards are equipped with 10 or 12 DIP switches depending on the configuration, while V2 Hall Boards have 8 DIP switches.

## 6 Serial Hall Lanterns

Serial Hall Lantern boards – interchangeable with Hall Call boards – connect to the CAN network of the MR board. Because these boards share the same hardware and software, this manual collectively refers to them as Hall Boards.

### 6.1 CAN BUS

The Serial Hall Lantern boards follow the same CAN bus guidelines as standard Hall Boards.

- By default, the CAN network is terminated at the MR board.
- Terminate only the lowest landing's Serial Hall Lantern board.
- If a CE Driver board is present on the network, its CAN termination must be disabled.

### 6.2 Hall Lantern Masks

To enable communication with Serial Hall Lantern boards, configure the Hall Lantern Mask for the car:

- **Address:** 08-0213
- **Value:** Determined by adding the values corresponding to each Function ID of the installed Serial Hall Lantern boards.
- Use Table 8 and Table 9 from section **5.6 Hall Call Mask** to find the appropriate Function ID mask values.

#### Rear Hall Lantern Mask:

- **Address:** 32-0036
- Use this setting to configure Serial Hall Lantern boards to serve rear calls.
- Add the mask values of all Function IDs that serve as rear calls, using Table 8 from section **5.6 Hall Call Mask** as a reference.

For a full list of parameters, refer to the **Hydro:Evolved Parameter List**.

### 6.3 Serial Hall Lantern Status

If issues occur with any Serial Hall Lantern board, begin by checking the Hall Lantern Status via the **Status** menu.

The **Status** menu displays:

- Board communication status
- Error states
- I/O activity
- DIP switch address settings

To verify Hall Lantern status, navigate to **Main Menu | Status | Hall Lantern Status**.



Figure 37: Hall Lantern Status



Figure 38: Uninitialized Hall Lantern Status

## 7 Additional Hydro Settings

This section outlines the procedures for configuring additional hydro settings.

### 7.1 Battery Test Time

The Battery Test Time defines the time of day when the controller checks for a battery fault signal. If a fault is detected at this time for three consecutive days, an Emergency Battery Fault is triggered.

Follow these steps to set the Battery Test Time:

1. Navigate to **Main Menu | Setup | Hydro | Battery Test Time**.
2. Enter the time the controller searches for a battery fault.
3. Scroll right and press **Save**.

### 7.2 Jack Resync Time

In Jack Resync operation, required for hydro elevators equipped with dual jacks, the system compensates for drift that occurs over time. As the jacks move out of sync, one may extend higher than the other, causing the car to become uneven or out of level.

The resync operation corrects this condition by evacuating oil from both jack cylinders, returning the plungers to a synchronized position. This operation is generally scheduled as a timed event. The mechanic sets a specific time (e.g., 3:00 AM) for the controller to automatically initiate the resync procedure.

Follow these steps to set the Jack Resync Time:

1. Navigate to **Main Menu | Setup | Hydro | Jack Resync | Jack Resync Time**.
2. Set the jack resync time.
3. Scroll right and press **Save**.

### 7.2.1 Disable NTS Alarm

By default, the NTS alarm is disabled. It is enabled during the NTS acceptance test.

Follow these steps to Disable NTS Alarm:

1. Navigate to **Main Menu | Setup | Hydro | Disable NTS Alarm**.
2. Set the Disable NTS Alarm to **ON**.
3. Scroll right and press **Save**.

## 8 Slowdowns

Several peripherals affect the car's acceleration, deceleration, and speed in both the upward and downward directions. These include oil temperature and viscosity, and the car's weight.

### 8.1 Level Maximum Run Distance

Set the maximum run distance for which the level valve speed run is allowed. Longer runs outside door zones may require a higher-speed valve. If set to zero, even short-distance runs will use the higher-speed valve, increasing the risk of overshooting the destination.

To set the Level Maximum Run Distance:

1. Navigate to **Main Menu | Setup | Hydro | Level Maximum Run Distance**.
2. Set the maximum run distance.
3. Scroll right and press **Save**.

### 8.2 NTS Buffer Distance Up and Down

An NTS alarm may occur in either direction during normal operation. If this happens, increase the NTS buffer distance.

To set the NTS Buffer Distance Up and Down:

1. Navigate to **Main Menu | Setup | Hydro | NTS Buffer Distance Up or NTS Buffer Distance Down**.

2. Set the appropriate buffer distance.
3. Scroll right and press **Save**.

### 8.3 Destination and Relevel Offsets

A delay occurs at the end of a run between cutting the leveling speed valve and the elevator stopping. This may cause the car to overshoot the destination and relevel. To address this, adjust the destination offset to stop the car slightly before the destination.

#### 8.3.1 Destination Offset

The destination offset determines when to cut the leveling valves. If the car levels correctly but overshoots the destination, adjust the offset based on the direction.

To set the Destination Offset:

1. Navigate to **Main Menu | Setup | Hydro | Offset Up or Down**.
2. Determine if the car stops outside the dead zone:
  - If the car is moving up, go to step 3.
  - If the car is moving down, go to step 4.
3. Increase the **Up Offset** by 0.5 inches.
4. Increase the **Down Offset** by 0.5 inches.
5. Scroll right and press **Save**.

#### 8.3.2 Relevel Offset

This defines how far from the destination the leveling valve is cut during releveling.

To set the Relevel Offset:

1. Navigate to **Main Menu | Setup | Hydro | Relevel Offset Up or Down**.
2. Set the offset based on the overshoot distance.
3. Scroll right and press **Save**.

### 8.4 Speed Thresholds

The speed threshold is compared to the current speed to determine the slowdown distance used to reach the destination.

To set the Speed Threshold:

1. Navigate to **Main Menu | Setup | Hydro | Speed Thresholds**.

2. Set the speed threshold.
3. Scroll right and press **Save**.

## 8.5 Slowdown Distance

The slowdown distance is the distance where the car transitions from high to leveling speed. If weights are added to the car, refer to section **8.7.3 Monitoring Adaptive Slowdown™ system (U.S. Patent Pending)**.

To set the Slowdown Distance:

1. Navigate to **Main Menu | Setup | Hydro | Slowdown Distance Up or Down**.
2. Set the slowdown distance.
3. Scroll right and press **Save**.

## 8.6 Hydro Speed Setup

The Hydro Speed Setup uses the slowdown factor of the distance and time relative to the speed to calculate slowdown distances and thresholds for each landing. Longer times produce longer distances.

**Example:** if the factor is 1 second, the slowdown distance will be 2' 1", whereas if the factor is 1.78 seconds, the slowdown distance will be 3' 8". Depending on the high speed and type of valve setup, the factor can be determined. To have a proper slowdown for up or down direction, adjust the up and down time.

1. Navigate to **Main Menu | Setup | Hydro | Hydro Speed Setup | Up and Down Adjustment** (need to set both).
2. Set the time for which the car is expected to transition from high speed to low speed.
3. Navigate back to **Generate Thresholds and Distances** and select **YES**.
  - If overshooting occurs, following instructions under section **8.6.1 Car Overshooting** and repeat steps 1-3.
  - If leveling time is too long or short, follow instructions under section **8.6.2 Adjust Leveling Time** and repeat steps 1-3.

### 8.6.1 Car Overshooting

If the car overshoots, increase the transition time. This causes the car to slow down sooner which increases the slowdown distance.

To resolve car steady state if overshooting occurs:

1. Navigate to **Main Menu | Setup | Hydro | Hydro Speed Setup | Up and Down Adjustment** (need to set both).
2. Adjust the up or down distance by increasing the transition time. This should cause the car to slow down sooner which increases the slowdown distance.
3. Navigate back to **Generate Thresholds and Distances** and select **YES**.

### 8.6.2 Adjust Leveling Time

With weight added to the car, it might take longer than usual (three to five seconds) for the car to level. Decreasing the slowdown distance decreases the time it takes for the car to level.

To resolve car steady state if leveling takes longer:

1. Navigate to **Main Menu | Setup | Hydro | Hydro Speed Setup | Up and Down Adjustment** (need to set both).
2. Adjust the up or down distance by decreasing the transition time. This should cause the car to have a shorter slow down period which decreases the slowdown distance.
3. Navigate back to **Generate Thresholds and Distances** and select **YES**.

### 8.7 Adaptive Slowdown™ system (U.S. Patent Pending)

This feature operates in addition to the Hydro Evolved Setup Slowdown Distance instructions. When active, the Adaptive Slowdown™ system (U.S. Patent Pending) monitors the operation of each run. After each run, the software adjusts a reference slowdown distance variable based on previous runs so that subsequent runs result in leveling times closer to the target leveling time selected. Run-to-run variances in elevator operations will not have a significant effect on the reference slowdown distance.

#### 8.7.1 Procedure

Follow the steps below after successfully setting the adjusted slow down distance:

1. Measure the leveling time from when the car reaches the level speed until the car stops. The measured leveling time will be used as the baseline for the target time used in step 3.
2. Navigate to **Main Menu | Setup | Hydro | Adaptive Slowdown™ System (U.S. Patent Pending) | Leveling Target**.
3. Set the slowdown target time to the time measured in step 1.
4. Scroll right and press **Save**.
5. Navigate to **Main Menu | Setup | Hydro | Adaptive Slowdown™ System (U.S. Patent Pending) | Enable Slowdown**.
6. Set to **ON**.
7. Allow the car to run from floor to floor for two full cycles to adjust the slowdown distance. It is recommended to run the car empty during the first two cycles to allow the car to measure the slowdown distance accurately.

#### 8.7.2 Troubleshoot Adaptive Slowdown™ system (U.S. Patent Pending)

Use the following steps to troubleshoot car behavior under various conditions:

- ◆ **Car is overshooting the landing:** Overshooting may occur if the leveling time is too short to accommodate weight-induced changes in slowdown distance. In this case, the car compensates by increasing the slowdown distance. The Adaptive Slowdown™ system (U.S. Patent Pending) reduces the distance incrementally until an overshoot is detected.

- ➔ Increase the target time in of 0.5-second increments and repeat step 5 of the procedure.
- ◆ **Car is taking too long to arrive to the landing:** The system will decrease the leveling time in 0.1-second increments based on the initial Hydro Speed Setup until the Target Time is achieved. It will continue to fluctuate within a defined range. Reducing the Target Time range decreases this fluctuation.
  - ➔ Decrease the target time in of 0.5-second increments and repeat step 5 of the procedure.
- ◆ **Car is misaligned with the landing:** The car is within the door zone but slightly above or below the landing.
  - ➔ Refer to the floor adjustment procedure to align the car properly.
- ◆ **TSRD fault occurs when approaching the landing:** his fault occurs when the TSRD distance is too large relative to the required slowdown distance.
  - ➔ Navigate to **Main Menu | Setup | Hydro | TSRD Distance**.
  - ➔ Decrease the TSRD Distance and repeat step 5 of the procedure.

### 8.7.3 Monitoring Adaptive Slowdown™ system (U.S. Patent Pending)

Monitor actual average slowdown distances via **Main Menu | Debug | View Debug Data | Index 070 (UP) and Index 071 (DN)**

These indexes update at the end of each run:

- Index 070 shows the Up distance average.
- Index 071 shows the Down distance average.

These values may increase after TSRD or NTS events.

**NOTE:** If distances are not stable, the car may be experiencing NTS alarms at terminal landings. Check leveling time distances. If debug data average distances fall significantly below the leveling time, NTS alarms may be triggered. To correct this, either reduce the leveling time or increase the NTS timeout via **Main Menu | Safety | NTS ODL**.

## 8.8 Slowdown Distance After Adjustments

After initial setup with an empty car, weights must be added to verify leveling under full load.

Use the same slowdown distance and speed settings of an empty car while gradually increasing load until fully loaded.

To verify Slowdown Distance and Speed:

1. Add a 500 lb load to the car.
2. Place single- and multi-floor calls in both directions.
3. Observe for overshooting, releveling, or extended leveling times.

If valves are not regulated, deceleration and leveling behavior may vary. The deceleration rate will increase or the leveling speed will decrease as the weight of the car increases.

### Three Behaviors Can Occur While Adding Weights:

- ◆ **Overshooting:** Increase slowdown distance.
- ◆ **Leveling time too long:** Decrease slowdown distance.
- ◆ **Unregulated valves with longer leveling:** Do not adjust slowdown distance.

**Important:** DO NOT regenerate thresholds and distances after fine-tuning slowdown values. Doing so will override manual adjustments.

To fine-tune Slowdown Distance:

1. Observe the car's maximum speed before slowdown begins.
2. Navigate to **Main Menu | Setup | Hydro | Slowdown Distance UP or DOWN.**
3. Choose the correct speed threshold and corresponding slowdown distance.
4. Adjust accordingly if overshooting or extended leveling occurs.

There are seven speed thresholds and slowdown distances. Select the appropriate one based on actual high speed.

#### 8.8.1 Overshooting

As load increases, car speed and slowdown time may decrease. If overshooting occurs, increase the slowdown distance to allow more time to decelerate. If the valves are regulated, the speed of the car may not change.

#### Adjustment Procedure:

1. Navigate to **Main Menu | Setup | Hydro | Slowdown Distance UP.**
2. Select the correct speed threshold and corresponding slowdown distance.

**Example:** If loaded car speed is 100 fpm, select a threshold for 105 fpm.

3. Increase slowdown distance from, e.g., 2'09" to 3'02".
4. Place an up call and observe. Repeat if necessary.
5. Scroll right and press **Save**.
6. Repeat with added weight until the car is fully loaded.

#### 8.8.2 Extended Leveling Time (Steady State)

When added weight causes longer leveling, decrease slowdown distance to reduce leveling time. Choose the correct speed threshold based on car speed.

#### Adjustment Procedure:

1. Navigate to **Main Menu | Setup | Hydro | Slowdown Distance DOWN**.
2. Choose the appropriate speed threshold and slowdown distance.  
**Example:** If loaded car speed is 100 fpm, use the 105 fpm threshold.
3. Decrease slowdown distance, e.g., from 3'06" to 2'09".
4. Place a down call and observe. Repeat if necessary.
5. Scroll right and press **Save**.
6. Continue loading and verifying until the car is fully loaded.

## 8.9 TSRD Distance

The TSRD is the minimum safe distance from terminal floors at which the car can stop without hitting buffers. If the car travels over 50 FPM within this range, a TSRD fault will trigger an emergency stop.

To set the TSRD Distance:

1. Navigate to **Main Menu | Setup | Hydro | TSRD Distance**.
2. Set the appropriate value based on learned positions.

## 9 Miscellaneous

The controller is bound by the set parameters. The miscellaneous parameters are the general parameters to control other variables within the elevator.

### 9.1 Bypass Term Limit

The Bypass Terminal Limit allows the car to travel beyond the configured terminal limits when operating in Inspection mode.

Follow these steps to bypass the terminal limits:

1. Navigate to **Main Menu | Setup | Miscellaneous | Bypass Term Limits**.
2. Set Bypass Terminal Limits to **On**.
3. Scroll right and press **Save**.

### 9.2 Enable Construction Box

When the Enable Construction Box parameter is set to ON, the CUP and CDN inputs on the MR Board are used to move the car. Ensure that 24 VDC is wired directly to the CEN input. If not, 24 VDC must be jumped to CEN.

Follow these steps to enable the Construction Box:

1. Navigate to **Main Menu | Setup | Miscellaneous | Enable Construction Box**.

2. Set to **On** to enable the construction box.
3. Scroll right and press **Save**.

### 9.3 Maximum Run Time

The maximum run time is the longest duration the car is allowed to travel from one floor to another.

Follow the steps below to set the Maximum Run Time:

1. Navigate to **Main Menu | Setup | Miscellaneous | Maximum Run Time**.
2. Set the maximum time the car runs before a fault is issued.
3. Scroll right and press **Save**.

### 9.4 CT Insp. Req. IC

An IC Inspection can be performed prior to CT Inspection if required.

Follow these steps to enable the CT Inspection:

1. Navigate to **Main Menu | Setup | Miscellaneous | CT Insp. Req. IC**.
2. Scroll and select **On** to enable CT Inspection.
3. Scroll right and press **Save**.

### 9.5 Dis. IdleTrvArrow

When set to ON, CE travel arrows display the car's current direction of motion. When set to OFF, the arrows indicate both the car's motion direction and its arrival direction after completing a run.

Follow these steps to disable the Travel Arrow:

1. Navigate to **Main Menu | Setup | Miscellaneous | Disable IdleTrvArrow**.
2. Scroll and select **On** to disable the direction arrow.
3. Scroll right and press **Save**.

### 9.6 Enable Latches Car Calls

When set to ON, the car call button latches a car call when pressed.

Follow these steps to enable Latching a Car Call:

1. Navigate to **Main Menu | Setup | Miscellaneous | Enable Latches CC**.
2. Scroll and select **On** to enable car call latching.

3. Scroll right and press **Save**.

## 9.7 En. 3 Digit PI

The 3-Digit PI setting enables floor labels to display up to three characters, replacing the default two-character format.

Follow these steps to enable the 3 Digit PI:

1. Navigate to **Main Menu | Setup | Miscellaneous | Enable 3 Digit PI**.
2. Scroll and select **On** to enable 3-digit PI.
3. Scroll right and press **Save**.

## 9.8 Default

The default settings are the controller's original settings prior to any modifications.

### 9.8.1 Default Floors

This setting restores the original Learned Floors when selected.

Follow the steps below to Default Floors:

1. Navigate to **Main Menu | Setup | Miscellaneous | Default | Default Floors**.
2. Select **Yes** to default floors.
  - To cancel without restoring, select **No**.

Once the system completes the process, the **DEFAULTING PARAMS** menu will display "**Parameters Defaulted**".

### 9.8.2 Default Run Timers

This setting restores the original Run Timers when selected.

Follow the steps below to Default Run Timers:

1. Navigate to **Main Menu | Setup | Miscellaneous | Default | Default Run Timers**.
2. Select **Yes** to default run timers.
  - To cancel without restoring, select **No**.

Once the system completes the process, the **DEFAULTING PARAMS** menu will display "**Parameters Defaulted**".

### 9.8.3 Default I/O

This setting restores the original Inputs and Outputs (I/O) when selected.

Follow the steps below to Default I/O:

1. Navigate to **Main Menu | Setup | Miscellaneous | Default | Default I/O**.
2. Select **Yes** to default I/O.
  - To cancel without restoring, select **No**.

Once the system completes the process, the **DEFAULTING PARAMS** menu will display “**Parameters Defaulted**”.

#### 9.8.4 Default Other

This setting restores other parameters within the system back to the original factory settings.

Follow the steps below to Default Other Parameters:

1. Navigate to **Main Menu | Setup | Miscellaneous | Default | Default Other**.
2. Select **Yes** to default other parameters.
  - To cancel without restoring, select **No**.

Once the system completes the process, the **DEFAULTING PARAMS** menu will display “**Parameters Defaulted**”.

#### 9.8.5 Default Factory

This setting restores the original factory settings when selected.

Follow the steps below to Default Factory:

1. Navigate to **Main Menu | Setup | Miscellaneous | Default | Default Factory**.
2. Select **Yes** to default factory.
  - To cancel without restoring, select **No**.

Once the system completes the process, the **DEFAULTING PARAMS** menu will display “**Parameters Defaulted**”.

## 10 Timers

Timers are utilized for energy conservation.

### 10.1 Fan & Light Timer

The Fan and Light Timer sets the duration the fan and lights remain on.

Follow these steps to set the Fan & Light Timer:

1. Navigate to **Main Menu | Setup | Miscellaneous | Fan & Light Timer**.
2. Set the fan and light timer.
3. Scroll right and press **Save**.

## 10.2 External Fan Timer

The External Fan Timer sets the duration the fan and lights remain on while the car is idle.

Follow these steps to set the External Fan Timer:

1. Navigate to **Main Menu | Setup | Miscellaneous | External Fan Timer**.
2. Set the external fan timer.
3. Scroll right and press **Save**.

## 10.3 Arrival Update Time

The Arrival Update Time sets the time interval to update lantern outputs before floor arrival.

Follow these steps to set the Arrival Update Time:

1. Navigate to **Main Menu | Setup | Miscellaneous | Arrival Update Time**.
2. Set the time to update lantern outputs.
3. Scroll right and press **Save**.

# 11 Safety

Safety measures are taken to prevent personal injury and to protect the equipment.

## 11.1 Speed Deviation

Speed Deviation is used to detect cases where the car is commanded to move, but no movement is detected within a configured duration.

### 11.1.1 Timeout

A designated timeout monitors Speed Deviation. If the car is commanded to move but movement is not detected within this predefined period, a fault will be triggered.

Follow these steps to configure the Speed Deviation Timeout:

1. Navigate to **Main Menu | Setup | Safety | Speed Deviation | Timeout**.
2. Set the timeout threshold.
3. Scroll right and press **Save**.

## 11.2 Lock Clip

Lock Clip Time is the duration during which the controller ignores an open hall lock condition. This helps prevent intermittent interlock faults.

Follow these steps to configure the Lock Clip Time:

1. Navigate to **Main Menu | Setup | Safety | Lock Clip**.
2. Set the desired time value.
3. Scroll right and press **Save**.

### 11.3 General ODL

The General Overspeed Debounce Limit (ODL) defines the distance for miscellaneous limits.

Follow these steps to configure the General ODL:

1. Navigate to **Main Menu | Setup | Safety | General ODL**.
2. Enter the general debounce limit.
3. Scroll right and press **Save**.

### 11.4 NTS ODL

The NTS ODL reduces the sensitivity of the NTS trip points. Increase this value by 3–5 units to help reduce nuisance tripping if the elevator is tracking is off at the terminal floors.

Follow these steps to configure the NTS ODL:

1. Navigate to **Main Menu | Setup | Safety | NTS ODL**.
2. Enter the NTS debounce limit.
3. Scroll right and press **Save**.

### 11.5 TSRD ODL

The TSRD ODL defines the distance to the bottom of the top door zone magnet. If the car crosses this point at more than 50 FPM, power to the valves and pump motor is cut to prevent the car from striking the stop ring at full speed.

Follow these steps to configure the TSRD ODL:

1. Navigate to **Main Menu | Setup | Safety | TSRD ODL**.
2. Enter the TSRD debounce limit.
3. Scroll right and press **Save**.

## 12 Status

The status of each functionality can be viewed to determine which functions are active.

### 12.1 Input Status

The Input Status displays the status for the inputs configured on the MR board.

Follow these steps to view the status of the inputs:

1. Navigate to **Main Menu | Status | Inputs**.
2. Scroll and select the type of input.
3. View the status of the input configured.

### 12.2 Output Status

The Output Status displays the status for the outputs configured on the MR board.

Follow these steps to view the status of the outputs:

1. Navigate to **Main Menu | Status | Outputs**.
2. Scroll and select the type of output.
3. View the status of the output configured.

### 12.3 Valves 1, 2, 3 & 4 Statuses

The statuses of Valves 1, 2, 3, and 4 display valve activity and any associated errors. If a valve is not connected to the controller, the **State** and **Error** fields will display “**UNKNOWN**”. If a configuration error is detected, an “**Invalid Config**” message will appear.

Follow these steps to view the status of Valves 1, 2, 3 & 4:

1. Navigate to **Main Menu | Status | Valve 1 Status** (or select Valve 2, 3, or 4 as needed).
2. View the status of the valve.

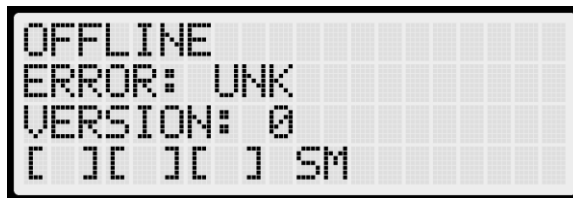

Figure 39: Valve Status Menu – Part 1 of 3



Figure 40: Valve Status Menu – Part 2 of 3



Figure 41: Valve Status Menu – Part 3 of 3

The **Valve Status** menu displays the following information:

- **Valve Activity:** Indicates whether the valve is online or offline.
- **Error:** Displays an error code if a fault is present.
- **Version:** Shows the firmware or software version.
- **SM through DL:** Displays the command signals from the controller, inputs to the Valve board, and outputs from the Valve board.
- **DIP 1:** Shows the command, input, and output status of the primary and secondary Valve boards.
- **DIP 2:** Indicates the operational status of the secondary Valve board. When DIP 2 is ON, testing of the secondary Valve board is paused.

### 12.4 Soft Starter and Soft Starter 2 Status

The Soft Starter Status displays the status of the primary and, if configured, secondary soft starter

Follow these steps to view the Soft Starter Status:

1. Navigate to **Main Menu | Status | Soft Starter Status** or **Soft Starter 2 Status**.
2. View the status of the soft starter.

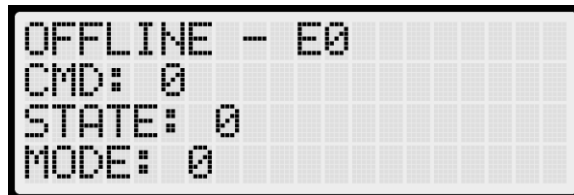

Figure 42: Soft Starter Status Menu – Part 1 of 3

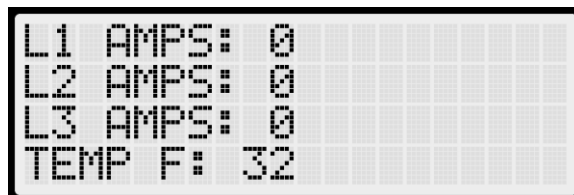

Figure 43: Soft Starter Status Menu – Part 2 of 3

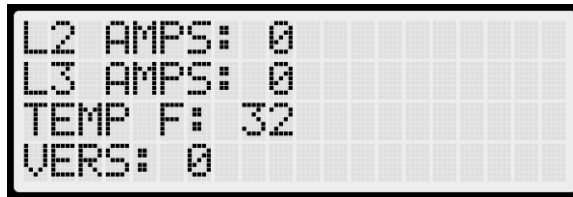

Figure 44: Soft Starter Status Menu – Part 3 of 3

The **Soft Starter** and **Soft Starter 2 Status** menus display the following information:

- **Soft Starter Activity:** Indicates whether the soft starter is online or offline.
- **CMD:** Displays an error code if a fault is present.
- **STATE:** Shows the current state of the soft starter.
- **MODE:** Displays the operating mode of the soft starter.
- **L1 - L3:** Displays the current (in amps) through each phase.
- **Temperature:** Shows the soft starter temperature in °F.
- **Version:** Indicates the currently installed software version.

### 12.5 Expansion Status

The Expansion Status displays the Input/Output of an expansion board in service. The “IN:” and “OUT:” display the active inputs and outputs on the board, respectively.

Follow these steps to view the Expansion Status:

1. Navigate to **Main Menu | Status | Expansion Status**.
2. Scroll and select the expansion board group.
  - Expansion boards are set in groups of 8.
3. View the status of the expansion board.

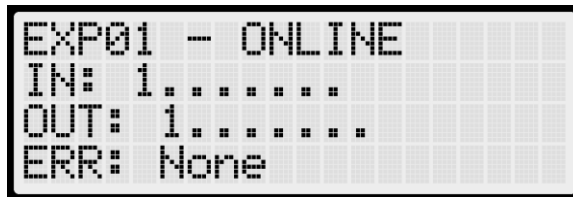

Figure 45: Active Expansion Board Status

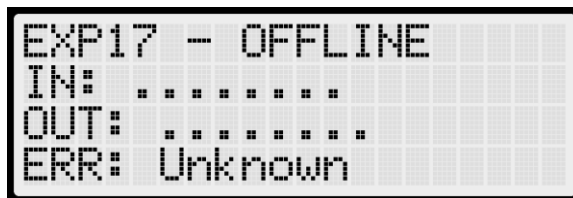

Figure 46: Inactive Expansion Board Status

The **Expansion Board Status** menu displays the following information:

- **Expansion Board Activity:** Displays the connection status of the board.
- **In:** Displays active inputs.
- **Out:** Displays active outputs.
- **Error:** Displays an error if a red LED is illuminated on the Expansion Board.

## 12.6 Riser Board Status

The Riser Board Status displays the activity of the hall network and indicates any errors present.

Follow these steps to view the Riser Board Status:

1. Navigate to **Main Menu | Status | Riser Board Status**.
2. View the Riser board status.

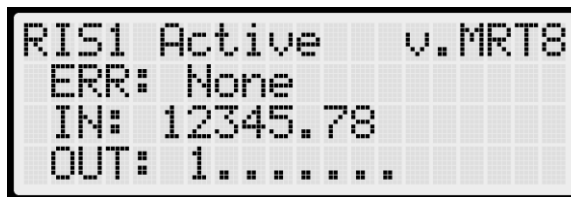

```

RIS1 Active v.MRT8
ERR: None
IN: 12345.78
OUT: 1.....

```

Figure 47: Active Riser Board Status

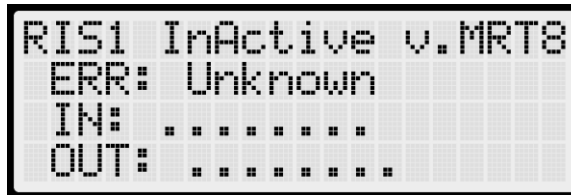

```

RIS1 InActive v.MRT8
ERR: Unknown
IN: .....
OUT: .....

```

Figure 48: Inactive Riser Board Status

The **Riser Board Status** menu displays the following information:

- **Riser Board Activity and Version:** Shows the software version in the top-right corner and indicates the board's activity status. If the Riser board is online, it is marked as **Active**; if offline, it is marked as **Inactive**.
- **Error:** Displays an error if a red LED is illuminated on the Riser board.
- **In:** Displays the active inputs.
- **Out:** Displays the active outputs.

## 12.7 CPLD

The CPLD Status displays the current CPLD software version, any active faults, command signals, and the type of input detected during preflight operation.

Follow these steps to view the MR CPLD Status:

1. Navigate to **Main Menu | Status | CPLD Status**.
2. Scroll and select **MR, CT, or COP CPLD**.
3. View the CPLD status.

- Scroll down to see additional information.

```
MR CPLD
VERSION: MR 3.7
FLT: 00 - NONE
PF STAT: INACTIVE
```

Figure 49: MR CPLD Menu

```
PF CMD: INACTIVE
PFE: 00
INPUTS:
RELAY C SFP [S][M]
```

Figure 50: MR CPLD Menu Continued

```
CT CPLD
VERSION: CT 3.7
FLT: 00 - NONE
PF STAT: INACTIVE
```

Figure 51: CT CPLD Menu

```
PM CMD: INACTIVE
PFE: 00
INPUTS:
CT SW [S][M]
```

Figure 52: CT CPLD Menu Continued

```
COP CPLD
VERSION: COP 3.7
FLT: 00 - NONE
PF STAT: INACTIVE
```

Figure 53: COP CPLD Menu

```
PF CMD: INACTIVE
PFE: 00
INPUTS:
HA INSP [ ][ ]
```

Figure 54: COP CPLD Menu Continued

The input status as detected by the CPLD (Safety Processor) is indicated by an “**S**” in the first bracket when the input is active. The status as detected by the MR, CT, or COP boards is indicated by an “**M**” in the second bracket when the input is active.

- **S:** Safety (CPLD)
- **M:** MCU (MR / COP / CT)

The table below lists the CPLD menu description.

Table 10: CPLD Menu Description

CPLD Menu	Description
<b>CPLD</b>	Displays the type of CPLD being viewed.
<b>VERSION</b>	Displays the CPLD version software.
<b>PFE</b>	Displays the preflight failure number of the CPLD.
<b>FLT</b>	Displays a fault code for an existing fault. If there is no fault, the status is shown as None.
<b>PF STAT</b>	Displays a check performed at the end of runs where safety critical inputs are toggled to confirm hardware functionality. Check if it passed or failed.
<b>PF CMD</b>	Displays the EB relay commands to the MR board as part of the preflight process. This field is not used by the CT and COP boards.
<b>INPUTS</b>	Status of signals read by both the CPLD and the MR, CT, or COP board.

The table below lists the CPLD Preflight status.

Table 11: CPLD Preflight Status

Number	Name	Description
<b>0</b>	INACTIVE	Preflight not in progress.
<b>1</b>	ACTIVE	Preflight check is in progress.
<b>2</b>	PASS	Preflight has completed and detected no errors.
<b>3</b>	FAIL	Preflight has completed and detected errors.

The table below lists CPLD Preflight command.

Table 12: CPLD Preflight Command

Number	Name	Description
<b>0</b>	INACTIVE	No commands issued the EB relays.
<b>4</b>	PICK BYP	CPLD issuing override command to pick the EB4 relay.
<b>5</b>	DROP RG	CPLD issuing override command to drop the EB2 relay.
<b>6</b>	PICK RG	CPLD issuing override command to pick the EB2 relay.
<b>7</b>	DROP BYP	CPLD issuing override command to drop the EB4 relay.

The table below lists CPLD inputs.

Table 13: CPLD Inputs

Name	Description
<b>MR Board</b>	
<b>RELAY C SFP</b>	Control signal to the SFP relay
<b>RELAY M SFP</b>	Status signal of the SFP relay

RELAY C SFM	Control signal to the SFM relay
RELAY M SFM	Status signal of the SFM relay
RELAY C EB1	Control signal of the EB1 relay
RELAY M EB1	Status signal of the EB1 relay
RELAY C EB2	Control signal of the EB2 relay
RELAY M EB2	Status signal of the EB2 relay
RELAY C EB3	Control signal of the EB3 relay
RELAY M EB3	Status signal of the EB3 relay
RELAY C EB4	Control signal of the EB4 relay
RELAY M EB4	Status signal of the EB4 relay
PIT INSP	Status of the Pit Inspection input
LND INSP	Status of the Landing Inspection input
MR INSP	Status of the MR Inspection input
ATU	Status of the Access Top Up input
ATD	Status of the Access Top Down input
ABU	Status of the Access Bottom Up input
ABD	Status of the Access Bottom Down input
MM	Status of the Mechanics Mode input
BYP H	Status of the Bypass Hoistway Door switch
BYP C	Status of the Bypass Car Door switch
LRT	Status of the Rear Top Lock input
LRM	Status of the Rear Middle Lock input
LRB	Status of the Rear Bottom Lock input
LFT	Status of the Front Top Lock input
LFM	Status of the Front Middle Lock input
LFB	Status of the Front Bottom Lock input
120VAC	Status of the 120 VAC Source input
GOV	Status of the Governor input
PIT	Status of the Pit input
BUF	Status of the Buffer input
TFL	Status of the Top Final Limit input
BFL	Status of the Bottom Final Limit input
SFH	Status of the SFH Safety input
SFM	Status of the SFM Safety input
DIP 1B-8B	Status of DIP 1-8 switches
NTS	Status of the MR board NTS output
<b>CT Board</b>	
CT SW	Status of the CT switch
ESC HATCH	Status of the CT Escape Hatch input
CAR SAFE	Status of the CT Car Safeties input
CT INSP	Status of the CT Inspection input
GSWF	Status of the Front Gate switch input
GSWR	Status of the Rear Gate switch input
DZF	Status of the Front Door Zone input
DZR	Status of the Rear Door Zone input
DIP 1B-8B	Status of DIP 1-8 switches
<b>COP Board</b>	
HA INSP	Status of the Hoistway Access Inspection input
IC ST	Status of the IC Stop switch input

<b>FSS</b>	Status of the Fire Stop switch input
<b>IC INSP</b>	Status of the IC Inspection input
<b>DIP 1B-8B</b>	Status of DIP 1-8 switches

## 12.8 E-Power Status

The E-Power Status indicates whether the car is operating on Emergency Power.

Follow the steps below to view which car is operating on Emergency Power:

1. Navigate to **Main Menu | Status | E-Power Status**.
2. View the E-Power status.



Figure 55: E-POWER COMMAND Menu

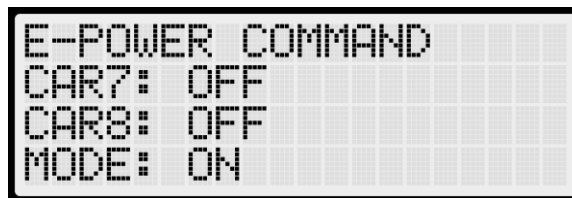

Figure 56: E-POWER COMMAND Menu Continued

The **E-Power Command** menu displays the Emergency Power status for each car in the group, along with the current mode of operation.

The following statuses may appear under each car within the **E-Power Command** menu:

- **Off:** Emergency power is not active.
- **Recall:** A brief command issued to determine the car's current operating mode. It prevents car movement and is used during E-Power Out-of-Service (OOS) operations to gather status.
- **Recall:** The car is commanded to return to its recall floor and remain there with the doors open.
- **Auto:** The car is selected to operate normally.
- **OOS:** The car is commanded to stop immediately if in motion and remain faulted until further commands are issued. This is triggered when a car is awaiting recall, has failed to recall, or if the Up to Speed input is missing.
- **Pretransfer:** The car is commanded to decelerate and stop at the nearest landing, remaining there with doors open until further instructions. This occurs when the **Pretransfer** input is active.

The group-level modes appear in the lower section of the **E-Power Command** menu:

- **Off:** The car group is not operating on emergency power.
- **On:** Group cars are being held out of service, awaiting signals to begin recall.
- **Recall:** Group cars are currently being recalled.

- **Run Car:** Group cars are being selected to run.
- **Pretransfer:** The group is in a pretransfer state due to an active Pretransfer input. This is typically used to stop cars before transitioning from generator power back to main line power.

## 12.9 EMS Status

The Emergency Medical Services Status displays the communication status of the hall board when a car is designated for EMS operation.

Follow the steps below to view the EMS Status:

1. Navigate to **Main Menu | Status | EMS Status**.
2. Scroll and view the status of the EMS Hall Calls assigned to the cars.



Figure 57: EMS STATUS Menu – Car 1 Assigned

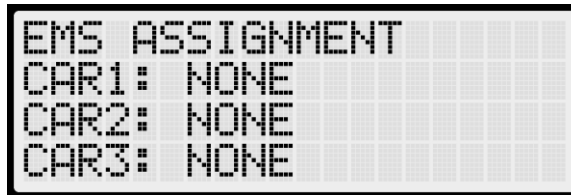

Figure 58: EMS STATUS Menu – No Cars Assigned

- An EMS Hall Call is assigned to the nearest car configured to take these calls.
- If a car is not assigned to EMS operation, the communication status will display “**NONE**”.

## 12.10 Hall Call Status

The Hall Call Status displays the direction of the car when a Hall Call is placed.

Follow these steps to view the Hall Call Status:

1. Navigate to **Main Menu | Status | Hall Call Status**.
2. Scroll and select **Up** or **Down Calls**.
3. View the Hall Calls with the car traveling either up or down.

## 12.11 Virtual Inputs

Virtual Inputs display the status of inputs virtually, rather than through the main screens on the MR, CT, or COP boards.

### 12.11.1 Remote Commands

Remote Commands are instructions and associated parameters sent remotely to the controller. This section displays the status of those commands as received via remote access.

#### 12.11.1.1 Car Call Security

Car Call Security displays the status of the Car Call Security Map set through remote monitoring. Each bit in the hexadecimal value corresponds to a group of four floors.

- ◆ Example:
  - If security access is set for Floors 1 and 4, the display shows: **00000009**
  - If only Floor 1 is set, the display shows: **00000001**
  - If no floors are secured, the display shows: **00000000**

Follow these steps to view the Car Call Security Status for Front or Rear:

1. Navigate to **Main Menu | Status | Virtual Inputs | Car Call Security**.
2. Select either the **Front** or **Rear** Car Calls.
3. View the status of Front or Rear Car Calls that require security access.



Figure 59: Secure Car Front Menu

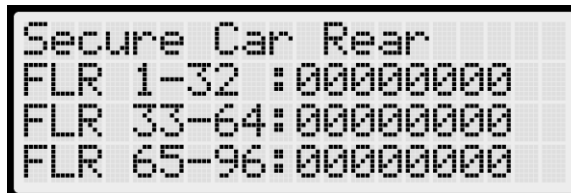

Figure 60: Secure Car Rear Menu

#### 12.11.1.2 Hall Call Security

Hall Call Security displays the hall security mask set through remote monitoring. Each bit in the hexadecimal value corresponds to a group of four floors.

- ◆ Example:
  - If security access is set for Floors 1 and 4, the display shows: **00000009**
  - If only Floor 1 is set, the display shows: **00000001**
  - If no floors are secured, the display shows: **00000000**

Follow these steps to view the Hall Call Security Status for Front or Rear:

1. Navigate to **Main Menu | Status | Virtual Inputs | Hall Call Security**.
2. Select either the **Front** or **Rear** Hall Calls.
3. View the status of Front or Rear Hall Calls that require security access.



Figure 61: Secure Front Hall Call Menu



Figure 62: Secure Rear Hall Call Menu

### 12.11.1.3 Virtual Input

The Virtual Input displays the status of inputs set through the remote monitoring system.

Follow the steps below to view the status of the Virtual Inputs:

1. Navigate to **Main Menu | Status | Virtual Inputs | Virtual Inputs**.
2. View the status of the Virtual Inputs that are active.

### 12.11.1.4 Recall Input

The Recall Input displays the floor to which a car is being recalled, along with the door side (front or rear) that will open upon arrival. This status is shown when a recall is triggered through the remote monitoring system.

Follow these steps to view the status of the Recall Floor and Door:

1. Navigate to **Main Menu | Status | Virtual Inputs | Recall Input**.
2. View the recall floor and corresponding door.

### 12.11.1.5 Door Command Landing

The door command landing displays the status of the doors that have been set to land at a designated floor.

Follow these steps view the status of a door set to land at a designated floor:

1. Navigate to **Main Menu | Status | Virtual Inputs | Door Command Landing**.

2. From the Door Command Landing menu, view the designated landing of the car.

### 12.12 DIP Status

The DIP Status displays the DIP Switches located on the MR, CT, or COP board that are in the ON position.

Follow these steps to view which DIP Switches are ON:

1. Navigate to **Main Menu | Status | DIP Status**.
2. Select **MR, CT, or COP DIP**.
3. View the DIP Switches that are ON for the MR, CT, or COP Board.

### 12.13 Door Status

The Door Status displays the input status of a Front or Rear door.

Follow these steps to view the status of the doors:

1. Navigate to **Main Menu | Status | Door Status (Front or Rear)**
2. View the input status of the door.

## 13 Group Setup

Group Setup defines the operating rules for a set of cars within a group. Each group can include up to eight cars.

### 13.1 Group Car Index

The Group Car Index identifies each car's unique ID within the group.

Follow these steps to set the Group Car Index:

1. Navigate to **Main Menu | Setup | Group Setup | Group Car Index**.
2. Set the car ID.
3. Scroll right and press **Save**.

### 13.2 Group Landing Offset

The Group Landing Offset defines the number of floors below a car's lowest served floor that are handled by other groups. This ensures consistent call alignment across multiple groups by mapping calls to the same physical landing. Proper configuration of this offset is essential for accurate group dispatching.

Follow the steps below to set the Group Landing Offset:

1. Navigate to **Main Menu | Setup | Group Setup | Group Landing Offset**.
2. Set the number of floors below the group's lowest served floor that are serviced by another group.

3. Scroll right and press **Save**.

### 13.3 Dispatch Timeout

The Dispatch Timeout defines the maximum time a car has to respond to a Hall Call. If this time expires without the call being answered, the car is removed from the group, and the call is reassigned to another car.

Follow these steps to set the Dispatch Timeout:

1. Navigate to **Main Menu | Setup | Group Setup | Dispatch Timeout**.
2. Set the Dispatch Timeout.
  - A setting of 0 disables this feature.
3. Scroll right and press **Save**.

### 13.4 Dispatch Offline Timeout

The Dispatch Offline Timeout sets the duration a car remains out of the group after failing to respond to a Hall Call.

Follow these steps to set the Dispatch Offline Timeout:

1. Navigate to **Main Menu | Setup | Group Setup | Dispatch Offline Timeout**.
2. Set the Dispatch OfflineTimeout.
  - A setting of 0 disables this feature.
3. Scroll right and press **Save**.

## 14 PI Labels

The PI Labels allows assigning a two-digit alphanumeric identifier to any landing. To enable three-digit alphanumeric identifiers, refer to section **9.7 En. 3 Digit PI**.

Follow these steps to set the PI Labels:

1. Navigate to **Main Menu | Setup | PI Labels**.
2. Scroll and select the floor indicator label.
3. Scroll right and press **Save**.

## 15 Real-Time Clock

The Real-Time Clock keeps track of the current time and date. Only the **Master Car** has the option to change the Real-Time Clock. All other cars will indicate to go to the **Master Car** to set the time.

Follow these steps to set the date and time:

1. Navigate to **Main Menu | Setup | Real-Time Clock**.

2. Set the date and time.
3. Scroll right and press **Save**.

## 15.1 Clock Status

The Clock Status displays the current time and date in real-time.

Follow these steps to view the real-time and date:

1. Navigate to **Main Menu | Status | Clock**.
2. View the current time and date.

## 16 Debug

The Debug menu provides access to various system status indicators used for diagnostics.

### 16.1 View Debug

The View Debug Data menu displays key debugging information from the main system processors – MR, CT, and COP boards – and can be accessed from each board’s user interface.

The **View Debug Data** screen shows:

- The number of bus errors detected since system startup.
- An approximate percentage of bus throughput currently in use.

This information helps diagnose communication issues related to transmission errors or excessive bus traffic.

Follow these steps to view the Debug Data:

1. Navigate to **Main Menu | Debug | View Debug Data**.
2. Scroll and select the Debug Data of the system to be viewed.

The table below lists the data index for MR, CT, and COP board communication.

Table 14: Data Index for MR, CT, and COP Board Communication

Data Index	Name	Description
1	MR CAN 1	MR board CAN1, Car Network (CN1+/-).
2	NA	NA
3	MR CAN 3	MR board CAN3, Aux Network (AN+/-).
4	MR CAN 4	MR board CAN 4, Group Network (GN+/-).
5	MR A NET	MR board A processor RS232 Network. Shows errors in packets received by the A processor, sent by the B processor.
6	MR B NET	MR board B processor RS232 Network. Shows errors in packets received by the B processor, sent by the A processor.
7	NA	NA
8	CT CAN 1	CT board CAN1, Car Network (CN1+/-).

9	CT CAN 2	CT board CAN2, CEDES camera channel 2.
10	CT CAN 3	CT board CAN3, Aux Network (C3H/L).
11	CT CAN 4	CT board CAN4, CEDES camera channel 1.
12	CT A NET	CT board A processor RS232 Network. Shows errors in packets received by the A processor, sent by the B processor.
13	CT B NET	CT board B processor RS232 Network. Shows errors in packets received by the B processor, sent by the A processor.
14	CT RS485	CT board RS485 network.
15	COP CAN 1	COP board CAN1, Car Network (CN1+/-).
16	COP CAN 2	COP board CAN2, CEDES camera #2 channel 2.
17	COP CAN 3	COP board CAN3, Aux Network (C3H/L).
18	COP CAN 4	COP board CAN4, CEDES camera #2 channel 1.
19	COP A NET	COP board A processor RS232 Network. Shows errors in packets received by the A processor, sent by the B processor.
20	COP B NET	COP board B processor RS232 Network. Shows errors in packets received by the B processor, sent by the A processor.
21	COP RS485	COP board RS485 Network.
22	Run Signal	Displays car run signals as a string of binary digits.
23	Last Stop Pos	Displays the position the car stopped at last run. Only records for normal run stops.
24	MRA Vers.	Displays the third segment of the processor A software version number on the MR board up to 4 characters.
25	MRB Vers.	Displays the third segment of the processor B software version number on the MR board up to 4 characters.
26	CTA Vers.	Displays the third segment of the processor A software version number on the CT board up to 4 characters.
27	CTB Vers.	Displays the third segment of the processor B software version number the CT board up to 4 characters.
28	COPA Vers.	Displays the third segment of the processor A software version number on the COP board. Up to 4 characters.
29	COPB Vers.	Displays the third segment of the processor B software version number on the COP board. Up to 4 characters.
30	Dir. Change Count	Displays the number of times the car has changed direction of movement since controller startup.
31	RIS1 CAN1	Displays the error count seen on Riser 1's CAN1 network.
32	RIS2 CAN1	Displays the error count seen on Riser 2's CAN1 network.
33	RIS3 CAN1	Displays the error count seen on Riser 3's CAN1 network.
34	RIS4 CAN1	Displays the error count seen on Riser 4's CAN1 network.
35	RIS1 CAN2	Displays the error count seen on Riser 1's CAN2 network.
36	RIS2 CAN2	Displays the error count seen on Riser 2's CAN2 network.
37	RIS3 CAN2	Displays the error count seen on Riser 3's CAN2 network.
38	RIS4 CAN2	Displays the error count seen on Riser 4's CAN2 network.
39	DEST CURRENT	Displays information on the current and next destination in the currently serviced direction as seen by MRA.
40	DEST NEXT	Displays information on the next proposed destination in the direction opposite the currently serviced direction as seen by MRA in addition to destination door zone.
41	IDLE TIME	Displays the different idle timers used by the system.
42	NA	NA
43	DOOR DATA F	Displays front door state machine and timer data.

44	DOOR DATA R	Displays rear door state machine and timer data.
45	N/A	Reserved for viewing data via the STATUS   CPLD STATUS screen.
46	N/A	Reserved for viewing data via the STATUS   CPLD STATUS screen.
47	N/A	Reserved for viewing data via the STATUS   CPLD STATUS screen.

## 16.2 Enter Car Calls

Enter Car Calls allows Car Calls to be entered directly from the MR, CT, or COP board. The front or rear door will open – if available – based on the selected floor and door side.

Entering car calls from this menu bypasses all forms of security.

Follow the steps below to enter a Car Call:

1. Navigate to **Main Menu | Debug | Enter Car Calls**.
2. Scroll and select **Front** or **Rear**.
3. Enter a Car Call.

## 16.3 Enter Hall Calls

Enter Hall Calls allows Hall Calls to the group to be entered directly from the MR board.

Follow the steps below to enter a Hall Call:

1. Navigate to **Main Menu | Debug | Enter Hall Calls**.
2. Enter a Hall Call.



Figure 63: Hall Call Menu

The **Hall Call** menu provides the following options:

- **Landing:** Select the desired landing (this is floor-based, not PI Label-based; e.g., 1 = first floor, 2 = second floor, etc.).
- **Dir:** Specifies the direction of the hall call – **DN** for Down or **UP** for Up.
- **Mask Value:** Sets the function mask value. By default, most configurations use a mask value of **1** for front hall calls. To initiate a front hall call, set the mask value to **1**. Once **Landing**, **Dir**, and **Mask Value** are set, press the **middle/enter** button to send the information.
- **Latched:** Displays the mask value that has been accepted into the dispatching logic.

## 16.4 Enter Door Command

The Enter Door Command allows Door Open, Door Close, or Nudge commands to be issued from the MR, CT, or COP boards – provided the car is idle, unfaulted, and in a safe state.

Follow these steps to issue a Door Command:

1. Navigate to **Main Menu | Debug | Enter Door Command**.
2. Select the desired action: **Close, Open, or Nudge**.

If rear doors are configured, the display shows options for both Front and Rear doors. If only front doors are available, the door type selection is omitted.

### 16.5 View Network Packet

The View Network Packet option displays raw data and receives counts for packets transmitted between the MR, CT, and COP boards.

Follow these steps to view the Network Packet:

1. Navigate to **Main Menu | Debug | View Network Packet**.
2. View the Network Packet.

### 16.6 View Group Packet

The View Group Packet options displays raw data and receives counts for packets transmitted between group cars via the GN ± network.

Follow these steps to view the Group Packets:

1. Navigate to **Main Menu | Debug | View Group Packet**.
2. View the Group Packet.

### 16.7 Acceptance Test

The Acceptance Test menu is used to perform verification testing to confirm that the system meets required specifications and functions as intended. Refer to the **C4-H Testing Procedures** for more information.

Follow these steps to perform an Acceptance Test:

1. Navigate to **Main Menu | Debug | Acceptance Test**.
2. Select the test to be performed.

### 16.8 Emergency Bitmap

The Emergency Bitmap displays the type of emergency.

Follow these steps to view the Emergency Status:

1. Navigate to **Main Menu | Debug | EmergencyBitmap**.
2. View the type of emergency indicated by an **X** next to its name.

## 16.9 Module Statuses

The Module Status displays the current status of various system functions.

### 16.9.1 Motion Status

The Motion Status displays the current motion of the car.

### 16.9.2 Pattern Data

Pattern Data is the information used to determine traffic.

### 16.9.3 Auto Status

The Auto Status displays the status of Automatic Operation.

Follow these steps to view the Automatic Status:

1. Navigate to **Main Menu | Debug | Module Statuses | Auto Status.**
2. View the state of operation.

### 16.9.4 Recall Status

The Recall Status displays the current state of the car. The status may show one of the following:

- **Unknown:** The car is not attempting to recall.
- **Moving:** The car is attempting to recall and is in motion or trying to move.
- **Stopped:** The car is attempting to recall but is currently stopped at a non-recall floor.
- **Recall Finished:** The car has reached the requested recall floor, and the doors are in the requested state.

Follow these steps to view the Recall Status:

1. Navigate to **Main Menu | Debug | Module Statuses | Recall Status.**
2. View the state of the Recall status.

### 16.9.5 Fire Status

The Fire Status displays where Fire Phase 1 and 2 are active.

Follow these steps to view the Fire Status:

1. Navigate to **Main Menu | Debug | Module Statuses | Fire Status.**
2. View the Fire status.

### 16.9.6 Counterweight Status

The Counterweight Status displays the state of counterweight derailment. By default, the state is “Unknown” unless the system is in CW Derail mode. In this mode, the state changes to “GoingToNearestDestination”. Once the car arrives at the destination and the doors open, the state is cleared and displays “No State”.

Follow these steps to view the Counterweight Status:

1. Navigate to **Main Menu | Debug | Module Statuses | Counterweight Status.**
2. View the status of the Counterweight.

### 16.9.7 Floor Learn Status

The Floor Learning Status indicates whether the car is currently in the floor learning state.

Follow these steps to view the Floor Learn Status:

1. Navigate to **Main Menu | Debug | Module Statuses | Floor Learn Status.**
2. View the Learn status.

### 16.10 Car Destination

The Car Destination displays the current destination and status of a car within the group.

Follow these steps to view the Car Destination status:

1. Navigate to **Main Menu | Debug | Car Destinations.**
2. View the Car Destination information.



Figure 64: DESTINATION Menu

The **Car Destination** menu displays the following information:

- ◆ **Landing:** Indicates the landing number of the car's current destination. The lowest landing is shown as **1**.
- ◆ **Type:** Displays the call type associated with the destination assignment.
  - **CC - F:** Car Call at the front opening
  - **CC - R:** Car Call at the rear opening
  - **CC - B:** Car Call at both front and rear openings
  - **DIR UP - F:** Hall Call Up or consecutive upward calls at the front opening
  - **DIR UP - R:** Hall Call Up or consecutive upward calls at the rear opening
  - **DIR UP - B:** Hall Call Up or consecutive upward calls at both openings
  - **DIR DN - F:** Hall Call Down or consecutive downward calls at the front opening
  - **DIR DN - R:** Hall Call Down or consecutive downward calls at the rear opening
  - **DIR DN - B:** Hall Call Down or consecutive downward calls at both openings

- ◆ **Mask:** Shows the Hall Call Mask for the car's current destination assignment, based on the Hall Destination Mask Front (HMF) and Rear (HMR) fields. The hall call mask is cleared when the car reaches the destination floor.

### 16.11 Run Counter

The Run Counter displays the total number of runs.

Follow these steps to view the Run Counter:

1. Navigate to **Main Menu | Debug | Run Counter**.
2. View the number of runs completed by the car.

### 16.12 DebugRuns

DebugRuns allows random car and hall calls to be generated and placed into the system for testing purposes.

#### 16.12.1 Dwell Time

The Dwell Time is the time between debug test runs.

Follow these steps to set the Dwell Time:

1. Navigate to **Main Menu | Debug | DebugRuns | Dwell Time**.
2. Set the time between test runs.
3. Scroll right and press **Save**.

#### 16.12.2 Terminal to Terminal

Terminal to Terminal allows the car to run from the bottom terminal landing to the top terminal landing.

Follow these steps to set the car to run Terminal to Terminal:

1. Navigate to **Main Menu | Debug | DebugRuns | Terminal to Terminal**.
2. Select if the Front or Rear doors open while running Terminal to Terminal.
3. Scroll to select whether the car should stop at the other terminal using only the Front or Rear doors, depending on the door configuration.
4. Scroll right and press **Save**.

#### 16.12.3 Floor to Floor

Floor to Floor allows the car to stop at each floor with doors that open either from the front or the rear, depending on the selected configuration.

Follow these steps to set the car to stop at each floor:

1. Navigate to **Main Menu | Debug | DebugRuns | Floor to Floor**.
2. Select if the Front or Rear doors open while running Floor to Floor.
3. Scroll to select whether the car should stop at each floor using only the Front or Rear doors, depending on the door configuration.
4. Scroll right and press **Save**.

#### 16.12.4 Random

Random Calls are automatically selected at random. Random Runs allow the car to stop at various floors in an arbitrary pattern, simulating unpredictable usage scenarios.

Follow these steps to set the car to stop randomly at different landings:

1. Navigate to **Main Menu | Debug | DebugRuns | Random**.
2. Select if the Front or Rear doors open during random runs.
3. Scroll to select whether the car should stop at random floors using only the Front or Rear doors, depending on the door configuration.
4. Scroll right and press **Save**.

#### 16.12.5 Hall Random Runs

Hall Random Runs allow random Hall Calls to be generated to simulate hall board requests. The mask set in this menu determines how the Hall Calls are created.

Follow these steps to set the car to stop at a floor by the randomly selected Hall Call:

1. Navigate to **Main Menu | Debug | DebugRuns | Hall Random Runs**.
2. Select if Hall Calls should be placed randomly.

## 17 About

The About menu displays the following:

- Job Name
- Board Type
- Car Label
- Job Id
- Group Number
- Software Version

Follow these steps to view the job information:

1. Navigate to **Main Menu | About**.

2. View the Job ID information.

---

# **FEATURES & MODES OF OPERATION**

---

## 1 Floors / Security

This section outlines the procedures for configuring floor security settings.

### 1.1 Security Setting

To secure specific floors, the Security setting must be turned **ON** for each applicable opening.

- ◆ **Front Security Mask:** Defines which landings with front openings are secured. These are located at addresses 32-0008 to 32-0010.
- ◆ **Rear Security Mask:** Defines which landings with rear openings are secured. These are located at addresses 32-0012 to 32-0014.

Refer to the **Hydro:Evolved Parameter List** for detailed parameter information.

**NOTE:** The security input must be assigned before configuring which floors require security access.

Follow the steps below to setup security for Front or Rear Car Calls:

1. Navigate to **Main Menu | Setup | Floors | Security (Front or Rear)**.
2. Scroll and select the floors where the front or rear door will open.
  - Setting the floor to **ON** will enable security for that opening.
3. Scroll right and press **Save**.

### 1.2 Enable Hall Security

Enabling Hall Security restricts access to designated floors to authorized users only.

Follow the steps below to enable Hall Security:

1. Navigate to **Main Menu | Setup | Group Setup | Enable Hall Security**.
2. Set to **ON**.
3. Scroll right and press **Save**.

### 1.3 Access Code

The Access Code feature secures Car Calls by requiring a 4-digit code entry. When a Car Call is initiated, the corresponding button lamp flashes, and a limited time is available to enter the code – one digit at a time.

Access Codes are available for a total of 16 landing positions:

- 16 Front landings
- 16 Rear landings
- Or 8 Front + 8 Rear landings

**NOTE:** For applications with more than 16 floors, Access Codes must be offset from lower floors to enable assignment on higher floors. For example, to assign Access Codes to floors 17-20, offset Access Codes from floors 1-4 (refer to section **1.3.4 Offset Floors** for details).

The system compares the entered button sequence with the stored code:

- ◆ If the sequence matches, the Car Call latches.
- ◆ If the code is incorrect or the input time expires, the lamp stops flashing and the sequence must be re-entered starting with the Car Call button.

Additional Notes:

- ◆ Access Code security is bypassed when the car is on Fire Service or EMS.
- ◆ Debugging Car Calls bypasses all Car Call Security features, including Access Codes.

### 1.3.1 Front Door Access Code

Follow the steps below to set up the front door Access Code:

1. Navigate to **Main Menu | Setup | Access Code | Access Codes (Front or Rear)**.
2. Scroll and select the Car Call floor that requires an Access Code.
  - An Access Code may not have been previously set. If an Access Code has not been set, the display shows all dashes.
3. Set the Access Code.

**NOTE:** when a front or rear floor has not been configured, the access code displays “n/a” for that floor.

4. Scroll right and press **Save**.

### 1.3.2 Disabling an Access Code

Follow the steps below to disable an Access Code:

1. Navigate to **Main Menu | Setup | Access Code | Access Codes (Front or Rear)**.
2. Scroll and select the Car Call floor that no longer requires an Access Code.

**NOTE:** An Access Code may not have been previously set. If an Access Code has not been set, the display shows all dashes.

3. Set **all four digits** of the Access Code to the **lowest PI-defined value**.
4. After changing the last digit, the UI will automatically display “- - - -”, indicating the Access Code has been cleared.
5. Scroll right and press **Save**.

### 1.3.3 Additional Front / Rear Door Access Codes

To configure more than 16 Access Codes for front or rear doors, Access Codes must first be disabled on the opposite door. For example, to assign more than 16 front door Access Codes, disable rear door Access Codes.

Follow the steps below to disable Access Codes for front or rear doors:

1. Navigate to **Main Menu | Setup | Access Code | Select Enable Front (or Rear) Doors**.
2. Set to **ON**.
3. Scroll right and press **Save**.

### 1.3.4 Offset Floors

Follow the steps below to offset floors that do not require Access Codes:

1. Navigate to **Main Menu | Setup | Access Code | Offset Floors**.
2. Set the number of floors to offset.
3. Scroll right and press **Save**.

### 1.3.5 Car Call Button Timer

The Car Call Button Timer defines the duration allowed to enter each digit of the Access Code – one digit at a time. The same amount of time is allocated per digit. If the timer expires before the full code is entered, the Car Call button must be pressed again and the entire code re-entered within the configured time limit.

**NOTE:** The default timer value is five seconds per digit.

Follow the steps below to configure the time allowed for entering each Access Code digit:

1. Navigate to **Main Menu | Setup | Access Code | CCB Timer**.
2. Set the time to enter each digit of the Access Code.
3. Scroll right and press **Save**.

## 1.4 Timed Car Call Security

Timed Car Call Security allows Car Calls to be denied during specific times on any day of the week. When Timed Car Call Security is enabled, Car Calls configured with time-based restrictions will not latch.

Access to secured floors resumes under any of the following conditions:

- The defined time period has passed
- Timed Car Call Security is turned OFF
- Car Call Enable Key is activated
- Enable All Car Calls is selected

**NOTE:** If Access Code security is configured, the Access Code will override Timed Car Call Security.

Follow the steps below to configure Front and Rear Timed Car Call Security settings:

1. Navigate to **Main Menu | Setup | Floors | Timed Car Call Security | Enable Floor (Front or Rear)**.
2. Select the front or rear secured floor.
3. Scroll right and press **Save**.
4. To set the security floor for the weekday or weekend:
  - i. **Weekday:** Scroll back to the **Timed Car Call Security** menu and go to step 6.
  - ii. **Weekend:** Scroll back to the **Timed Car Call Security** menu and go to step 13.
5. Select **Start (M-F)**.
6. Set the start time for the Car Call Security.
7. Scroll right and press **Save**.
8. Scroll back to the **Timed Car Call Security** menu.
9. Select **Stop (M-F)**.
10. Set the stop time for the Car Call Security.
11. Scroll right and press **Save**.
12. Select **Start (S-S)**.
13. Set the start time of the Car Call Security.
14. Scroll right and press **Save**.
15. Scroll back to the **Timed Car Call Security** menu.
16. Select **Stop (S-S)**.
17. Set the start time of the Car Call Security.
18. Scroll right and press **Save**.

## 1.5 Timed Hall Call Security

Timed Hall Call Security allows Hall Calls to be restricted during specific time periods on any day of the week. When this feature is enabled, time-secured Hall Calls will not latch. The feature can be activated either through the controller UI or by programming the Enable Hall Call Timed Security input.

Once the configured time period has passed or Timed Hall Call Security is turned OFF, Hall Calls resume normal operation. If the feature is enabled via the Enable Hall Call Timed Security input, activating the Enable All Hall Calls input will also restore normal Hall Call functionality.

When Timed Hall Call Security is active, any pending Hall Calls to non-secured floors are canceled. However, all latched Car Calls will continue to be serviced.

Follow the steps below to configure front and rear Timed Hall Call Security:

1. Enable Hall Call Security (refer to section **1.2 Enable Hall Security**).
2. Navigate to **Main Menu | Setup | Floors | Timed Hall Call Security | Enable Floor (Front or Rear)**.
3. Select the front or rear secured floor.
4. Scroll right and press **Save**.
5. To set the security floor for the weekday or weekend:
  - i. **Weekday:** Scroll back to the **Timed Hall Call Security** menu and go to step 7.
  - ii. **Weekend:** Scroll back to the **Timed Hall Call Security** menu and go to step 14.
6. Select **Start (M-F)**.
7. Set the start time for the Hall Call Security.
8. Scroll right and press **Save**.
9. Scroll back to the **Timed Hall Call Security** menu.
10. Select **Stop (M-F)**.
11. Set the stop time for the Hall Call Security.
12. Scroll right and press **Save**.
13. Select **Start (S-S)**.
14. Set the start time of the Hall Call Security.
15. Scroll right and press **Save**.
16. Scroll back to the **Timed Hall Call Security** menu.
17. Select **Stop (S-S)**.
18. Set the start time of the Hall Call Security.
19. Scroll right and press **Save**.

## 1.6 Dynamic Security

Dynamic Security activates the Car Call Security and Hall Call Security features for a user-defined duration (based on specific dates and times).

This feature is accessible via the GUI and Local Monitoring Apps.

Under Dynamic Security, floor-specific security cannot be customized:

- If any front door requires Car Call or Hall Call Security, all front doors will be secured.
- If any rear door requires security, all rear doors will be secured.

In group operation, Car Call Security can be selectively enabled on specific cars. However, Hall Call Security will be applied automatically to all cars once enabled.

## 2 Lockout Passcode

The Lockout Passcode is a screen lockout feature that restricts controller access to authorized elevator personnel only.

**NOTE:** Once the Lockout Passcode is set, the controller will prompt for it in the following scenarios:

- After 30 seconds of inactivity on the Home Page
- After 15 minutes of inactivity within the Main Menu

Follow the steps below to configure the Lockout Passcode:

1. Navigate to **Main Menu | Setup | Miscellaneous | Lockout Passcode**.
2. Enter the lockout passcode.
3. Scroll right and press **Save**.

## 3 Payment Passcode

The Payment Password is the controller password required for Normal operation.

Follow the steps below to enter the Payment Passcode:

1. Navigate to **Main Menu | Setup | Miscellaneous | Payment Passcode**.
2. Enter the payment passcode.

**NOTE:** The passcode will be provided once payment is confirmed.

3. Scroll right and press **Save**.

## 4 Parking

Parking automatically sends the car to a designated floor after a specified period of inactivity, defined by the Parking Timer.

## 4.1 GUI Parking

When enabled, Dynamic Parking is configured through the DAD unit using the GUI interface. After a car has been idle for the configured time, it travels to a designated floor based on Hall Call history and parks. While parked, the car remains active and will respond immediately to all Hall and Car Calls.

Dynamic Parking can be configured for multiple cars in a group. In such cases, a Primary and Secondary designated floor can be assigned. If the car parked at the Primary floor answers a Hall or Car Call, the car at the Secondary floor relocates to the Primary floor. If another car in the group becomes idle after the set period, it will park at the Secondary designated floor.

For configuration details, refer to the **C4 & Hydro:Evolved GUI Manual**.

Follow the steps below to enable Dynamic Parking via DAD unit:

1. Navigate to **Main Menu | Setup | Miscellaneous | Parking | GUI Parking**.
2. Set to **ON**.
3. Scroll right and press **Save**.

## 4.2 Parking Timer

The Parking Timer defines the duration a car remains idle without any commands before initiating parking.

Follow the steps below to configure the Parking Timer:

1. Navigate to **Main Menu | Setup | Miscellaneous | Parking | Parking Timer**.
2. Set the time prior to parking.

**NOTE:** If the timer is set to zero, parking will be disabled.

3. Scroll right and press **Save**.

## 4.3 Parking Floor

The Parking Floor is the floor to which the car travels and parks after the Parking Timer elapses.

Follow the steps below to assign the Parking Floor:

1. Navigate to **Main Menu | Setup | Miscellaneous | Parking | Parking Floor**.
2. Set the Parking Floor.
3. Scroll right and press **Save**.

## 4.4 Parking Door Open

When parked, the car door can either remain closed or stay open.

Follow the steps below to configure the door behavior when the car is parked:

1. Navigate to **Main Menu | Setup | Miscellaneous | Parking | Parking Door Open**.
2. Set to **ON**.
3. Scroll right and press **Save**.

## 5 Direction Counter Limit

Direction Counter Trip Reset takes the car out of service after registering a predefined number of direction changes. Each change represents a shift in travel direction. For more information, refer to the **C4-H Testing Procedures**.

Follow the steps below to set the Direction Counter Limit:

1. Navigate to **Main Menu | Setup | Miscellaneous | Dir. Counter Limit**.
2. Enter the access code.

**NOTE:** the access code is the payment passcode (refer to section **3 Payment Passcode**). For jobs using software releases older than 6510, contact Technical Support to request User Manual version 1.11.

3. Set the maximum number of direction changes desired.
4. Scroll right and press **Save**.

## 6 Direction Change Delay

Direction Change Delay is the configured time the car waits before responding to car calls or hall calls in the opposite direction. This delay allows passengers time to enter car calls in the same direction the car was previously traveling.

Follow the steps below to set the Direction Change Delay:

1. Navigate to **Main Menu | Setup | Miscellaneous | Direction Change Delay**.
2. Set the time delay before the car begins responding to calls in the opposite direction.
3. Scroll right and press **Save**.

## 7 OOS

Elevators can be taken Out of Service (OOS) for maintenance or other operational needs. This operation can be automatically engaged when some predefined high priority faults during a specific time are detected by the control system.

### 7.1 Disable OOS

The Disable OOS feature prevents the car from entering Out of Service mode, even if the Hourly Fault Limit is exceeded or the OOS input is active.

Follow the steps below to Disable OOS:

1. Navigate to **Main Menu | Setup | Miscellaneous | OOS | Disable OOS**.
2. Set to **ON**.
3. Scroll right and press **Save**.

## 7.2 Hourly Fault Limit

The Hourly Fault Limit is the maximum number of faults permitted within one hour before the car is taken out of service. The car remains out of service until the one-hour window has elapsed.

Follow the steps below to set the Hourly Fault Limit:

1. Navigate to **Main Menu | Setup | Miscellaneous | OOS | Hourly Fault Limit**.
2. Set the number of logged faults allowed per hour.
3. Scroll right and press **Save**.

## 7.3 Maximum Starts Per Minute

The Maximum Starts Per Minute defines how many times a car can initiate a run in automatic operation within one minute. If this limit is exceeded, the car is taken out of service and remains so until the one-minute window has elapsed.

Follow the steps below to set the Maximum Starts Per Minute:

1. Navigate to **Main Menu | Setup | Miscellaneous | OOS | Maximum Starts Per Minute**.
2. Adjust the value as required.
3. Scroll right and press **Save**.

## 7.4 Disable PI OOS

When PI OOS is disabled, OOS will not flash on the PI display when the car is out of group.

Follow the steps below to Disable PI OOS:

1. Navigate to **Main Menu | Setup | Miscellaneous | OOS | Disable PI OOS**.
2. Set to **ON**.
3. Scroll right and press **Save**.

## 8 Reset Service

The Reset Service feature places the car out of service after a defined maximum number of trips.

Follow the steps below to set the maximum number of trips before the car goes out of service:

1. Navigate to **Main Menu | Debug | Edit Parameters**.
2. Refer to the **Hydro:Evolved Parameter List**:
  - i. Set the **Reset Service Code**.
  - ii. Set the maximum **Number of HC Trips**.

## 9 Replay Feature

The Replay Feature displays the car's state before, during, and after a Fault or Alarm event.

**NOTE:** If the total time range of an event exceeds 90 seconds, the Replay Feature will generate multiple entries for the same event.

The Replay Feature allows filtering of specific data points to track, including Car Position, Car Speed, Faults, and Alarms. Multiple Faults and Alarms can be selected simultaneously for tracking. Car data can be viewed at any point within the event timeline. Available data includes Floor Label, Position, Car Speed, Motion, and the states of Inputs and Outputs.

Additional features include the ability to download the event and view it in full-screen mode.

For detailed instructions, refer to the **C4 & Hydro:Evolved GUI Manual**.

## 10 Smartrise Air Mobile Application

The Smartrise Air mobile application provides a remote interface for performing software updates. The application automatically scans for nearby controller units, eliminating manual pairing and complex setup. Software updates are downloaded directly from the cloud, ensuring controllers remain up to date with the latest features and enhancements.

The app can be downloaded from: <https://smartrise.us/smartrise-air>

## 11 Data Acquisition Device Unit

Each Smartrise Controller includes a pre-wired DAD Unit equipped with a Graphical User Interface Application (GUI).

Refer to the **C4 & Hydro:Evolved GUI Manual** for additional information.

### 11.1 DAD Status

The DAD Status screen displays the communication and operational status of the DAD Unit.

Follow the steps below to view the DAD status:

1. Navigate to **Main Menu | Status | Dad Status**.
2. View the status of the DAD unit.

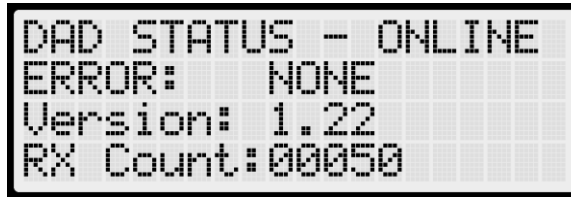

Figure 65: DAD STATUS Menu

The **DAD Status** menu displays the following:

- **DAD STATUS:** Indicates whether the DAD unit is **ONLINE** or **OFFLINE**
- **ERROR:** Displays the current fault if the DAD unit is experiencing an issue. A red LED blinking on the DAD unit signifies an active error.
- **Version:** Shows the current software version installed on the DAD unit.
- **RX Count:** Displays the number of communication packets the controller is receiving from the DAD unit.

## 12 Cross Registration

Cross Registration (XReg) allows the controller dispatching system to interface with non-Smartrise controllers.

### 12.1 XReg Cars

Cross Registration Cars defines the number of cars from the legacy system included in dispatching.

Follow the steps below to set the number of XREG Cars:

1. Navigate to **Main Menu | Setup | Group Setup | XReg Cars**.
2. Enter the number of cars from the legacy system.
3. Scroll right and press **Save**.

### 12.2 XReg Dest Timeout

If a car is assigned a Cross Registration destination and does not respond within a defined period, the car is temporarily removed from the group. The car is reinstated once the Cross Registration timeout has elapsed.

Follow the steps below to set the Cross Registration Destination Timeout:

1. Navigate to **Main Menu | Setup | Group Setup | XReg Destination Timeout**.
2. Set the time for a Cross Registration car to answer a Car Call prior to another car responding.
  - If set to zero, this feature will be disabled.
3. Scroll right and press **Save**.

### 12.3 XReg Dest Offline Timeout

The Cross Registration Offline Timeout defines the duration a car remains out of the group after failing to answer hall calls.

Follow the steps below to set Cross Registration Destination Offline Timeout:

1. Navigate to **Main Menu | Setup | Group Setup | XReg Destination Offline Timeout**.
2. Set the time a Cross Registration car should stay out of the group.
  - If set to zero, this feature is disabled.
3. Scroll right and press Save.

### 12.4 XReg Destination

The system monitors the destination assigned to each Car Call and Hall Call within the group. The display indicates the type of call and whether it is for a Front or Rear opening. When a Hall Call is placed, the corresponding mask reflects the Hall Call being answered. To view the destination of each individual car within the group, use the Up or Down buttons.

Follow the steps below to view the Car Call Destination:

1. Navigate to **Main Menu | Debug | XReg Destination**.
2. View the destination of the car within the group.

### 12.5 XReg Data

Cross Registration Data displays detailed information about the status of each Alien Car.

Follow the steps below to view the status of the car:

1. Navigate to **Main Menu | Debug | XReg Data**.
2. From the Car Data Overview Status, press the right button.
3. From the Hall Mask Status, press the right button.
4. From the Front Opening Map Status, view the status and press the right button.
5. From the Rear Opening Map Status, view the status and press the right button.
6. From the Emergency Power Status, view the status and press the right button.
7. From the Fire Emergency Power Status, view the status.

## 13 Construction Mode

In Construction Mode, the elevator is configured to operate specifically during building construction or renovation. This mode accommodates the specific needs of the building process as the elevator system is physically incomplete.

Refer to the **Hydro:Evolved Installation Guide** for more information.

## 14 Inspection Mode

In Inspection Mode, the elevator is removed from automatic operation and placed under manual control. This mode is typically used for maintenance, inspection, or troubleshooting by authorized personnel.

During Inspection operation, the elevator travels at either the rated leveling speed or the high valve speed. If the car is outside the slowdown region and parameter 01-0400 is set to ON, the elevator will move at the high valve speed. Otherwise, it will operate at the rated leveling speed.

Emergency stop buttons remain functional to halt the elevator if needed.

Automatic door operation is disabled, requiring doors to be opened and closed manually if necessary.

Normal call buttons (inside and outside the cab) are deactivated.

### 14.1 Machine Room, CT, Hoistway Access, and Pit Inspections

**Machine Room Inspection** is activated using the MR INSPECTION switch. The car can be moved using the UP and DOWN buttons located on the MR board. This form of inspection is overridden by Hoistway Access and CT Inspection.

**CT Inspection** is the highest mode of inspection and overrides all other forms. The car is placed on CT Inspection using the INSPECTION switch located on the top of the Car Run Box. A run can be asserted using the Enable, UP, or DOWN commands from the Run Box.

**Hoistway Access Inspection** allows the car to run with doors open at a terminal landing. The Hoistway Access Inputs are wired back to each controller's MR board. The car must be at a terminal landing to use this inspection mode.

**Pit Inspection** is activated by disconnecting the 24 V to input 501 on the MR board, by configuring parameter Enable\_Pit\_Inspection (01-0037) to ON, and my setting DIP B4 t the ON position. Input 501 is a fixed input for this mode.

## 15 Hoistway Access Mode

The Hoistway Access safely and securely moves the car at the terminal landings to gain access to either the pit or the top of the hoistway. Normally, this is done via a key switch that enables the top or bottom access inputs on the controller. The car will only move if the doors are open.

Follow the steps below to access the Hoistway:

1. Navigate to **Main Menu | Setup | Hoistway Access**.
2. If the hoistway is being accessed from the top of the hoistway or the pit:
  - i. If the hoistway is being accessed from the top of the hoistway, go to step 3.

- ii. If the hoistway is being accessed from the bottom of the hoistway, go to step 14.
3. Scroll and select **Allowed Distance Top**.
4. Scroll and select the distance from the car to the hoistway.
5. Scroll right and press **Save**.
6. Press the left button until the **Hoistway Access** menu displays.
7. Scroll and select **Top Floor**.
8. Select the top floor just below the hoistway.
9. Scroll right and press **Save**.
10. Press the left button until the **Hoistway Access** menu displays.
11. Scroll and select **Top Opening**.
12. Scroll and select the top floor just below the hoistway.
13. Scroll right and press **Save**.
14. Press the left button until the **Hoistway Access** menu displays.
15. Scroll and select **Allowed Distance Bottom**.
16. Scroll and select the distance from the car to the pit.
17. Scroll right and press **Save**.
18. Press the left button until the **Hoistway Access** menu displays.
19. Scroll and select **Bottom Floor**.
20. Select the bottom floor just above the pit.
21. Scroll right and press **Save**.
22. Press the left button until the **Hoistway Access** menu displays.
23. Scroll and select **Bottom Opening**.
24. Scroll and select the bottom floor the car opens just above the pit.
25. Scroll right and press **Save**.
26. Press the left button until the **Hoistway Access** menu displays.
27. Scroll and select **Hoistway Access Slide Distance**.

28. Enter the maximum distance the car is allowed to be within the top or bottom door zone.
29. Scroll right and press **Save**.

## 16 Car To Lobby Floor Mode

In Car To Lobby operation, the elevator control system services all latched car calls, bypasses latched hall calls, then directs the car to the designated Car To Lobby floor.

Follow the steps below to select the Car to Lobby Floor:

1. Navigate to **Main Menu | Setup | Miscellaneous | Car to Lobby Floor**.
2. Set the lobby floor the car automatically travels to.
3. Scroll right and press **Save**.

## 17 Wander Guard Mode

Wander Guard is a security mode of operation that prevents unauthorized individuals from accessing designated floors. The car continues normal operation but skips floors assigned to Wander Guard. If the car does stop at a restricted floor, the doors remain open and the car does not proceed until conditions are cleared.

To set the controller to Wander Guard mode, refer to the **Hydro:Evolved Inputs & Outputs**.

Follow the steps below to set the Wander Guard floors:

1. Navigate to **Main Menu | Setup | Floors | Wander Guard**.
2. Set the Wander Guard floors.
3. Scroll right and press **Save**.

## 18 Sabbath Mode

In Sabbath operation, the elevator controller is specialized to accommodate the needs of individuals observing the Sabbath by automatically operating the elevator without direct human intervention.

The Sabbath operation can be activated either by a key switch or by the controller when the clock reaches the Sabbath start time. Once in Sabbath operation, the elevator car functions automatically by going to each door that has a valid Sabbath opening and skipping those without a valid Sabbath opening. Sabbath operation has a door dwell timer different than the standard door dwell time. The car exits Sabbath operation if the Sabbath key is turned off or once the controller clock reaches the Sabbath end time.

Refer to the **Hydro:Evolved Parameter List** for full parameter details.

### 18.1 Procedure to Set Sabbath Operation

There are three setup options:

- Key Enable Only
- Timer Enable Only
- Key or Timer Enable

Follow the steps below to set the Sabbath Operation:

1. Navigate to **Main Menu | Setup**.
2. To setup the Sabbath operation by Key Enable Only, Timer Enable Only, or Key or Timer Enable:
  - i. If the Sabbath operation is being set by Key Enable Only, go to step 3.
  - ii. If the Sabbath operation is being set by Timer Enable Only, go to step 35.
  - iii. If the Sabbath operation is being set by Key or Timer Enable, go to step 51.

3. Navigate to **Setup | Setup I/O**.
4. Select **Setup Inputs**.
5. From the **Select Board** menu, scroll and select the board the Sabbath key is wired to.
6. From the **Input** menu, scroll and select the configuration to be used as the Sabbath input.

**NOTE:** the X input is a representation of a number between 3-8.

7. Scroll right.
8. Scroll and select **Auto Operation**.
9. Scroll right.
10. Scroll and select **Sabbath**.
11. Scroll right and press **Save**.
12. Press the left button and navigate to **Setup | Sabbath**.
13. To setup the Sabbath operation with Key Enable Only or Key or Timer Enable Only:
  - i. If the Sabbath Operation is being setup for Key Enable Only, go to step 14.
  - ii. If the Sabbath Operation is being setup for Key or Timer Enable, go to step 18.

14. Scroll and select **Key Enable Only**.
15. Press the up button and select **ON**.
16. Scroll right and press **Save**.
17. Press the left button until the Sabbath menu is displayed.
18. Select **Floors Opening (F)**.

19. Scroll and select the front doors for each floor that opens during Sabbath.

**NOTE:** The doors that should open must be set to On.

20. Scroll right and press **Save**.

21. Press the left button until the **Sabbath** menu is displayed.

22. Scroll and select **Floors Opening (R)**.

23. scroll and select the rear doors for each floor that opens during Sabbath.

24. Scroll right and press **Save**.

25. Press the left button until the **Sabbath** menu is displayed.

26. Scroll and select **Destinations Up**.

27. Scroll and select the up destination for the Sabbath.

- Ensure the highest down destination is below the highest up destination.
- Ensure the lowest down destination is above the lowest up destination.
- Up destinations should be different from down destinations.

28. Scroll right and press **Save**.

29. Press the left button until the **Sabbath** menu is displayed.

30. Scroll and select **Destinations Down**.

31. Scroll and select the down destination for the Sabbath.

32. To setup the Sabbath Operation for Key Enable Only, Timer Enable Only, or Key or Timer Enable:

- i. If the Sabbath Operation is being setup for Key Enable Only, go to step 34.
- ii. If the Sabbath Operation is being setup for Timer Enable Only, go to step 34.
- iii. If the Sabbath Operation is being setup for Key or Timer Enable, go to step 33.

33. To setup the Sabbath Operation for Key or Timer Enable complete:

- i. If the setup for Sabbath for Key or Timer Enable is complete, go to step 34.
- ii. If the setup for Sabbath for Key or Timer Enable is not complete go to step 38.

34. Scroll right and press **Save**. The process ends.

35. Navigate to **Setup | Sabbath**.

36. Scroll and select **Timer Enable Only**.

37. Press the up button and select **ON**.

38. Scroll right and press **Save**.
39. Press the left button until the **Sabbath** menu is displayed.
40. Scroll and select **Friday Start Time**.
41. Set the time the Sabbath starts.
42. Scroll right and press **Save**.
43. Press the left button until the **Sabbath** menu is displayed.
44. Scroll and select **Saturday End Time**.
45. Set the time the Sabbath ends.
46. Scroll right and press **Save**.
47. Press the left button until the **Sabbath** menu is displayed.
48. Scroll and select **Door Dwell Timer**.
49. Set the time the door stays open.
50. Scroll right and press **Save**. Go to step 17.
51. Navigate to **Setup | Sabbath**.
52. Scroll and select **Key or Timer Enable**.
53. Press the up button and select **ON**.
54. Scroll right and press **Save**.
55. Press the left button until the **Setup** menu is displayed and go to step 3.

## 19 Hydro Mode Settings

This section includes configurable settings that enhance hydraulic elevator performance and protection under specific operating conditions.

### 19.1 Viscosity Mode

In Viscosity mode, triggered when oil becomes too viscous, the system cycles between Run and Rest periods.

- A cycle = one Run followed by one Rest.
- Service calls may be allowed or disallowed during cycles.
- If calls are allowed, they interrupt the cycle, after which the system resumes the sequence

To enable this operation, set the Run Time, the Rest Time, the number of Cycles Allowed, and whether to Allow Calls or not.

### 19.1.1 Run Time

Follow the steps below to set the Run Time for Viscosity operation:

1. Navigate to **Main Menu | Setup | Hydro | Viscosity | Run Time 1min.**
2. Set the desired Run Time in minutes.
3. Scroll right and press **Save**.

### 19.1.2 Rest Time

Follow the steps below to set the Rest Time for Viscosity operation:

1. Navigate to **Main Menu | Setup | Hydro | Viscosity | Rest Time 1min.**
2. Set the desired Rest Time in minutes.
3. Scroll right and press **Save**.

### 19.1.3 Cycles Allowed

Follow the steps below to set the Cycles Allowed for Viscosity operation:

1. Navigate to **Main Menu | Setup | Hydro | Viscosity | Cycles Allowed.**
2. Set the desired number of cycles.
3. Scroll right and press **Save**.

### 19.1.4 Allow Calls

Follow the steps below to set the Allow Calls for Viscosity operation:

1. Navigate to **Main Menu | Setup | Hydro | Viscosity | Allow Calls.**
2. Set to **ON**.
3. Scroll right and press **Save**.

## 19.2 Low Oil Mode

The Low Oil feature renders the elevator inoperative during normal operation if the liquid level in the tank falls below the permissible minimum.

- This feature is manually activated via an input. Refer to the **Hydro:Evolved Inputs & Outputs**.
- This feature is also automatically activated when the predefined Max Run Time is exceeded. In this case, the MRA will display a Low Oil MLT Fault. Refer to the **Hydro:Evolved Faults & Alarms**.
- Once activated, the car is automatically brought down to the lowest landing when the doors are closed.

## 20 VIP Mode

A car configured for VIP will be selected when this mode of operation is activated by a specially configured Hall board.

- The car services all existing Car Calls and ignores all Hall Calls until all Car Calls have been cleared.
- Once all Car Calls have been serviced, the car responds to the VIP Hall Call and opens the doors.
- There is a five-second minimum allowed for a new Car Call entry.
- After all Car Calls have been serviced, the car exits VIP mode.

## 21 Active Shooter Mode

Active Shooter is a type of auto operation that prevents a shooter from having easy access to an elevator. This mode is enabled via a key switch.

### When Active Shooter is enabled:

- The car automatically closes its doors.
- The PI Display alternates between the floor label and "CR" (Crisis).
- Cars do not respond to any Hall Calls or Car Calls.
- All cars in the group are recalled to an alternate recall floor; the doors open and remain open.

## 22 Marshal Mode

Marshal Mode is a type of auto operation that removes the car from group service. It is enabled via a key switch input.

### When Marshal Mode is enabled:

- The car clears all latched Car Calls and Hall Calls.
- The car stops at the next available landing.
- Both Front and Rear doors remain closed, regardless of passengers inside.
- The car ignores all Car Calls and Hall Calls, and the Door Open and Door Close buttons are disabled.
- The marshal uses the remote controller to issue car calls.

### Marshal Mode behavior:

- Upon reaching the landing, the doors stay closed.
- The marshal must press and hold the Door Open button until the doors are fully open. If released early, the doors close again.
- Once the doors are fully open, they remain open.
- To close the doors, the marshal must press and hold the Door Close button until the doors are fully closed. If released early, the doors reopen.
- If multiple car calls are made, the car waits 10 seconds at the landing for the Door Open button to be pressed. If not pressed within this time, the car proceeds to the next latched car call.
- If the Door Open button is pressed in time, the car retains the remaining latched car calls and dispatches only after the doors are fully closed.

### To disable Marshal Mode:

- Turn off the key switch input. The car rejoins the group and resumes normal operation.

To set the controller to Marshal Mode, refer to the **Hydro:Evolved Inputs & Outputs**.

## 23 Swing Mode

Swing Operation removes a car from the group and allows it to respond exclusively to calls from the designated swing riser. The car will first complete all existing car calls before servicing the swing hall call.

### 23.1 Configuring Swing Mode Input

If Swing Operation is activated by a switch, the controller inputs must be configured accordingly.

Follow these steps to configure the inputs for Swing Operation:

1. Navigate to **Main Menu | Setup | Setup I/O | Setup Inputs**.
2. From the **Select Board** menu, scroll and select the board to be assigned.
3. From the **Input** menu, scroll and select an unused input.
4. Scroll right.
5. Scroll and select **Auto Operation**.
6. Scroll right.
7. Scroll and select **Enable Swing**.
8. Scroll right and press **Save**.
9. Wire the key switch to the input.

When 24 VDC is applied to this input, the car enters Swing Operation and responds only to calls from the designated riser.

### 23.2 Calls Enable Swing

To configure Swing Operation to be activated by the swing riser call, follow these steps:

1. Navigate to **Main Menu | Setup | Swing | Calls Enable Swing**.
2. Set to **ON**.
3. Scroll right and press **Save**.

### 23.3 Swing Opening

Swing doors, typically used in high-traffic areas, open and close automatically. Swing openings can be enabled on multiple landings.

To configure landings for front or rear Swing openings:

1. Navigate to **Main Menu | Setup | Door Setup | Swing Openings (Front or Rear)**.
2. Select the landings where swing openings are enabled.
3. Scroll right and press **Save**.

### 23.4 Swing Call Mask

The Swing Call Mask identifies which hall boards' function sets are recognized as special swing hall calls. Swing calls activate Swing Operation for the designated car(s).

Configure the Swing Call Mask as follows:

1. Navigate to **Main Menu | Setup | Group Setup | Swing Call Mask**.
2. Select the cars assigned to Swing Operation.
3. Scroll right and press **Save**.

### 23.5 Stay Active in Group

When a car is set to stay active in the group, it can be operated by any riser during Swing Operation. Inputs must be configured – refer to section **23.1 Configuring Swing Mode Input** if not set.

To enable this feature:

1. Navigate to **Main Menu | Setup | Swing | Stay In Group**.
2. Set to **ON**.
3. Scroll right and press **Save**.

### 23.6 Idle Timer

The Idle Timer determines how long the car remains in Swing Operation after servicing all calls. Inputs must be configured – refer to section **23.1 Configuring Swing Mode Input** if not set.

To configure the Idle Timer:

1. Navigate to **Main Menu | Setup | Swing | Idle Timer**.
2. Set the idle time.
3. Scroll right and press **Save**.

## 24 Emergency Power

Emergency Power Operation (EPO) enables elevators to provide limited, prioritized service during a building power failure, using a backup power source such as a generator.

When EPO is active, each elevator in a group is individually recalled to a designated recall floor based on a predefined priority. After recall, the car doors remain open for a set duration (defined by the Door Recall Time), then close automatically. The system then allows a specified number of cars to resume operation at the designated Emergency Power speed.

### 24.1 Key Parameters

The key configuration parameters that define how the Emergency Power Operation behaves for both single and multiple group elevator systems are as follows:

- ◆ **08-0145:** Sets the group priority in multi-group systems.
- ◆ **08-0186:** Sets the maximum number of cars that can operate under Emergency Power per group.
- ◆ **08-0129:** Sets the car priority in a single-group system when the Auto Select input is active and when the Recall operation is active.
- ◆ **08-0230:** Sets the total number of cars across all interconnected groups that can operate on Emergency Power.

### 24.2 Emergency Power Inputs

The controller relies on several input signals to manage elevator behavior during Emergency Power events. Each input plays a specific role in transitioning the system between different states.

Input Name	Description
<b>Emergency Power On</b>	Signals the car to enter EPO. The car remains stopped until “Generator Up to Speed” is active.
<b>Generator Up to Speed</b>	Signals that the generator is ready and supplying power. Once active, selected cars can resume Normal operation.
<b>Pre-Transfer</b>	Switches from Emergency to Normal power.
<b>Select [1-8]</b>	These manual inputs are used to release specific cars into Normal operation after recall.
<b>Auto Select</b>	When the manual input is inactive, a predetermined number of cars automatically return to Normal operation once all recalls are completed.

### 24.3 Emergency Power Outputs

Outputs provide feedback signals that indicate the current state or actions of the elevators during Emergency operation.

Output Name	Description
<b>Lamp At Recall</b>	Activates when the car has completed Emergency Power recall.
<b>Lamp On EP</b>	Indicates that the car is operating under Emergency Power operation.
<b>Select [1-8]</b>	Indicates that a car is either recalling or has been released to operate normally during emergency power.

## 24.4 Operation Modes

During an emergency power event, the system can operate in either simplex or multi-group mode. This section explains how each mode behaves and how to configure the number of cars permitted to run on emergency power.

### 24.4.1 Simplex Operation

In simplex operation, when an emergency power event occurs, the car performs an automatic recall to its assigned Recall Floor. Once the car reaches the Recall Floor, the doors open and remain open for a programmed duration. After this time expires, the doors close automatically. The car may then resume service at the configured Emergency Power speed.

### 24.4.2 Multiple Group Operation

In multi-group operation, during an emergency power event, the cars within the affected group are recalled sequentially, following their defined priority order, to the designated Recall Floor. After all recalls have been completed, only the number of cars that the generator can support will be permitted to resume operation.

When operating in multi-group mode, Emergency Power management is coordinated across all interconnected elevator groups. The system maintains balanced operation while ensuring that both per-group and system-wide limits on the number of active cars are not exceeded.

## 24.5 Number of Active Cars

The maximum number of cars permitted to operate under Emergency Power per group can be configured.

To set the Number of Active Cars, follow these steps:

1. Navigate to **Main Menu | Setup | E-Power | Number Active Cars**.
2. Choose the desired number of cars.
3. Scroll right and press **Save**.

## 24.6 Setting the Priority Car

The priority car is the first car recalled and allowed to operate during emergency power. This car takes precedence when releasing cars for normal operation under EPO.

To set the Priority Car, follow these steps:

1. Navigate to **Main Menu | Setup | E-Power | Priority Car**.
2. Choose the desired car.
3. Scroll right and press **Save**.

## 24.7 Pretransfer Stall Behavior

This option controls how cars behave during a pretransfer event when switching from Emergency to Normal power.

- ◆ **Enabled (ON):** Cars stop immediately at their current position and enter a faulted state when the Pretransfer input is active.
- ◆ **Disabled (OFF):** Cars travel to the nearest floor with a valid opening.

Use this setting when the system wiring includes a Pretransfer input to pause cars during the power transition.

To enable or disable Pretransfer Stall, follow these steps:

1. Navigate to **Main Menu | Setup | E-Power | Pretransfer Stall**.
2. Choose **ON** or **OFF**.
3. Scroll right and press **Save**.

## 24.8 Privileged Modes

Each car operates independently. If a car remains idle during recall, it is taken out of service until the emergency power service cycle is complete. Privileged modes of car operation can postpone recalls until the car has been idle for 2-3 minutes, as defined by parameter **08-0232**. If the emergency power recall is repeated for any reason, privileged cars that have already postponed the original recall cycle will not be delayed again. For the list of parameters, refer to the **Hydro:Evolved Parameter List**.

The following is the order of privileged modes of operation:

- Fire Phase 1 and Phase 2 Operation
- EMS Phase 1 and Phase 2 Operation
- Manual Modes of Operation (Inspection States)
- Independent Service Operation
- Attendant Operation

### 24.8.1 Fire Phase 1 and Phase 2 Operation

Fire Phase 1 and Phase 2 are modes of operation triggered when smoke or heat is detected. See section **26 Fire** for more details.

### 24.8.2 EMS Phase 1 and Phase 2 Operation

EMS Phase 1 and Phase 2 are modes of operation that allow medical personnel to control the elevator during a medical emergency. See section **28 Emergency Medical Service** for more information.

### 24.8.3 Cars in Manual Modes of Operation (Inspection States)

Cars remain idle for 2-3 minutes after emergency power is activated. If a car is switched to or from **MR, CT, IC, or HA** inspection mode while emergency power is active, the entire emergency power recall and allocation process restarts with the updated car configuration.

#### 24.8.4 Independent/Attendant Service Operation

Cars operating in Independent or Attendant Service remain idle for 2–3 minutes from the start of the emergency power cycle. These cars are not recalled but are treated as normal cars during allocation. If selected, they return to their original service mode.

#### 24.9 Intergroup Communication

Communication between groups is enabled via a Riser board configured as Riser 4. DIP switches 1, 2, and 8 must be ON.

- ◆ **CAN 1** of a Riser 4 board connects to the car-group GROUP network.
- ◆ **CAN 2** of a Riser 4 board connects in parallel with the CAN 2 of other Riser 4 boards in interconnected groups. This network is referred to as the Intergroup network.

During emergency power operation:

- ◆ The Riser 4 board disables all hall network traffic on CAN 2 and maintains only the Intergroup network.
- ◆ It continues to communicate with other Riser 4 boards in different groups and is notified when a group goes offline.
- ◆ If a group does not respond within 30 seconds, it is marked as offline.
- ◆ If a group is added to the Intergroup network during emergency power, all groups repeat the recall process.

### 25 Earthquake

The Earthquake Seismic Event and Earthquake Counterweight Derail Event determine car positioning based on the nature of the event.

#### 25.1 Enable Earthquake

When seismic activity is detected, the elevator car stops at the nearest floor and the doors open automatically to allow passengers to safely exit.

Follow the steps below to enable Earthquake mode:

1. Navigate to **Main Menu | Setup | Earthquake | Enable Eq.**
2. Select **Enable Earthquake.**
3. Scroll right and press **Save.**

#### 25.2 Set CW Position

Counterweights provide a balancing force for the car's payload. Their position is set to the midpoint of the hoistway.

Follow the steps below to set the Counterweight Position:

1. Manually move the car to the mid-point location.

**NOTE:** Place the car in CT Inspection Mode and move it so that it aligns with the center of the counterweight.

2. Navigate to **Main Menu | Setup | Earthquake | Set CW Pos.**
3. Select the position. This stores the car's current location as the counterweight midpoint.
4. Scroll right and press **Save**.

### 25.3 Earthquake Status

The Earthquake Status menu displays the input status of fire, smoke, and earthquake-related emergency signals.

Follow the steps to view the Fire/Earthquake Status.

1. Navigate to **Main Menu | Status | Inputs | Fire/Earthquake.**
2. View the status of all selected fire and earthquake emergency services.

## 26 Fire

Fire Phase 1 and Fire Phase 2 are modes that allow control of the elevator car(s) during a fire situation.

- ◆ Fire Phase 1 is activated when smoke is detected – either automatically via a smoke sensor or manually using a key switch. The elevator car(s) will travel to a designated recall floor with the doors open. If the smoke is detected at the recall floor, the car(s) will proceed to an alternate landing. If the fire is in the Machine Room (MR), the shunt operation removes main power from the controller. The MR board triggers an external shunt disconnect device after the car has reached the recall floor and the doors have opened.

The shunt operation follows this sequence:

- A smoke sensor is activated.
  - The car(s) travel to the recall floor and open the doors.
  - The shunt output activates and opens the Shunt Bypass switch, disconnecting power from the main disconnect.
- ◆ Fire Phase 2 allows firefighters or emergency personnel to take control of the elevator from inside the car using a key switch.

### 26.1 Main Recall

The Main Recall is the designated floor the car is automatically returned to during a fire event.

#### 26.1.1 Main Recall Floor

Follow the steps below to set the Main Recall Floor:

1. Navigate to **Main Menu | Setup | Fire | Main Recall | Floor.**
2. Enter the designated recall floor.

3. Scroll right and press **Save**.

### 26.1.2 Main Recall Door

Follow the steps below to set the Main Recall Door:

1. Navigate to **Main Menu | Setup | Fire | Main Recall | Opening**.
2. Enable or disable rear door as needed.
3. Scroll right and press **Save**.

## 26.2 Alternate Recall

If sensors detect fire at the designated main recall floor, the car will instead travel to a designated alternate recall floor.

### 26.2.1 Alternate Recall Floor

Follow the steps below to set the Alternate Recall Floor:

1. Navigate to **Main Menu | Setup | Fire | Alt Recall | Floor**.
2. Enter the alternate recall floor.
3. Scroll right and press **Save**.

### 26.2.2 Alternate Recall Door

Follow the steps below to set the Alternate Recall Door:

1. Navigate to **Main Menu | Setup | Fire | Alt Recall | Opening**.
2. Enable or disable rear door as needed.
3. Scroll right and press **Save**.

## 26.3 Main Smoke

Main Smoke refers to the scenario where the car is recalled to a designated landing due to smoke detection in the main lobby.

### 26.3.1 Main or Alternate

When smoke is detected, the car is recalled to the main landing. If the system is configured to check for smoke on that floor and smoke is present, the car travels to a designated alternate landing instead.

The following procedure outlines the conditions under which the car travels to either the main or alternate landing when smoke is detected:

1. Navigate to **Main Menu | Setup | Fire | Main Smoke Action | Main or Alt**.

2. Configure the alternate or main floor for the Main Smoke as needed.
3. Scroll right and press **Save**.

### 26.3.2 Flash Fire Hat

If the Flash Fire Hat feature is enabled during a Main Smoke event, a fire hat symbol on the panel will flash when smoke is detected.

Follow the steps below to enable the Flash Fire Hat.

1. Navigate to **Main Menu | Setup | Fire | Main Smoke Action | Flash Fire Hat**.
2. Set to **ON**.
3. Scroll right and press **Save**.

### 26.3.3 Shunt Trip

The Shunt Trip function is designed to activate a shunt output that trips a breaker, cutting off main power to the controller when smoke is detected in the main lobby.

The following procedure outlines how to configure the system parameters to respond appropriately to smoke detection in the main lobby:

1. Navigate to **Main Menu | Setup | Fire | Main Smoke Action | Shunt Trip**.
2. Set to **ON**.
3. Scroll right and press **Save**.

## 26.4 Alternate Smoke

Alternate Smoke refers to the scenario where the car is recalled to a designated alternate landing when smoke is detected in the main lobby.

### 26.4.1 Main or Alternate

When smoke is detected, the car initially travels to the main landing. If the system is configured to evaluate smoke presence on that floor and smoke is detected, the car then proceeds to the designated alternate landing.

The following procedure outlines the conditions under which the car travels to either the main or alternate landing when smoke is detected in the main lobby:

1. Navigate to **Main Menu | Setup | Fire | Alt Smoke Action | Main or Alt**.
2. Configure the alternate or main floor for the Main Smoke as needed.
3. Scroll right and press **Save**.

### 26.4.2 Flash Fire Hat

If the Flash Fire Hat feature is enabled during an Alternate Smoke event, a fire hat symbol on the panel will flash when smoke is detected.

Follow the steps below to enable the Flash Fire Hat:

1. Navigate to **Main Menu | Setup | Fire | Alt Smoke Action | Flash Fire Hat**.
2. Set to **ON**.
3. Scroll right and press **Save**.

### 26.4.3 Shunt Trip

The Shunt Trip function is designed to activate a shunt output that trips a breaker, cutting off main power to the controller when smoke is detected in the main lobby.

The following procedure outlines how to configure the system parameters to respond appropriately to smoke detection in the main lobby:

1. Navigate to **Main Menu | Setup | Fire | Alt Smoke Action | Shunt Trip**.
2. Set to **ON**.
3. Scroll right and press **Save**.

## 26.5 Hoistway Smoke

Hoistway Smoke refers to the scenario where the car is recalled to a designated landing when smoke is detected in the hoistway.

### 26.5.1 Main or Alternate

When smoke is detected in the hoistway, the car is recalled to the main landing. If the system is configured to evaluate smoke conditions on that floor and smoke is present, the car then travels to a designated alternate landing.

The following procedure outlines how the system determines whether the car travels to the main or alternate landing when Hoistway Smoke is detected:

1. Navigate to **Main Menu | Setup | Fire | Hoistway Smoke Action | Main or Alt**.
2. Configure the alternate or main floor for the Hoistway Smoke as needed.
3. Scroll right and press **Save**.

### 26.5.2 Flash Fire Hat

If the Flash Fire Hat feature is enabled during a Hoistway smoke event, a Fire Hat symbol on the panel will flash when smoke is detected.

Follow the steps below to enable the Flash Fire Hat:

1. Navigate to **Main Menu | Setup | Fire | Hoistway Smoke Action | Flash Fire Hat**.
2. Set to **ON**.
3. Scroll right and press **Save**.

### 26.5.3 Shunt Trip

The Shunt Trip function is designed to activate a shunt output that trips a breaker, cutting off main power to the controller when smoke is detected in the Hoistway.

The following procedure outlines how to configure the system parameters to respond appropriately to smoke detection in the Hoistway:

1. Navigate to **Main Menu | Setup | Fire | Hoistway Smoke Action | Shunt Trip**.
2. Set to **ON**.
3. Scroll right and press **Save**.

## 26.6 MR Smoke

MR Smoke refers to the condition where the car is recalled to a designated landing due to smoke detection in the Machine Room.

### 26.6.1 Main or Alternate

When smoke is detected in the Machine Room, the car is recalled to the main landing. If the system is configured to assess smoke on that floor and smoke is present, the car then travels to a designated alternate landing.

The following procedure outlines how the system determines whether the car travels to the main or alternate landing when Machine Room smoke is detected:

1. Navigate to **Main Menu | Setup | Fire | MR Smoke Action | Main or Alt**.
2. Configure the alternate or main floor for the MR Smoke as needed.
3. Scroll right and press **Save**.

### 26.6.2 Flash Fire Hat

If the Flash Fire Hat feature is enabled during a MR smoke event, a fire hat symbol on the panel will flash when smoke is detected.

Follow the steps below to enable the Flash Fire Hat:

1. Navigate to **Main Menu | Setup | Fire | MR Smoke Action | Flash Fire Hat**.
2. Set to **ON**.
3. Scroll right and press **Save**.

### 26.6.3 Shunt Trip

The Shunt Trip function is designed to activate a shunt output that trips a breaker, cutting off main power to the controller when smoke is detected in the Machine Room.

The following procedure outlines how to configure the system parameters to respond appropriately to smoke detection in the Machine Room:

1. Navigate to **Main Menu | Setup | Fire | MR Smoke Action | Shunt Trip**.
2. Set to **ON**.
3. Scroll right and press **Save**.

### 26.7 Recall Key

The Recall Key is used by fire service personnel to control the elevator during a fire emergency. It is typically located on the hall panel – usually in the main lobby – and inside the car. The key activates emergency landing operations as part of Fire Service Mode.

If the Flash Fire Hat feature is enabled, a Fire Hat symbol on the panel will flash when the recall key is used and smoke has been detected.

The following procedure outlines how to enable the Flash Fire Hat feature:

1. Navigate to **Main Menu | Setup | Fire | Recall Ket | Flash Fire Hat**.
2. Set to **ON**.
3. Scroll right and press **Save**.

### 26.8 Pit Smoke

Pit Smoke refers to the condition where the car is recalled to a designated landing when smoke is detected in the pit area.

#### 26.8.1 Main or Alternate

When smoke is detected in the pit, the car is recalled to the main landing. If the system is configured to evaluate smoke on that floor and smoke is present, the car travels to a designated alternate landing.

The following procedure outlines how the system determines whether the car travels to the main or alternate landing when pit smoke is detected:

1. Navigate to **Main Menu | Setup | Fire | PIT Smoke | Main or Alt**.
2. Configure the alternate or main floor for the PIT Smoke as needed.
3. Scroll right and press **Save**.

### 26.8.2 Flash Fire Hat

If the Flash Fire Hat feature is enabled during a PIT smoke event, a fire hat symbol on the panel will flash when smoke is detected.

Follow the steps below to enable the Flash Fire Hat:

1. Navigate to **Main Menu | Setup | Fire | PIT Smoke | Flash Fire Hat**.
2. Set to **ON**.
3. Scroll right and press **Save**.

### 26.8.3 Shunt Trip

The Shunt Trip function is designed to activate a shunt output that trips a breaker, cutting off main power to the controller in case of fire in the Machine Room.

The following procedure outlines how to configure the system parameters to respond appropriately to smoke detection in the pit:

1. Navigate to **Main Menu | Setup | Fire | PIT Smoke | Shunt Trip**.
2. Set to **ON**.
3. Scroll right and press **Save**.

## 26.9 Alt Machine Room

Alternate machine room parameters are configured when a group of elevators has a split machine room and hoistway layout.

### 26.9.1 Enable Alternate Machine Room

When secondary machine room operation is required, the Alternate Machine Room Smoke feature must be enabled.

The following procedure outlines how to enable alternate machine room smoke detection:

1. Navigate to **Main Menu | Setup | Fire | Alt. Machine Room | Enable Alt. MR**.
2. Set to **ON**.
3. Scroll right and press **Save**.

### 26.9.2 Hoistway 2 Smoke

When a group of elevators has a split hoistway configuration, the Hoistway 2 Smoke option must be enabled to support smoke detection in the secondary hoistway.

### 26.9.2.1 Main or Alternate

The following procedure outlines how to configure the system to determine whether the car travels to the main or alternate landing when Hoistway 2 smoke is detected:

1. Navigate to **Main Menu | Setup | Fire | Alt. Machine Room | HW 2 Smoke**.
2. Select **Main** or **Alt**.
3. Set to main or alternate recall landing.
4. Scroll right and press **Save**.

### 26.9.2.2 Flash Fire Hat

The following procedure outlines how to flash the Fire Hat when the Alternate Hoistway Smoke is triggered:

1. Navigate to **Main Menu | Setup | Fire | Alt. Machine Room | HW 2 Smoke | Flash Fire Hat**.
2. Set to **ON**.
3. Scroll right and press **Save**.

### 26.9.2.3 Shunt Trip

The Shunt Trip function is designed to activate a shunt output that trips a breaker, cutting off main power to the controller in case of a fire in the Machine Room.

The following procedure outlines how to configure the Shunt Trip function when Alternate Hoistway Smoke is triggered:

1. Navigate to **Main Menu | Setup | Fire | Alt. Machine Room | HW 2 Smoke | Shunt Trip**.
2. Set to **ON**.
3. Scroll right and press **Save**.

## 26.9.3 MR 2 Smoke

The MR 2 smoke is the smoke sensor located in the secondary machine room.

### 26.9.3.1 Main or Alt

The following procedure outlines how to configure the system to send the car to either the main or alternate landing when MR 2 Smoke is triggered:

1. Navigate to **Main Menu | Setup | Fire | Alt. Machine Room | MR 2 Smoke**.
2. Select **Main** or **Alt**.
3. Set to main or alternate recall landing.

4. Scroll right and press **Save**.

### 26.9.3.2 Flash Fire Hat

The following procedure outlines how to flash the Fire Hat when the Alternate Machine Room Smoke is triggered:

1. Navigate to **Main Menu | Setup | Fire | Alt. Machine Room | MR 2 Smoke | Flash Fire Hat**.
2. Set to **ON**.
3. Scroll right and press **Save**.

### 26.9.3.3 Shunt Trip

The Shunt Trip function is designed to activate a shunt output that trips a breaker, cutting off main power to the controller in case of a fire in the Machine Room.

The following procedure outlines how to configure the Shunt Trip function when Alternate Machine Room Smoke is triggered:

1. Navigate to **Main Menu | Setup | Fire | Alt. Machine Room | MR 2 Smoke | Shunt Trip**.
2. Set to **ON**.
3. Scroll right and press **Save**.

## 26.10 Advanced Configs

The Advanced Configuration menu provides a simplified way to configure specific fire service parameters within the system.

For detailed descriptions of each parameter, refer to the **Hydro:Evolved Parameter List**.

The following parameters can be enabled or disabled through the Advanced Configuration menu:

- FIRE RESET TO EXIT PHASE1
- DISA DR RESTRICTOR PHASE2
- FIRE PHASE2 SWING REOPEN DISA
- FIRE PHASE2 EXIT ONLY AT RECALL FLR
- FIRE IGNORE LOCKS JUMPED ON PHASE2
- FIRE OR IC STOP SWITCH KILLS DR ON FIRE MODES
- FIRE DOL TO EXIT PHASE2
- FIRE ALLOW RESET WITH ACTIVE SMOKE
- FIRE HAT FLASH IGNORE ORDER
- FIRE MOMENTARY DCB
- FIRE FLASH LOBBY LAMP
- FIRE REMOTE AND MAIN TO OVERRIDE SMOKE
- FIRE ENABLE PHE ON PHASE2
- FIRE DR OPEN ON HOLD
- DISA BYP IC STOP

- COURION FIRE1 ACTIVE
- EMS FIRE 1 ACTIVE
- BYP FIRESRV
- FIRE RECALL TO MAIN AFTER PHASE 2
- FIRE2 SWING REOPEN
- FIRE DISA LATCH SMOKES
- FIRE DISA LATCH LOBBY KEY
- FIRE DISA LATCH MAIN RECALL
- FIRE RESET ON TRANSITION
- FIRE EXIT PH2 WITHOUT PH1 RCL
- FIRE 2 ACTIVE ALWAYS ON DURING FP2
- CLOSE DOOR WHEN PHE BYPASSED ON FF2
- FIRE2 BYPASS ON MR AND HA SMOKE
- FIRE1 DOB HC ENABLED DWELL 1 MIN
- ONLY EXIT FP1 ON MAIN LANDING
- FIRE2 CANCEL BUTTON REOPEN DOOR
- FIRE2 CLOSE DOOR WHEN NO DOB
- FIRE SWITCH 2 POSITIONS
- FIRE NO DCL TO EXIT PHASE2
- FIRE1 RESET EXTINGUISHES LOBBY LAMP AT ALT FLOOR
- TURN OFF AT RECALL OUTPUT ON FP2
- ALLOW SHUNT TRIP ON INSPECTION MODE
- ALLOW SHUNT TRIP ON FIRE I ALTERNATE LANDING
- ALLOW SHUNT TRIP ON EMS

To configure parameters listed in Advanced Configuration:

1. Navigate to **Main Menu | Setup | Fire | Advanced Configuration**.
2. In the **Smoke Configuration** menu, scroll through the parameters.
  - The parameter name scrolls to the left automatically.
  - Select **ON** or **OFF** for the desired parameter.
3. Scroll right and press **Save**.

## 27 Flood

Flooding may occur due to natural disasters or other incidents, such as broken pipes. When a flood sensor detects water, an alarm is triggered and logged.

If the flood sensor is active, the elevator is limited to traveling to floors above the designated flood floor. If the car happens to be at/below the flood floor during a flood detection, the system will automatically move the car to the floor above the flood floor.

### 27.1 Number of Floors

When flooding is detected, the flood sensor switch sends a signal to notify the controller which floors to avoid during operation.

The following procedure describes how to set the number of floors the elevator is to avoid from the bottom landing:

1. Navigate to **Main Menu | Setup | Flood | Number of Floors**.
2. Set the floors to avoid.
  - For example, a value of 001 would cause the elevator to avoid the bottom landing.
3. Scroll right and press **Save**.

## 27.2 Okay to Run

The Okay to Run option allows the elevator to continue automatic operation above flooded floors.

The following procedure describes how to enable this option:

1. Navigate to **Main Menu | Setup | Flood | Okay to Run**.
2. Set to **ON** to continue running in Automatic operation.
3. Scroll right and press **Save**.

## 27.3 Override Fire

In certain emergencies, flooding operation may need to override fire operation.

The following procedure describes how to enable flood override on fire service:

1. Navigate to **Main Menu | Setup | Flood | Override Fire**.
2. Set to **ON**.
3. Scroll right and press **Save**.

## 28 Emergency Medical Service

Emergency Medical Service Phase 1 and Phase 2 services allow for elevator operation during medical emergencies.

- ◆ **EMS Phase 1:** Allows emergency medical personnel to make a hall call via key switch or button. The car bypasses all floors and travels directly to the designated landing. If Phase 2 is not initiated within the set Phase 1 Exit Delay time, the car returns to normal operation. Fire Phase 1 overrides EMS Phase 1.
- ◆ **MA EMS 1:** Enables a hall call to a predefined recall floor using the MA – EMS1 input. The recall floor can be set using parameter 08-0272 or through the user interface.
- ◆ **EMS Phase 2:** Allows medical personnel to hold doors open using a key switch, based on the Phase 2 Exit Delay setting, to safely remove a patient.

### 28.1 AllowPh2WithoutPh1

This setting allows EMS Phase 2 to be enabled directly without first enabling Phase 1.

**Procedure:**

1. Navigate to **Main Menu | Setup | EMS | Allowph2withoutph1**.
2. Scroll and select if the car is set to run in a medical emergency.
3. Scroll right and press **Save**.

**28.2 Exit Ph2 Any Floor**

This setting allows the car to exit EMS Phase 2 on any floor instead of only on the entry floor.

**Procedure:**

1. Navigate to **Main Menu | Setup | EMS | Exit Ph2 Any Floor**.
2. Scroll and select if the controller can exit phase 2 on any floor.
3. Scroll right and press **Save**.

**28.3 Fire Overrides Ph1**

This option allows fire operation to override EMS Phase 1 service.

**Procedure:**

1. Navigate to **Main Menu | Setup | EMS | Fire Overrides Ph1**.
2. Scroll and select if the fire overrides Phase 1 EMS operation.
3. Scroll right and press **Save**.

**28.4 Ph1 Exit Delay**

This parameter sets the time the car remains in EMS Phase 1 before returning to normal operation.

**Procedure:**

1. Navigate to **Main Menu | Setup | EMS | Ph1 Exit Delay**.
2. Set the time the car remains at a landing prior to normal operation.
3. Scroll right and press **Save**.

**28.5 Ph2 Exit Delay**

This sets the time the car remains in EMS Phase 2 before exiting the mode and closing the doors.

**Procedure:**

1. Navigate to **Main Menu | Setup | EMS | Ph2 Exit Delay**.

2. Set the delay time prior to the doors closing.
3. Scroll right and press **Save**.

## 28.6 Ph1 Recall Floor

This sets the recall floor for MA EMS 1 operation.

### Procedure:

1. Navigate to **Main Menu | Setup | EMS | Ph1 Recall Floor**.
2. Set the recall floor.
3. Scroll right and press **Save**.

## 29 Attendant

Attendant operation is an automatic mode in which a designated attendant manually controls the car's movement. Inside the car, UP and DOWN lamps indicate whether hall calls are latched above or below the current floor. The attendant uses these lamps along with UP and DOWN direction buttons to determine the next direction of travel, picking up and dropping off passengers accordingly.

When the elevator arrives at a landing, the car doors should be opened manually and must be manually closed by the attendant via the door open and door close buttons, respectively.

### 29.1 Dispatch Timeout

Each car is programmed to respond to a hall call within a specified time. If the car does not respond within that time, the call is reassigned to another car in the group.

Follow the steps below to set the Dispatch Timeout:

1. Navigate to **Main Menu | Setup | Attendant | Dispatch Timeout**.
2. Set the time for another car to take over the hall call.
3. Scroll right and press **Save**.

### 29.2 Buzzer Time

A buzzer may sound for a set duration after a hall call is placed to alert the attendant.

Follow the steps below to set the Buzzer Time:

1. Navigate to **Main Menu | Setup | Attendant | Buzzer Time**.
2. Set the duration for which the buzzer rings after a hall call is made.
3. Scroll right and press **Save**.

### 30 Car Call Sequential Step Scanning

Elevator Car Call Sequential Step Scanning is a floor selection feature designed to improve accessibility.

This function enables users to select a destination floor using only two buttons – Up Scan and Down Scan. Instead of pressing a specific floor number, users navigate through available floors sequentially in the desired direction.

The scan buttons are located adjacent to or immediately above the emergency control panel, ensuring convenient reach for users with limited mobility.

This scanning system ensures that passengers with mobility impairments can independently and confidently operate the elevator's car call interface without needing assistance.

Floor selection is managed through these main interface elements:

- **Up Scan Button:** Scrolls through floors above the current floor.
- **Down Scan Button:** Scrolls through floors below the current floor.
- **Car Call Button Lamps:** Used as cursors to indicate the currently selected floor.

When a scan button is pressed:

1. Scanning starts from the current floor.
2. The CCB lamp for the current floor flashes to indicate that it is under selection.
3. If the button remains pressed:
  - The system automatically advances to the next floor, moving upward or downward depending on which button is held.
  - The lamp corresponding to each new floor flashes as it becomes the active selection.
4. If the Up or Down Scan button is released and not pressed again for 2 seconds, the current flashing floor is registered as a car call, only if:
  - The elevator has access to that floor (e.g., the door can open), and
  - The floor is not secured or restricted. If the selected floor is inaccessible or secured, the car call will not be registered, even if the 2-second timeout condition is met.

### 31 Independent Service

In Independent Service mode, the selected elevator car is removed from the group and operates independently. It no longer responds to group Hall Calls or normal dispatching logic. Instead, it follows its own call system, free from the group's optimization routines. Independent Service mode is activated through an input.

### 32 Battery Power

In Battery Rescue mode, the system responds to a power failure by safely lowering the car to the bottom landing at leveling speed. Once there, passengers can exit the car safely.

### 33 Emergency Recall

In Emergency Recall mode, the control system bypasses all Car and Hall Calls, automatically sending the car(s) to a designated recall landing. The doors open and remain open.

- ◆ **Manual Activation:** Through the local monitoring system, users may select a desired recall landing or use the default recall landing.
- ◆ **Automatic Activation:** Through virtual inputs, the car(s) travel automatically to the default recall landing.

The default recall landing is the designated alternate recall floor.

### 34 Low Pressure

In Low Pressure mode:

- If the car is moving, it stops and enters a fault state.
- If the car is idle, it remains faulted without moving.
- If stopped within the door zone, passengers may open the doors using the Door Open button.

Low Pressure mode is activated through an input.

### 35 Motor Overheat

In Motor Overheat mode, the car automatically recalls to the bottom landing. The doors open to allow passengers to exit safely.

Motor Overheat mode is activated through an input.

### 36 Phase Fault

In Phase Fault mode, the detection of a phase fault causes the car to recall automatically to the lowest landing. Once there, the doors open to release passengers.

### 37 Terminal Express

In Terminal Express mode, the car only accepts Hall and Car Calls from designated terminal floors.

**Example:** In a 10-floor building, the car may be configured to respond exclusively to calls from floors 2 and 8.

---

# INPUTS & OUTPUTS

---

## 1 Assigning Inputs and Outputs

Like previous Smartrise controllers, the Hydro:Evolved retains the ability to change, add, remove, or relocate inputs and outputs, provided they are not fixed (i.e., inputs/outputs that cannot be altered due to safety constraints). Any unused input or output can be assigned a feature if additional functionality is required or if there is a need to reassign an input or output.

**Inputs** can only be assigned to the **500** series, and **outputs** to the **600** series. Therefore, if an output is searched for and incorrectly attempted to be assigned to a 500-series slot, the feature will not be found.

## 2 Adding an Input or Output

Follow the steps below to add an input or an output:

1. Navigate to **Main Menu | Setup | Setup I/O | Setup Inputs** or **Setup Outputs**.
2. From the **Select Board** menu, choose the board to which the input or output will be assigned.
3. Use the **Up** button to scroll until an unused input or output is displayed.

**NOTE:** The example below uses an input.

The unused **Input/Output** screen shows:

- The second and third lines as **unused**.
- The top line displays the current input/output number.
- In the example below, 503 indicates the currently selected input and 508 indicates the total number of inputs available on the board.



Figure 66: Unused Input / Output

4. Scroll one step to the right.
5. Scroll through and select the desired category for the input or output.

**NOTE:** The category appears on the second line.

6. Scroll another step to the right.
7. Scroll through and select the desired feature to assign. The example below shows selecting **Car to Lobby** under the **Auto Operation** category for an unused input.



Figure 67: Category and Input Example

8. Scroll right and press **Save**.

### 3 Removing an Input or Output

Follow the steps below to remove an input or output:

1. Navigate to **Main Menu | Setup | Setup I/O | Setup Inputs** or **Setup Outputs**.
2. From the **Select Board** menu, choose the board to which the input or output will be assigned.
3. Scroll to select the input or output to be removed.
4. Scroll one step to the right.
5. Scroll and set the current input or output to **unused**.
6. Scroll another step to the right.
7. Scroll and set the associated category to **unused**.
8. Scroll right and press **Save**.

### 4 Types of Inputs

The tables below define the types of inputs by category.

Table 15: Auto Operation Inputs

Input	Description
<b>Active Shooter</b>	Places all cars in a group into Active Shooter Mode (must be programmed to a shared group input on each car).
<b>Attd Byp</b>	When active, attendant operation causes the car to skip past all hall calls between its current position and current destination.
<b>Attd Down</b>	Sets the next direction the car will try to move when doors are closed on attendant operation.
<b>Attd On</b>	Puts the car on attendant operation.
<b>Attd Up</b>	Sets the next direction the car will try to move when doors are closed on attendant operation.
<b>Buffered HC</b>	Activation of Buffered HC dispatch logic.
<b>Bypass Wanderguard Next CC</b>	Bypasses Wanderguard from inside the car for the next car call only.
<b>Bypass Wanderguard Next CC</b>	Bypasses Wanderguard from inside the car for the next car call only.
<b>Car To Lobby</b>	Captures car and sends it to the lobby where it will hold doors open.
<b>Clear Latched Calls</b>	Clears all latched calls.

Input	Description
<b>Custom Operation</b>	Puts car on custom operation mode.
<b>DISA All HC</b>	Disables all hall calls on the car when active.
<b>DISA Pass Chime</b>	Disables passing chime when active.
<b>Distress Ack</b>	At a central control console, a distress and light buzzer is provided for each elevator and an acknowledge button common to all elevators. Pressing the distress alarm button, triggering the emergency stop switch, if a dispatched car remains at a landing for >30 seconds, or if the electrical safety circuit is open, will turn on the distress light and pulse the distress buzzer. The Distress light will remain lit until the acknowledge button is pressed.
<b>Distress BTN</b>	At a central control console, a distress and light buzzer is provided for each elevator and an acknowledge button common to all elevators. Pressing the distress alarm button, triggering the emergency stop switch, if a dispatched car remains at a landing for >30 seconds, or if the electrical safety circuit is open, will turn on the distress light and pulse the distress buzzer. The Distress light will remain lit until the acknowledge button is pressed.
<b>EMS2 On</b>	Holds car on EMS Phase 2 operation after activation of EMS Phase 1 operation.
<b>ENA Down Peak</b>	Causes the car to park at the top floor when idle.
<b>ENA Lobby Peak</b>	Causes the car to park at the lobby floor when idle.
<b>ENA Up Peak</b>	Causes the car to park at the bottom floor when idle.
<b>Enable All CC</b>	Bypasses car call security on all floors.
<b>Enable All CC F</b>	Enables all car call front buttons, bypassing car call security on all front car call buttons.
<b>Enable All CC R</b>	Enables all car call rear buttons, bypassing car call security on all rear car call buttons.
<b>Enable All HC</b>	Bypasses hall call security on all landings. When timed hall call security is enabled via the UI, activation of the Enable All HC input does not override it. This input is only effective in bypassing timed hall call security if the feature was activated through the Enable HC Timed Security input.
<b>Enable HC Timed Security</b>	Activation will enable the HC timed security.
<b>Enable Swing</b>	Puts car on swing operation, removing the car from regular group calls and allowing it to take swing hall calls.
<b>Ignore All CC Front</b>	Ignoring of all car calls front.
<b>Indep Srv</b>	Puts car on independent service operation.
<b>MA EMS1</b>	Activation of EMS1 service via key switch.
<b>Marshal Mode</b>	Puts the car on marshal mode operation.
<b>Override Group Hall Mask</b>	Overrides the Hall call group mask by a car specific hall mask.
<b>Parking Off</b>	Disables parking.
<b>Sabbath</b>	Puts car on Sabbath operation where car will automatically move to configured floors and cycle doors, without user intervention.
<b>Single Automation Push Button</b>	Activation of Single Automatic Push Button (SAPB) feature.
<b>Terminal Express</b>	Activation of terminal express mode of operation
<b>Wander Guard</b>	Puts the car on wander guard operation.

Table 16: Car Call (Front and Rear) Inputs

Input	Description
Buttons 1-96	Front car call buttons.
Buttons 1-96	Rear car call buttons.

Table 17: Car Call Enable (Front and Rear) Inputs

Input	Description
Keys 1-96	Input that is required to be activated whenever there is a front car call to a secured floor.
Keys 1-96	Input that is required to be activated whenever there is a rear car call to a secured floor.

Table 18: Controller Inputs

Input	Description
Battery Fault	When active, car will assert a battery fault (F656).
Battery Power	Puts the car on battery rescue operation.
Delta	Feedback input from the Delta relay which picks the Run Contactor in a Wye Delta starter configuration.
DNH Valve Mon	Monitoring of safety relay for cutting the down high valve 's neutral side. If the input is high, the valve's neutral side is disconnected. Only checked if programmed.
Emergency Stop	When active, it halts the car, and activates a lamp indicator "Car Stopped Lamp".
Fan And Light	When active, causes the output LIGHT FAN to also activate.
Fault	Generic fault that will stop the car with F713.
Inching Down	Moves car down when inching operation is enabled. Activated by constant pressure.
Inching Enable	Enables Inching operation, which is a special mode of operation permitting the car to move within DZ while doors are open.
Inching Safe	Safety input enables up/down movement on inching operation
Inching Up	Moves car up when inching operation is enabled. Activated by constant pressure.
Insp Valve Mon	Monitoring of safety relay for cutting the inspection valve 's neutral side. If the input is high, the valve's neutral side is disconnected. Only checked if programmed.
OOS	Puts the car in out of service operation.
Phase Flt	Line monitoring hardware has detected voltage lines are out of phase or missing. Only checked if programmed.
SS Flt	Primary soft starter signaling a generic fault. Only checked if programmed.
SS2 Flt	Secondary soft starter signaling a generic fault. Only checked if programmed.
SS3 Fault	Third soft starter signaling a generic fault. Only checked if programmed.
Start OVLD	Feedback input from the contactor starter overload relay. Used for jobs with a contactor starter.
UPH Valve Mon	Monitoring of safety relay for cutting the up high valve 's neutral side. If the input is high, the valve's neutral side is disconnected. Only checked if programmed.

<b>Valve FIt</b>	Valve controller generic fault.
------------------	---------------------------------

Table 19: Emergency Power Inputs

<b>Input</b>	<b>Description</b>
<b>AutoSelect</b>	After all cars have completed their recall, a preconfigured number of cars are released to go back to automatic operation. These cars are auto selected.
<b>EP On</b>	Car is moving from generator power back to main line power, cars should stop at their nearest reachable landings and hold doors open.
<b>Pretransfer</b>	Car is moving from generator Description back to main line power. Cars should stop at their nearest reachable landings and hold doors open.
<b>Select1</b>	After all cars have completed their recall, a preconfigured number of cars are released to go back in to automatic operation. These cars are manually selected via the select inputs if Auto Select is inactive.
<b>Select2</b>	After all cars have completed their recall, a preconfigured number of cars are released to go back in to automatic operation. These cars are manually selected via the select inputs if Auto Select is inactive.
<b>Select3</b>	After all cars have completed their recall, a preconfigured number of cars are released to go back in to automatic operation. These cars are manually selected via the select inputs if Auto Select is inactive.
<b>Select4</b>	After all cars have completed their recall, a preconfigured number of cars are released to go back in to automatic operation. These cars are manually selected via the select inputs if Auto Select is inactive.
<b>Select5</b>	After all cars have completed their recall, a preconfigured number of cars are released to go back in to automatic operation. These cars are manually selected via the select inputs if Auto Select is inactive.
<b>Select6</b>	After all cars have completed their recall, a preconfigured number of cars are released to go back in to automatic operation. These cars are manually selected via the select inputs if Auto Select is inactive.
<b>Select7</b>	After all cars have completed their recall, a preconfigured number of cars are released to go back in to automatic operation. These cars are manually selected via the select inputs if Auto Select is inactive.
<b>Select8</b>	After all cars have completed their recall, a preconfigured number of cars are released to go back in to automatic operation. These cars are manually selected via the select inputs if Auto Select is inactive.
<b>UpToSpeed</b>	Car is on generator power. Generator has spun up and cars can begin recalling one at a time to the lobby where they will hold doors open.

Table 20: Fire/Earthquake Inputs

<b>Input</b>	<b>Description</b>
<b>EQ Hoistway Scan</b>	Initiates the hoistway scan for earthquake at low speed.
<b>Fire Recall Off</b>	Car is being commanded to go on fire phase 1 recall via the main keyswitch. Fire Recall Rst activation takes priority of this status.
<b>Fire Recall Rst</b>	Car is commanded to exit Fire Phase 1 recall via the main keyswitch.
<b>Fire2 Cncl</b>	In car Fire Phase 2 cancel keyswitch is ON. The car will cancel its current destination and not take calls until the input is deactivated.
<b>Fire2 Hold</b>	In car Fire Phase 2 keyswitch is in the HOLD position.
<b>Fire2 Off</b>	In car Fire Phase 2 keyswitch is in the OFF position.

Input	Description
Fire2 On	In car Fire Phase 2 keyswitch is in the ON position.
Mashal Fire Ovl	When active, in the “Secure” position, all “Fireman’s Recall” devices for the elevator shall be deactivated.
Remote Fire Key	Car is being commanded to go on Fire Phase 1 recall via a remote keyswitch. Only checked when programmed.
Seismic	Seismic activity detected, puts car on Seismic Mode of operation.
Shunt Trip Intent	When active, the shunt trip recall mode of operation is activated
Smoke Alt	Alternate recall floor smoke detector indicating fire is detected.
Smoke HA	Hoistway smoke sensor indicating fire is detected.
Smoke HA 2	Secondary hoistway smoke sensor indicating fire is detected. Used for a jobsite where the group is split between two machine rooms.
Smoke Main	Main recall floor smoke detector indicating fire is detected.
Smoke MR	Machine room smoke detector indicating fire is detected.
Smoke MR 2	Secondary machine room smoke detector indicating fire is detected. Used for a jobsite where the group is split between two machine rooms.
Smoke Pit	Pit smoke sensor indicating fire is detected. Not checked if not programmed.

Table 21: Front Doors Inputs

Input	Description
BCL	Indicates that the manual hall doors for the bottom floor front opening are closed.
DCB	Door close button, requests that the front door closes.
DCL	Car door, door close limit input indicating that the front door is closed.
DOB	Door open button, requests that the front door opens.
DOL	Car door, door open limit input indicating the front door is open.
DPM	Car door position monitor input indicating front door is closed. Checked only if programmed.
Front Doors Gateswitch	Car door gateswitch contact indicating front door is closed.
Front Doors Zone	Car door door zone input indicating the front door can open.
HOLD	Door hold button, requests that the front door opens and remains open for a longer than usual dwell period.
Marshl DCB	For Marshal Mode Only DCB Front for remote console.
Marshl DOB	For Marshal Mode Only DOB Front for remote console.
MCL	Indicates that the manual hall doors for all the middle floors front openings are closed.
PHE	Car door photoeye input indicating that the front door light curtain is obstructed and doors are not permitted to close.
PHE ALT	Alternate photoeye input logically AND’ed with the primary photoeye. Photoeye is active if either signal is low. Used with Peelle light curtain.
Safety Edge	Indicates that the safety edge is obstructed and doors are not permitted to close. For freight doors only.
TCL	Indicates that the manual hall doors for the top floor front opening are closed.

Table 22: Inspection Inputs

Input	Description
CT DN	Moves the car down when activated with the INSP__CT_EN input also active and on car top inspection mode.
CT Enable	Enables the INSP__CT_UP and INSP__CT_DN inputs.
CT UP	Moves the car up when activated with the INSP__CT_EN input also active and on car top inspection mode.
IC DN	Moves the car down when on in car inspection mode.
IC UP	Moves the car up when on in car inspection mode.
IL Down	Moves the car down when on in car inspection mode.
IL Up	Moves the car up when on landing inspection mode.
IP Down	Moves the car down when on pit inspection mode.
IP Up	Moves the car up when on pit inspection mode.
Landing Inspection Operation	When MR SRU DIP B3 is ON, parameter Enable_Landing_Inspection (01-38) is ON, and 502 is activated, this input puts the car on Landing inspection operation. <b>NOTE:</b> 502 is normally closed; to activate the input, disconnect 24 V.
Pit Inspection Operation	When MR SRU DIP B4 is ON, parameter Enable_Pit_Inspection (01-37) is ON, and 501 is activated, this input puts the car on Pit inspection operation. <b>NOTE:</b> 501 is normally closed; to activate the input, disconnect 24 V.

Table 23: Rear Doors Inputs

Input	Description
BCL	Indicates that the manual hall doors for the bottom floor rear opening are closed.
DCB	Door close button, requests that the rear door closes.
DCL	Car door, door close limit input indicating that the rear door is closed.
DOB	Door open button, requests that the rear door opens.
DOL	Car door, door open limit input indicating the rear door is open.
DPM	Car door position monitor input indicating rear door is closed. Checked only if programmed.
HOLD	Door hold button, requests that the rear door opens and remains open for a longer than usual dwell period.
Marshl DCB	For Marshal Mode Only DCB Rear for remote console.
Marshl DOB	For Marshal Mode Only DOB Rear for remote console.
MCL	Indicates that the manual hall doors for all the middle floors rear openings are closed.
PHE	Car door photoeye input indicating that the rear door light curtain is obstructed and doors are not permitted to close.
PHE ALT	Alternate photoeye input logically AND'ed with the primary photoeye. Photoeye is active if either signal is low. Used with Peelle light curtain.
Rear Doors Door Zone	Car door door zone input indicating the rear door can open.
Rear Doors Gateswitch	Car door gateswitch contact indicating rear door is closed.
Safety Edge	Indicates that the safety edge is obstructed and doors are not permitted to close. For freight doors only.
TCL	Indicates that the manual hall doors for the top floor rear opening are closed.

Table 24: Safety Inputs

Input	Description
Clear Warning Light	When active, it clears warning light
Collapsible Fully Extended	Collapsible fully extended input for CT inspection.
Collapsible Fully Stowed	Collapsible fully stowed input for CT inspection.
Enable Tfl2	Bypass TFL when on CT-inspection mode
Flood	Puts car on flood operation.
Flood Reset	Resets flood operation when programmed.
Glass Window Switch	Glass window switch input.
Low Oil	N/C input signals low oil.
Low PRESS	N/C input signals low pressure.
Motor OVHT	N/C input signals motor overheat.
Oil Overheat	N/C input signals High temp oil.
Phone Failure	Indicates if in car emergency phone has failed. A17-2013, 2.27.1.1.6
Phone Reset	Resets the emergency phone failure buzzer. A17-2013, 2.27.1.1.6
Pressure Switch	Pressure switch input.
Rupture Switch	Rupture switch input.
Tfl2	Top Final Limit 2 input.
Viscosity	N/C input signals cold oil.

## 5 Types of Outputs

The tables below define the types of outputs by category.

Table 25: Auto Operation Outputs

Output	Description
Accelerating	Activates when the car is in the acceleration stage of its run.
Active Shooter	Output activated whenever the "Active shooter" mode input is on.
Arrival DN 1	Discrete arrival lantern output, set 1. See 08-197 and 01-175.
Arrival DN 2	Discrete arrival lantern output, set 2. See 08-198 and 01-176.
Arrival DN 3	Discrete arrival lantern output, set 1. See 08-199 and 01-177.
Arrival DN 4	Discrete arrival lantern output, set 2. See 08-200 and 01-178.
Arrival DN 5	Discrete arrival lantern output, set 2. See 08-201 and 01-179.
Arrival UP 1	Discrete arrival lantern output, set 1. See 08-197 and 01-175.
Arrival UP 2	Discrete arrival lantern output, set 2. See 08-198 and 01-176.
Arrival UP 3	Discrete arrival lantern output, set 1. See 08-199 and 01-177.
Arrival UP 4	Discrete arrival lantern output, set 2. See 08-200 and 01-178.
Arrival UP 5	Discrete arrival lantern output, set 2. See 08-201 and 01-179.
At Landing Lamp	Output indicates car is at landing and idle in automatic normal mode.
Auto Mode Generic Output	Output indicated the mode of operation index saved in 08-0016.
Buzzer	Triggers an audible in car buzzer when the car is overloaded, on fire, nudging, on EMS Phase 1, or when on Attendant and there is a demand.
Car To Lobby	This output activates if the car has finished its recall triggered by the car to lobby input.
CC Acknowledge	Activates when a car call is placed. This is used in Canada for blind people.

Output	Description
<b>Chime</b>	Activates when the car is in an automatic mode of operation and the passing chime disable Output is inactive. The chime is triggered for 500ms every time the car's PI changes.
<b>Decelerating</b>	Activates when the car is in the deceleration stage of its run.
<b>Distress Buzzer</b>	At a central control console, a distress and light buzzer will be provided for each elevator and an acknowledge button common to all elevators. Pressing the distress alarm button, triggering the emergency stop switch, if a dispatched car remains at a landing for >30 seconds, or if the electrical safety circuit is open will turn on the distress light, and pulse the distress buzzer. The Distress light will remain lit until the acknowledge button is pressed.
<b>Distress Lamp</b>	At a central control console, a distress and light buzzer will be provided for each elevator and an acknowledge button common to all elevators. Pressing the distress alarm button, triggering the emergency stop switch, if a dispatched car remains at a landing for >30 seconds, or if the electrical safety circuit is open will turn on the distress light, and pulse the distress buzzer. The Distress light will remain lit until the acknowledge button is pressed.
<b>Group Redundancy</b>	Switches power to a redundant set of Riser boards.
<b>In Service</b>	Activates if hall calls are not disabled and the car is not faulted.
<b>In Use</b>	Activates when the car is not in normal operation, is in motion, or has its doors open.
<b>Lamp At Recall</b>	Activates when the car has completed EMS, Fire, or emergency power recall.
<b>Lamp Attd Above</b>	Activates when the car is in attendant operation and there is a hall call at a floor above.
<b>Lamp Attd Below</b>	Activates when the car is in attendant operation and there is a hall call at a floor below.
<b>Lamp EMS</b>	Activates when the car is in EMS Phase 1 or Phase 2.
<b>Lamp Indp Srv</b>	Activates when the car is in independent service operation.
<b>Lamp Parking</b>	Triggers when the car is in normal operation and is parked.
<b>Lamp Sabbath</b>	Activates when the car is in Sabbath operation.
<b>Near Capacity Lamp</b>	Output activated when full load input is activated.
<b>Travel Dn</b>	Triggers when the car is moving down.
<b>Travel Up</b>	Triggers when the car is moving up.
<b>VIP Mode</b>	This output is activated when car is on VIP mode of operation.

Table 26: Car Call (Front and Rear) Outputs

Output	Description
<b>Lamp 1-96</b>	Front car call lamps.
<b>Lamp 1-96</b>	Rear car call lamps.

Table 27: Controller Outputs

Output	Description
<b>Battery Pwr</b>	Output signaling car is on battery power.
<b>Car Stopped Lamp</b>	Output indicates that Emergency Stop switch was activated.

<b>CEDES Fan</b>	CEDES Maintenance Fan output. Blows air at Cedes tape when in motion to clear accumulated dust.
<b>Delta</b>	Output to the Delta relay which picks the Run Contactor in a Wye Delta starter configuration.
<b>Fault Lamp</b>	Output indicates when the car is in a faulted state.
<b>Hoistway Lamp</b>	Output indicates car in hoistway/access/inspection mode or fire phase 2 mode.
<b>Light Fan</b>	Turns on car light and fan hardware.
<b>MR Fan</b>	Fan output that will remain active for an adjustable period of time after each run.
<b>SS Reset</b>	Output to the cycle power to a faulted soft starter.
<b>Start Motor</b>	Output to start pump motor.
<b>Start Motor 2</b>	Output to start pump motor (secondary soft starter).
<b>Valve High Down</b>	Output to trigger the high speed valve in the down direction.
<b>Valve High Up</b>	Output to trigger the high speed valve in the up direction.
<b>Valve Insp</b>	Output to signal to blaine valve controller that the car is attempting an inspection run.
<b>Valve Level Down</b>	Output to trigger the leveling speed valve in the down direction. For V2 this the the DNL valve.
<b>Valve Level Up</b>	Output to trigger the leveling speed valve in the up direction. For V2 this is the UPL valve.
<b>Valve Low Down</b>	Output to trigger the low speed valve in the down direction. This is not the DNL valve for V2, that is marked CTRL__VALVE_LEVEL_DOWN valve for C4.
<b>Valve Low Up</b>	Output to trigger the low speed valve in the up direction. This is not the UPL valve for V2, that is marked CTRL__VALVE_LEVEL_UP valve for C4.
<b>Valve Mid Down</b>	Output to trigger the medium speed valve in the down direction.
<b>Valve Mid Up</b>	Output to trigger the medium speed valve in the up direction.

Table 28: Emergency Power Outputs

<b>Output</b>	<b>Description</b>
<b>Lamp On EP</b>	Car is on emergency power operation.
<b>Select 1</b>	Car is on emergency power operation and is recalling or has been released back into automatic operation.
<b>Select 2</b>	Car is on emergency power operation and is recalling or has been released back into automatic operation.
<b>Select 3</b>	Car is on emergency power operation and is recalling or has been released back into automatic operation.
<b>Select 4</b>	Car is on emergency power operation and is recalling or has been released back into automatic operation.
<b>Select 5</b>	Car is on emergency power operation and is recalling or has been released back into automatic operation.
<b>Select 6</b>	Car is on emergency power operation and is recalling or has been released back into automatic operation.
<b>Select 7</b>	Car is on emergency power operation and is recalling or has been released back into automatic operation.
<b>Select 8</b>	Car is on emergency power operation and is recalling or has been released back into automatic operation.

Table 29: Fire/Earthquake Outputs

Output	Description
<b>EQ Slow Lamp</b>	Activates when the car is in EQ Hoistway Scan operation.
<b>Fire I Active</b>	Used by Peelle door operator. Active if Fire Phase 1 is active and recall has not completed.
<b>Fire I Hold</b>	Activates when the car has arrived at the fire recall floor and is on Fire Phase 1.
<b>Fire II Active</b>	Used by Peelle door operator. Active if Fire Phase 2 is active.
<b>Fire II Hold</b>	Used by Peelle door operator. Active if on Fire Phase 2 hold operation.
<b>Fire Shunt</b>	Activates when the car is on fire service and has completed its recall.
<b>Lamp EQ</b>	Turns on when the car is on seismic or counterweight derail modes of operation.
<b>Lamp Fire</b>	Activates when the car is in fire service operation. Depending on the configuration, it will either flash every 500 ms or stay ON the whole time.
<b>Lamp Fire Lobby</b>	Activates when the car is in fire service operation. Depending on the configuration it will either flash every 500 ms or stay ON the whole time.
<b>Lamp Seismic Status</b>	Activates when the car is on Seismic.

Table 30: Front Doors Outputs

Output	Description
<b>Arrival Down</b>	Arrival down turns on when the car arrives at a floor then opens its doors and intends to continue moving down.
<b>Arrival Up</b>	Arrival up turns on when the car arrives at a floor then opens its doors and intends to continue moving up.
<b>CAM</b>	Retiring CAM. For swing hall doors and some freight doors, this output controls the hall locks. This output turns on when the car is in motion.
<b>DC</b>	Door close.
<b>DCL</b>	Door closed limit status. This output turns ON when the door closed limit switch signals the door is closed.
<b>DCM</b>	Used by Peelle door operator. Triggers door operator fast open/close where landing and car door movement will occur simultaneously.
<b>DCP</b>	Door close protection.
<b>DO</b>	Door open.
<b>DOL</b>	Door open limit status. This output turns ON when the door open limit switch signals the door is open.
<b>Gate Release</b>	Gate release.
<b>Hold Lamp</b>	Door hold.
<b>NDG</b>	Door nudge. After a specified timeout, if the door has not closed, the doors will move to a nudging state where the PHE is ignored and the nudging output will turn on.
<b>Restrictor</b>	Door restrictor.
<b>Safety Edge</b>	Safety edge broken status. This output turns ON when the safety edge or photoeye is broken.
<b>Test</b>	Used by Peelle light curtain to test for photoeye failure prior to each close attempt.
<b>Warning Buzzer</b>	Used by Peelle door operator. Activates 5 seconds before starting door close and remains on until doors fully closed.

Table 31: Inspection Output

Output	Description
Lamp Insp	Signals when the car is on inspection.

Table 32: Rear Doors Outputs

Output	Description
Arrival Down	Arrival down turns on when the car arrives at a floor then opens its doors and intends to continue moving down.
Arrival Up	Arrival up turns on when the car arrives at a floor then opens its doors and intends to continue moving up.
CAM	Retiring CAM. For swing hall doors and some freight doors, this output controls the hall locks. This output turns on when the car is in motion.
DC	Door close.
DCL	Door closed limit status. This output turns ON when the door closed limit switch signals the door is closed.
DCM	Used by Peelle door operator. Triggers door operator fast open/close where landing and car door movement will occur simultaneously.
DCP	Door close protection.
DO	Door open.
DOL	Door open limit status. This output turns ON when the door open limit switch signals the door is open.
Gate Release	Gate release.
Hold Lamp	Door hold.
NDG	Door nudge. After a specified timeout, if the door has not closed, the doors will move to a nudging state where the PHE is ignored and the nudging output will turn on.
Restrictor	Door restrictor.
Safety Edge	Safety edge broken status. This output turns ON when the safety edge or photoeye is broken.
Test	Used by Peelle light curtain to test for photoeye failure prior to each close attempt.
Warning Buzzer	Used by Peelle door operator. Activates 5 seconds before starting door close and remains on until doors fully closed.

Table 33: Safety Outputs

Output	Description
Lamp Flood	Car's flood sensor has detected a flood.
Phone Fail Lamp	Lamp indicating emergency phone has failed. A17-2013, 2.27.1.1.6
Phone Fail Buzzer	Buzzer indicating emergency phone has failed. A17-2013, 2.27.1.1.6
Warning Light	Output activated when an unauthorized car call is detected

## 6 Invert Inputs

After assigning an input type, the system may need to monitor the input state as either active or inactive. Invert Inputs allows changing how the system interprets the assigned input logic level.

Follow the steps below to change the state of an input:

1. Navigate to **Main Menu | Setup | Setup I/O | Invert Inputs**.
2. From the **Select Board** menu, scroll and select the board containing the input to be inverted.
3. In the **Invert Inputs** menu, scroll and select the assigned input.
4. Set the state to **Active (On)** or **Inactive (Off)**.
5. Scroll right and press **Save**.

## 7 Invert Outputs

Invert Outputs functions similarly to Invert Inputs, but for output signals. After assigning an output type, the system may require inversion of the logic level to match system requirements.

Follow the steps below to change the state of an output:

1. Navigate to **Main Menu | Setup | Setup I/O | Invert Outputs**.
2. From the **Select Board** menu, scroll and select the board containing the input to be inverted.
3. In the **Invert Inputs** menu, scroll and select the assigned input.
4. Set the state to **Active (On)** or **Inactive (Off)**.
5. Scroll right and press **Save**.

---

# **CONTROLLER HARDWARE**

---

## 1 Controller Hardware Overview

The Hydro:Evolved controller consists of the following boards:

- MR board - SR3032
- Smartrise Universal (SRU) board - SR3030
- I/O board (Riser board) - SR 3031
- 24 Input board – SR3041
- Hall board - SR1060
- Valve board - SR3045

## 2 MR Board (SR3032)

The MR Board serves as the main interface within the controller. It features two sets of DIP switch banks:

- **Bank A** (upper bank)
- **Bank B** (lower bank)

Each DIP switch is configured to enable a specific functionality. The table below outlines the functions and descriptions of the switches in Bank A.

Table 34: MR Board SR3032 Bank A DIP Switch Setting Configuration

DIP Switch	Functionality	Description
DIP 1	CPU Stop Switch	Halts parameters updates and used to reset some latched faults.
DIP 2	N/A	N/A
DIP 3	Capture Car/Disable Doors	Takes the car out of the group and completes all Car Calls before going into captured mode.
DIP 4	Enable GUI Edit (v1.02.54 and above)	Allows to Edit the parameters from GUI (including the restore param process).
DIP 5	Learn Mode	Activates Learn Mode on the controller to learn the hoistway.
DIP 6	NA	NA
DIP 7	Pop-up Blocker	Disables the fault pop-up messages. Faults can still be viewed in the active and logged faults.
DIP 8	Bootloader Flag	Sets all boards in software download mode to update the firmware

The table below outlines the functions and descriptions of the switches in Bank B.

Table 35: MR Board SR3032 Bank B DIP Switch Setting Configuration

DIP Switch	Functionality	Description
DIP 1	Invert NTS Output	When set to ON, NTS output is Active Low.
DIP 2	Rear Doors	Must be set if rear doors are present.
DIP 3	Enable Landing Insp	Must be set if Landing Inspection operation is used.
DIP 4	Enable Pit Insp	Must be set if Pit Inspection operation is used.
DIP 5	Sync Params	Writes parameters from cartop to machine room. This switch is used when replacing the MR board.
DIP 6	Bypass Fire Srv (w/ 01-0131)	Setting this along with parameter 01-0131 to ON bypasses fire service.
DIP 7	Preflight Check	It ensures the safety and proper functioning of the elevator. It involves checking mechanical, electrical, and safety components.
DIP 8	NA	NA

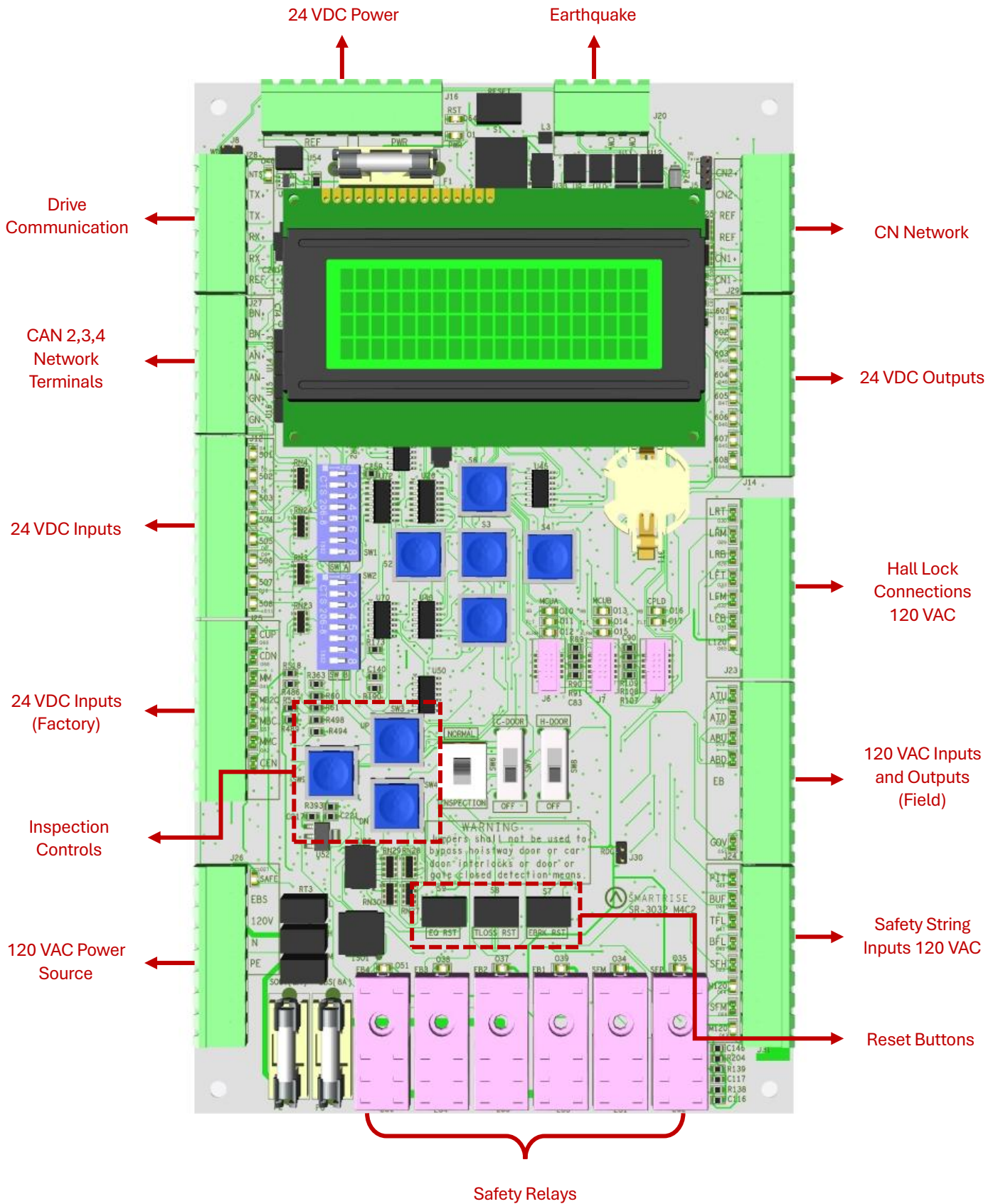

Figure 68: MR Board - SR3032

## 2.1 Navigation Buttons

The navigation buttons are the same on every SRU board.

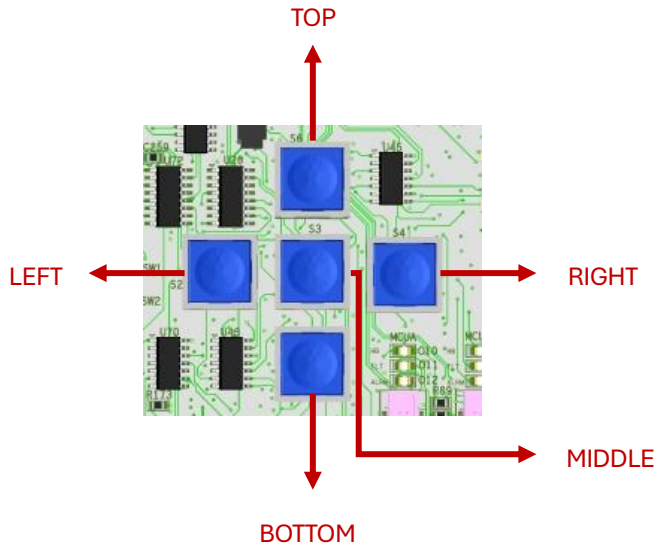

Figure 69: Navigation Buttons

Descriptions of the navigation buttons are provided in the table below.

Table 36: Navigation Buttons' Description

Button	Description
Top	Scrolls up through selected menu
Bottom	Scrolls down through selected menu
Left	Navigates back to Main Menu
Right	Navigates right through series of menus/submenus
Middle	Selects menu

A selected menu within a menu list is indicated with an asterisk (\*) as shown in the figure below.



Figure 70: Example of Selected Menu

## 2.2 24 VDC Power Source

A single terminal is sufficient to connect the 24 VDC Power and Reference to the MR board. Additional terminals may be used for auxiliary connections as necessary.

### 2.3 EBRK Reset Button

The EBRK Reset button clears latched faults.

To reset, press and immediately release the button. The fault will clear after approximately 5–6 seconds.

### 2.4 Normal Terminal Stop

The NTS connector activates the Normal Terminal Stop (NTS) operation.

**NTS Terminal:** The NTS output from the MR Board connects to the Valve Board and controls the operation of the high UH/DH valves. When NTS is active, the valves are cut off, causing the car to transition from high speed to leveling speed.

### 2.5 Network

The network enables board-to-board communication between the Machine Room, Car Top, Car Operating Panel, and Expansion Boards.

- **CN Network Terminals:** Use both CN1 and CN2 for communication.
- **REF Terminal:** Provides a ground reference to reduce noise on the CN1 and CN2 signals.

These connections must be established before switching to Inspection or Normal operation.

- **Valve Network (BN) Terminals:** Facilitate communication between the Machine Room and the Valve Board.
- **Auxiliary Network (AN) Terminals:** Enable auxiliary communication between the Machine Room and compatible third-party devices (e.g., IE CE Drive Board).
- **Group Network (GN) Terminals:** Provide group communication by linking all cars together in a group configuration

### 2.6 120 VAC Inputs and Outputs (Factory)

#### **WARNING**

**ALL CONNECTIONS ON THIS TERMINAL BLOCK ARE HIGH VOLTAGE. DISCONNECT POWER TO THE CONTROLLER BEFORE WIRING THESE TERMINALS.**

- **SAFE Terminal:** Provides the SAFE output from the MR Board to the Valve Board to activate the UH/DH valves.
- **EBS Terminal:** Neutral voltage input from the main line.

### 2.7 24 VDC Inputs and Outputs

The 24 VDC inputs are labelled 501-508. Each input is activated by applying 24 VDC to the corresponding terminal. LEDs 501–508 will illuminate when their respective inputs are active.

The 24 VDC outputs are labeled 601–608. Each output sinks to REF when activated. LEDs 601–608 will illuminate when their respective outputs are active.

### 2.8 24 VDC Monitoring System

The monitoring connector is used to monitor the system. Each terminal has a corresponding LED that lights when active.

- **CUP and CDN Inputs:** Control the car's movement UP or DOWN using an external run box.
- **MM Terminal:** Switches the controller between Construction Mode (when the INSPECTION switch is ON) and Test Mode (when the INSPECTION switch is OFF). To activate this input, a jumper must be installed from 24 VDC to the terminal.
- **CEN Terminal:** Monitors the enable contact status on the external run box during Construction Mode. This input must be enabled before the CUP and CDN inputs.

## 2.9 Safety String Inputs 120 VAC

### **WARNING**

**ALL CONNECTIONS ON THIS TERMINAL BLOCK ARE HIGH VOLTAGE. DISCONNECT POWER TO THE CONTROLLER BEFORE WIRING THESE TERMINALS.**

This terminal block contains connections for the controller safety string. Each input is continuously monitored. The source and termination points for all Machine Room and Hoistway safety devices are located on this block. Each terminal has a corresponding LED that lights when active.

- **PIT Terminal:** Termination point for the Pit switch. The primary side of the switch connects to H120, and the secondary side is wired back to the PIT terminal.
- **BUF Terminal:** Termination point for the Buffer switch. The primary side connects to H120, with the secondary side wired back to the BUF terminal.
- **TFL Terminal:** Termination point for the Top Final Limit switch. The primary side connects to H120, with the secondary side wired back to the TFL terminal.
- **BFL Terminal:** Termination point for the Bottom Final Limit switch. The primary side connects to H120, with the secondary side wired back to the BFL terminal.
- **H120 Terminal:** Internal fused power source for all hoistway safety devices. This terminal powers the PIT, BUF, BFL, TFL, and any additional hoistway safety devices.
- **SFM Terminal:** Termination point for all Machine Room safety devices without dedicated inputs, such as the Run/Stop switch. Additional devices are wired in series and terminated here (e.g., relays EB1-EB4 that verify motor safety).
- **SFH Terminal:** Termination point for all hoistway safety devices without dedicated inputs. Additional devices are wired in series and terminated here.
- **M120 Terminal:** Internal fused power source for all Machine Room safety devices.

## 2.10 120 VAC Inputs and Outputs (Field)

### **WARNING**

**ALL CONNECTIONS ON THIS TERMINAL BLOCK ARE HIGH VOLTAGE. DISCONNECT POWER TO THE CONTROLLER BEFORE WIRING THESE TERMINALS.**

The following are input terminals:

- **ATU Terminal:** Access Top Up controller termination.
- **ATD Terminal:** Access Top Down controller termination.
- **ABU Terminal:** Access Bottom Up controller termination.
- **ABD Terminal:** Access Bottom Down controller termination.

The following is an output terminal:

- **EB Terminal:** Connects the neutral voltage to the Valve Board. The EB terminal will not output voltage until all safety checks are successfully completed.

## 2.11 Hall Lock Connections

### **WARNING**

**ALL CONNECTIONS ON THIS TERMINAL BLOCK ARE HIGH VOLTAGE. DISCONNECT POWER TO THE CONTROLLER BEFORE WIRING THESE TERMINALS.**

- **LRT Terminal:** Terminates the rear top lock. The primary side of the lock connects to L120, and the secondary side is wired back to this terminal.
- **LRM Terminal:** Terminates the rear middle locks. The primary side connects to L120, with the secondary side wired back to this terminal.
- **LRB Terminal:** Terminates the rear bottom lock. The primary side connects to L120, with the secondary side wired back to this terminal.
- **LFT Terminal:** Terminates the front top lock. The primary side connects to L120, with the secondary side wired back to this terminal.
- **LFM Terminal:** Terminates the front middle locks. The primary side connects to L120, with the secondary side wired back to this terminal.
- **LFB Terminal:** Terminates the front bottom lock. The primary side connects to L120, with the secondary side wired back to this terminal.
- **L120 Terminal:** Internally fused source supplying all lock voltages.

## 2.12 Inspection Controls

- **Enable Button:** Enables power to the direction commands during Inspection operation. This button must be pressed before issuing any movement commands in Inspection mode.
- **Inspection Switch:** Toggles between Inspection and Normal operation. When the MM input signal is high and the switch is set to INSPECTION, the system enters Construction Mode. When set to NORMAL, the system operates in Test Mode.
- **Up and Down Buttons:** Move the car up or down during Inspection.
- **Car and Hall Door Bypass Switches:** Bypass the Hall Locks and Gate Switch only during CT and IC Inspection. These switches replace jumpers to minimize the risk of accidentally leaving a jumper connected. They must not be used during Construction Mode; using them outside of CT or IC inspection causes the controller to fault.

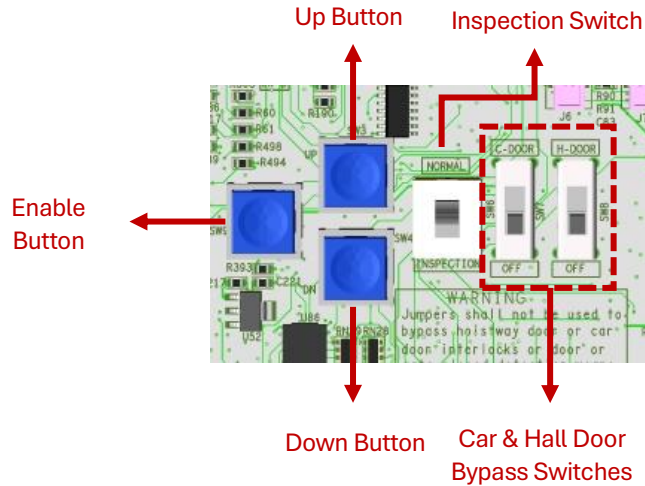

Figure 71: MR Board SR3032 Inspection Control

### 2.13 Safety Relays

- **SFM:** Force-guided relay controlled by the main processor. Its status is monitored by both the main and safety processors. When active, the relay’s contacts in series with **SFP** output voltage to the **SAFE** terminal to control the valves.
- **SFP:** Force-guided relay controlled by the safety processor. Its status is monitored by both the main and safety processors. When active, the relay’s contacts in series with **SFM** output voltage to the **SAFE** terminal to control the valves.
- **EB1:** Force-guided relay controlled by the safety processor. Its status is monitored by both the main and safety processors. When active, the relay’s contacts in series with **EB2** pass voltage from the **EBS** terminal to the **EB** terminal.
- **EB2:** Force-guided relay controlled by the main processor. Its status is monitored by both the main and safety processors. When active, the relay’s contacts in series with **EB1** pass voltage from the **EBS** terminal to the **EB** terminal.
- **EB3:** Force-guided relay controlled by the safety processor. Its status is monitored by both the main and safety processors. When active, the relay’s contacts in series with **EB3** pass voltage from the **EBS** terminal to the **EB** terminal.
- **EB4:** Force-guided relay controlled by the main processor. Its status is monitored by both the main and safety processors. When active, the relay’s contacts in series with **EB1** pass voltage from the **EBS** terminal to the **EB** terminal.

**NOTE:** EB3 and EB4 are used only during preflight operation to bypass EB1 and EB2, allowing EB1 and EB2 to toggle without dropping the EB output.

### 3 CT/COP Board SR3030

The LEDs on the SRU board indicate the status of each terminal and processor through three colors:

- **Red:** A fault has been detected, or the board is in the process of resetting.
- **Yellow:** Indicates an active output terminal or an alarm condition on the processors.
- **Green:** Indicates power on an input terminal, power to the board, and a "heartbeat" signal showing the processor software is running.

Each LED on the CT/COP board has a reference designator.

Input terminals are labeled **501 through 5XX** (up to 508 on the MR board).

**24 VDC** must be connected to input terminals to power the logic circuitry.

**⚠ WARNING**

**DO NOT APPLY AC CURRENT TO THE INPUT TERMINALS. APPLYING AC CURRENT WILL DAMAGE THE BOARD.**

The output terminal connects to the **negative** side of the load and provides a **reference (REF)** signal. The **positive** side of the load must be connected to a **24 VDC power source**.

If the yellow LED is **not** illuminated, the output transistors are inactive and the load is not energized.

**⚠ WARNING**

**DO NOT APPLY 24 VDC DIRECTLY TO THE OUTPUT TERMINAL WITHOUT A CURRENT-LIMITING DEVICE. THIS WILL DAMAGE THE OUTPUT TRANSISTORS.**

The Serial Communication ports are as follows:

- **1\* (CN2+ CN2-):** Serial communication from the CT to the MR board (Safety Network)
- **2\* (CN1+ CN1-):** Serial communication for devices on the car network
- **3\* (C3H and C3L):** Serial communication to third-party devices (e.g., Fixture Driver board)

**CAT5\*:** Supplies power and two serial communication channels.

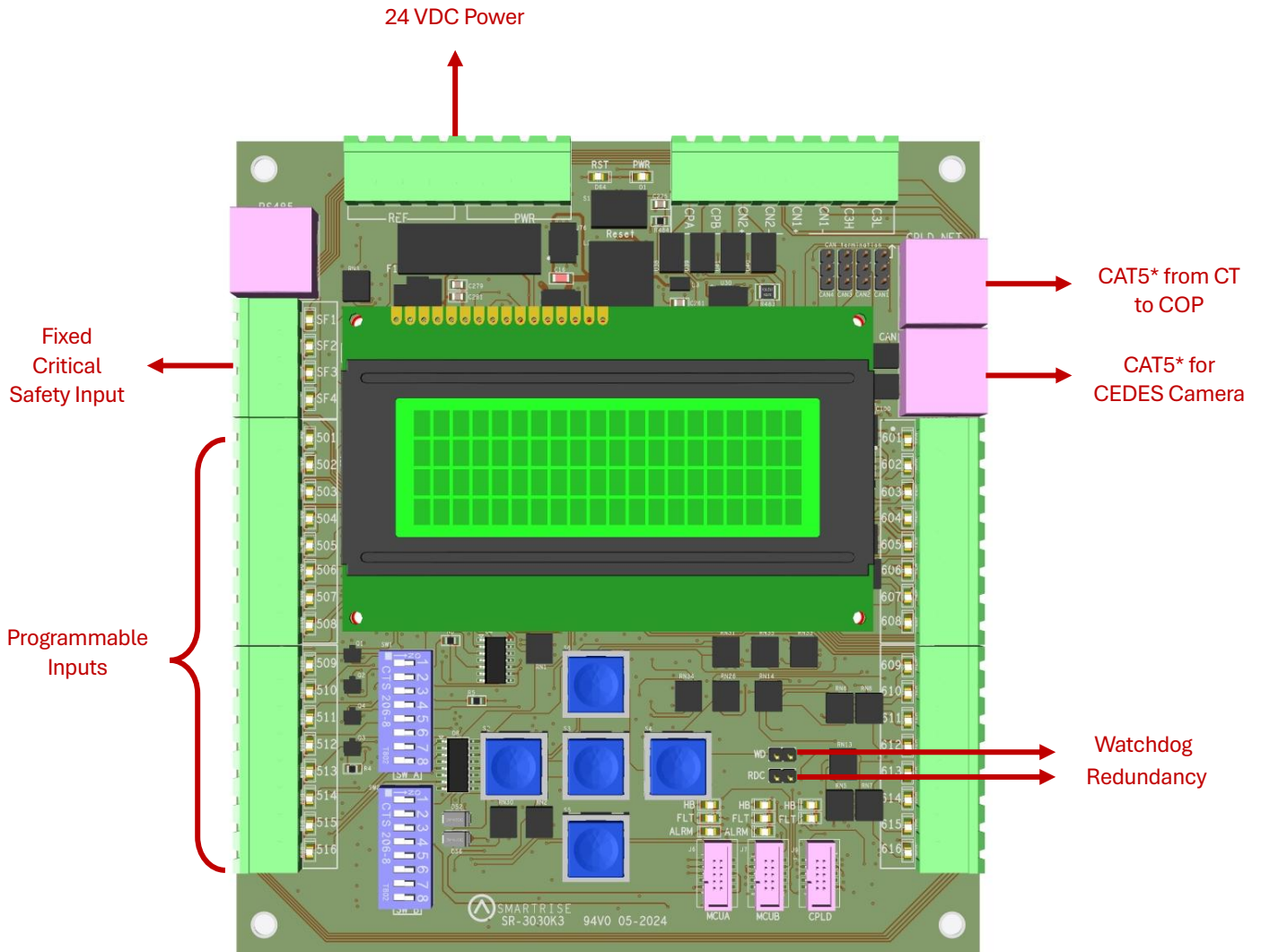

Figure 72: SRU Board SR3030

There are two DIP switch banks on the SR3030 board:

- **Bank A (upper)**
- **Bank B (lower)**

Each bank is configured for specific functionalities. The table below outlines the DIP switch settings for Bank A on the SR3030 CT/COP board.

Table 37: CT/COP Board SR3030 Bank A DIP Switch Setting Configuration

DIP Switch	Functionality	Description
DIP 1	CPU Stop Switch	Halts parameters updates and used to reset some latched faults.
DIP 2	N/A	N/A
DIP 3	N/A	N/A
DIP 4	N/A	N/A
DIP 5	N/A	N/A
DIP 6	N/A	N/A
DIP 7	Pop-up Blocker	Disables the fault pop-up messages.

Faults can still be viewed in the active and logged faults.		
<b>DIP 8</b>	N/A	N/A

The table below outlines the DIP switch settings for Bank B on the SR3030 CT/COP board.

Table 38: CT/COP Board SR3030 Bank B DIP Switch Setting Configuration

DIP Switch	Functionality	Description
<b>DIP 1</b>	COP (not CT)	Must be turned on for COP operation and off for CT operation.
<b>DIP 2</b>	Enable Rear Doors	Must be set if rear doors are present.
<b>DIP 3</b>	N/A	N/A
<b>DIP 4</b>	N/A	N/A
<b>DIP 5</b>	N/A	N/A
<b>DIP 6</b>	N/A	N/A
<b>DIP 7</b>	N/A	N/A
<b>DIP 8</b>	N/A	N/A

## 4 I/O Board/Riser Board SR3031

The SR3031 board can operate in two configurations:

### 1. Riser Board Mode (DIP switch 8 = ON)

Used for Fire Service, Emergency Power connections, and Hall Network integration.

Additional riser boards are added by incrementing the DIP switch address. For example:

- Riser Board 1 → DIP 8 ON
- Riser Board 2 → DIP 8 and DIP 1 ON

A maximum of four Riser boards can be used per system.

### 2. Expansion Board Mode (DIP switch 8 = OFF)

Used to provide **programmable 24 VDC inputs and outputs**.

Expansion boards are grouped in sets of eight.

Up to 40 Expansion boards are supported in the system.

**Master/Slave Switch** configures the **secondary CAN network** on SR3031:

- **Slave Position:** CAN1 and CAN2 terminals are **mirrored** (connected to the same network).
- **Master Position:** CAN1 and CAN2 terminals are **independent** (connected to separate networks).

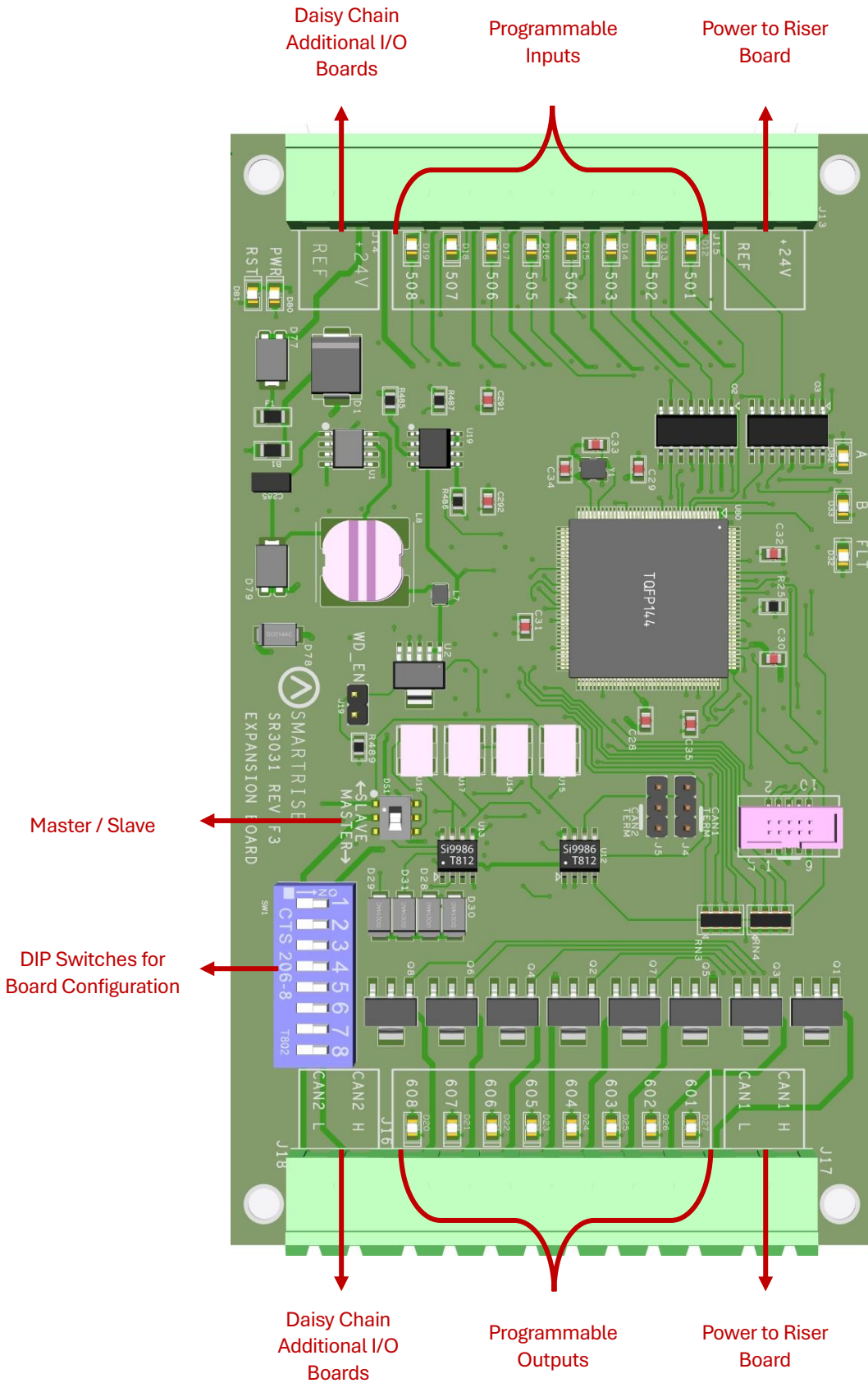

Figure 73: I/O Board/Riser Board SR3031

The table below lists the I/O Board SR3031 DIP switch settings.

Table 39: I/O Board SR3031 DIP Switch Settings

DIP Switch	Functionality
DIP 1	Slave ID 1
DIP 2	Slave ID 2
DIP 3	Slave ID 3
DIP 4	I/O Master ID 1
DIP 5	I/O Master ID 2
DIP 6	I/O Master ID 3
DIP 7	I/O Master ID 4
DIP 8	Riser Board

### 4.1 Group Redundancy

The Group Redundancy feature monitors communication with pre-connected Riser boards and responds to communication loss by switching to a redundant set of boards.

Monitoring behavior depends on the number of Riser boards connected:

- If only one Riser board is connected, only that board is monitored.
- If four Riser boards are connected, all four are monitored for communication loss.

If any connected Riser board loses communication for more than 10 seconds, the system sends a signal to activate a relay group. This shuts down the primary Riser board set and activates the redundant set.

If no Riser boards are connected at power-up, Group Redundancy will be disabled, and no boards will be monitored.

To enable proper functionality, the following wiring is required:

- All I/Os between the primary and redundant Riser 1 boards must be wired in parallel.
- Hall board communication lines between the primary and redundant Riser 1 boards must also be wired in parallel.
- Control relays must be installed to manage power delivery to both the primary and redundant Riser 1 boards.

## 5 24 Input Board SR3041

The SR3041 board functions similarly to the SR3031 I/O Expansion board, but with one key difference – It has no output terminals, it is strictly for inputs.

The SR3041 provides three sets of eight assigned inputs, allowing it to replace three SR3031 boards. Like the SR3031, the SR3041 can be daisy-chained to either additional SR3041 or SR3031 boards.

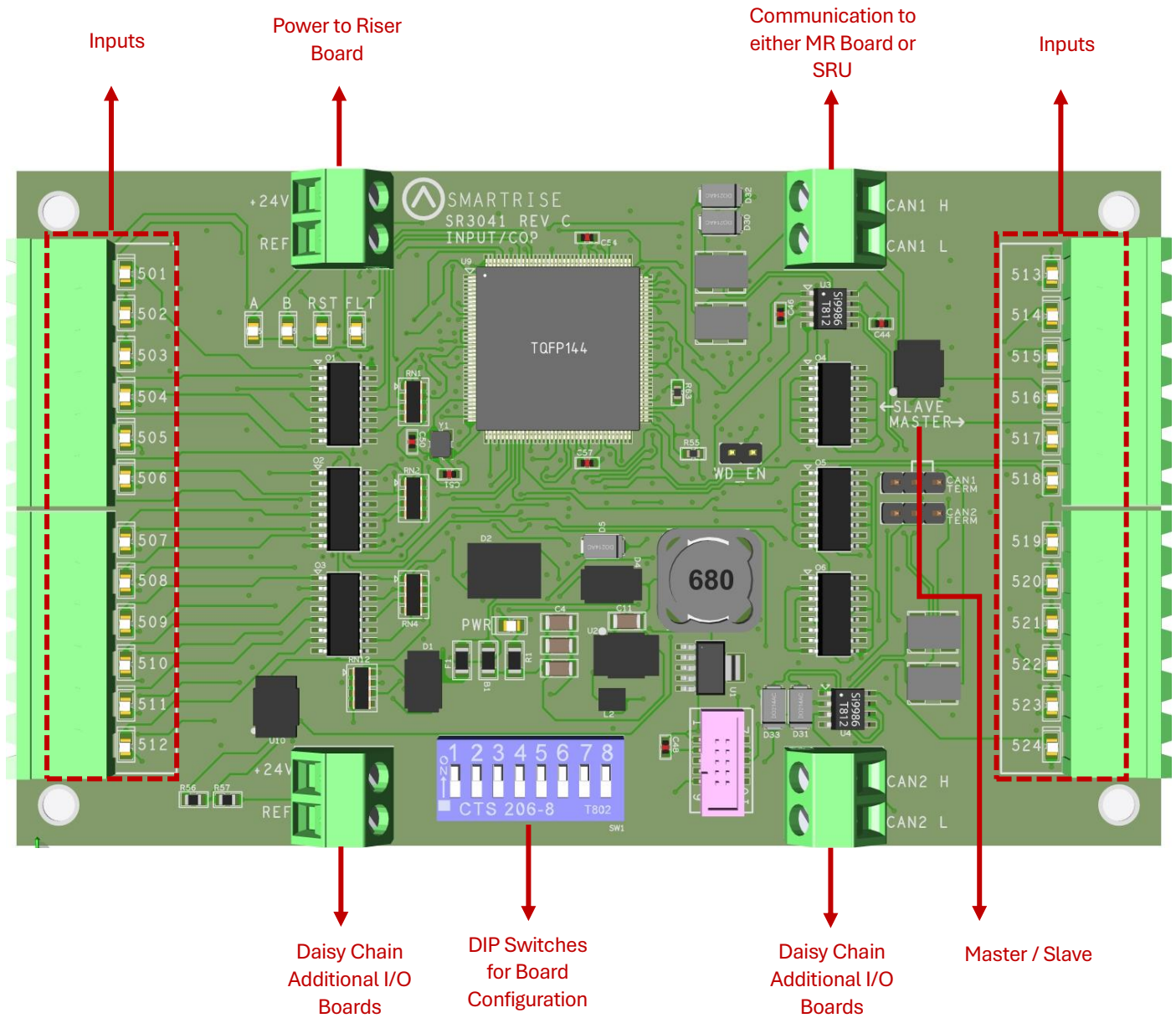

Figure 74: 24 Input Board SR3041

The serial communication is as follows:

- **CAN1:** The Master board connects to the COP board’s AUX Net.
- **CAN2:** The Master board connects to CAN1 of the Slave board.

**NOTE:** CAN2 of each Slave board will be connected to CAN1 to the following Slave board.

The assigned input for wiring is as follows:

- **501–508** → First Address
- **509–516** → Second Address
- **517–524** → Third Address

The table below outlines the DIP switch settings for the 24 Input SR3041 board.

Table 40: 24 Input Board SR3041 DIP Switch Settings

DIP Switch	Functionality
DIP 1	Slave ID 1
DIP 2	Slave ID 2
DIP 3	Slave ID 3
DIP 4	I/O Master ID 1
DIP 5	I/O Master ID 2
DIP 6	I/O Master ID 3
DIP 7	I/O Master ID 4
DIP 8	Unused

**NOTE:** This board will occupy the expansion board address shown on its DIPs, as well as the next two slave addresses.

Depending on the location of the 24 Input board on the controller, the DIP switches have to be set to certain positions. The address of the board depends on the type of board previously used. If the previous board is a SR3041, the address is the previous board’s address +3. If the previous board is a SR3031, the address is the previous board’s address +1. If this Input board is the first board within the chain, turn OFF all DIP switches. The 24 Input board will mimic SR3031 Expansion boards (1-3).

If this Input board follows directly after the first 24 Input board in the chain, turn ON DIP switches 1 and 2 only. The 24 Input board will mimic SR3031 Expansion boards (4-6).

If another 24 Input board follows directly after the first two 24 Input boards within the chain, turn ON DIP switches 2 and 3 only. The 24 Input board will mimic SR3031 Expansion boards (7-9).

The DIP switch configuration table for the SR3041 when acting as master is provided below.

Table 41: 24 Input Board SR3041 DIP Switch Settings When SR3041 is Master

Board Type	DIP 1	DIP 2	DIP 3	DIP 4	DIP 5	DIP 6	DIP 7	DIP 8
SR30041 (Master)								
SR3041 (Slave)	X	X						
SR3041 (Slave)		X	X					

X = Turn DIP switch ON

The DIP switch configuration table for the SR3031 when acting as master is provided below.

Table 42: 24 Input Board SR3041 DIP Switch Settings When SR3031 is Master

Board Type	DIP 1	DIP 2	DIP 3	DIP 4	DIP 5	DIP 6	DIP 7	DIP 8
SR3031 (Master)								
SR3041 (Slave)	X							
SR3041 (Slave)			X					

X = Turn DIP switch ON

## 6 Valve Board

The Valve Board manages oil flow to and from the hydraulic cylinder, enabling car movement.

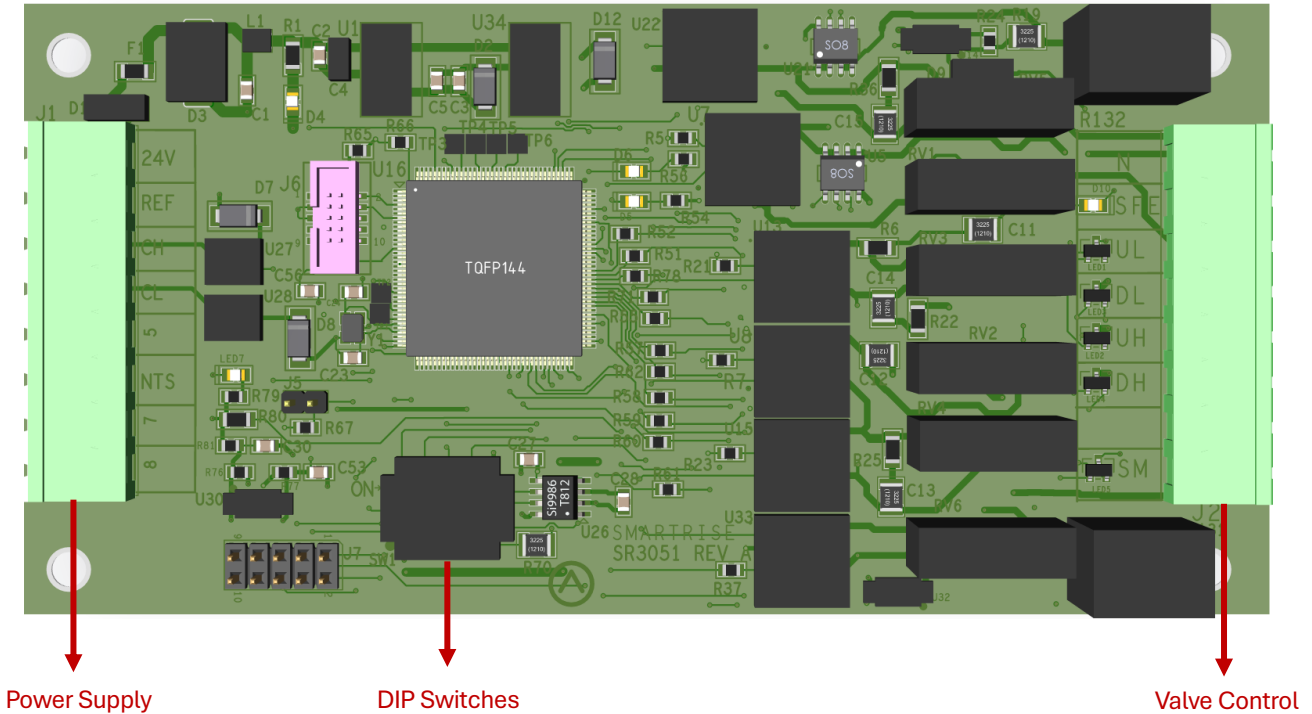

Figure 75: Valve Board Example – SR3051

### Signal Overview:

- **Neutral:** Input signal from the **EB output** on the MR board. Controls valve open/close behavior.
- **UL:** Activates valve at **leveling speed** upward.
- **DL:** Activates valve at **leveling speed** downward.
- **UH:** Activates valve at **high speed** upward.
- **DH:** Activates valve at **high speed** downward.
- **CH and CL:** Communication channels between the Valve Board and MR Board.

### DIP Switches:

- **DIP 1 & DIP 2:** Used for Valve Selection (refer to the valve selection table below for proper settings.)
- **DIP3:** Open Circuit Disable.
- **DIP4:** WDT Disable.
- **DIP5:** CAN Termination Resistor.

Table 43: Valve Select

DIP 1	DIP 2	Valve Board ID
OFF	OFF	1
ON	OFF	2
OFF	ON	3
ON	ON	4

## 7 Hall Board SR1060

The SR1060 Hall Board is wired discretely and supplies power to the buttons and lamps on the fixture. Depending on the controller configuration, the board is available with either 10 DIP switches or 12 DIP switches.

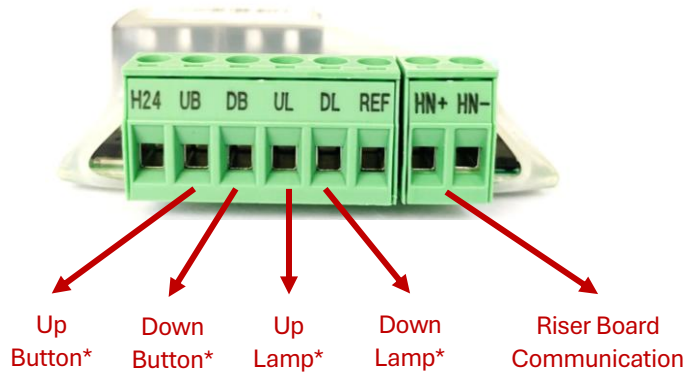

\* = 24 VDC

Figure 76: 10 DIP Hall Board SR1060-E

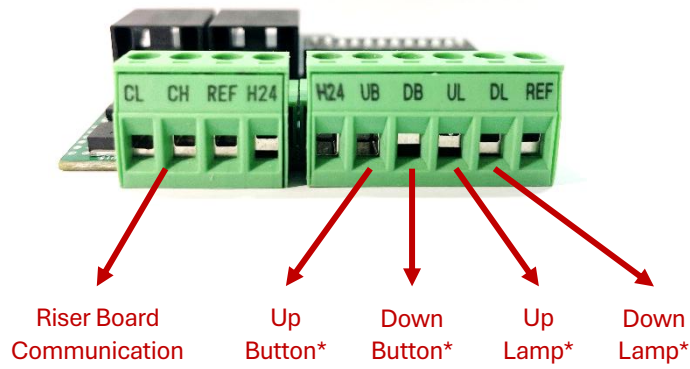

\* = 24 VDC

Figure 77: 12 DIP Hall Board SR1060-G

The communication options with the Riser board are as follows:

- **CAN Bus** via twisted pair
- **CAT5 Cable**

The table below lists the Hall Board 10 DIP switch settings.

Table 44: Hall Board 10 DIP Switch Settings

DIP Switch	Functionality
DIP 1	Landing ID 1
DIP 2	Landing ID 2
DIP 3	Landing ID 3
DIP 4	Landing ID 4
DIP 5	Landing ID 5

<b>DIP 6</b>	Landing ID 6
<b>DIP 7</b>	Function ID 1
<b>DIP 8</b>	Function ID 2
<b>DIP 9</b>	Function ID 3
<b>DIP 10</b>	CAN Termination

The table below lists the Hall Board 12 DIP switch settings.

Table 45: Hall Board 12 DIP Switch Settings

<b>DIP Switch</b>	<b>Functionality</b>
<b>DIP 1</b>	Landing ID 1
<b>DIP 2</b>	Landing ID 2
<b>DIP 3</b>	Landing ID 3
<b>DIP 4</b>	Landing ID 4
<b>DIP 5</b>	Landing ID 5
<b>DIP 6</b>	Landing ID 6
<b>DIP 7</b>	Landing ID 7
<b>DIP 8</b>	Function ID 1
<b>DIP 9</b>	Function ID 2
<b>DIP 10</b>	Function ID 3
<b>DIP 11</b>	N/A
<b>DIP 12</b>	CAN Termination

---

# LANDING SYSTEM

---

## 1 SmartPositioning Landing System

The SmartPositioning Landing System tracks elevator speed and position with high precision and superior reliability. It incorporates a contactless dual infrared sensor system, QR Code tape and a SmartClip consolidated mounting system that reduces installation time and maintenance. The system increases performance and reliability.

The SmartPositioning Landing System consists of:

- Coded Tape.
- Sensor Array Assembly.
- Tape Clip Assembly.
- Top Tape Mount Assembly.
- Bottom Tape Mount Assembly.

### 1.1 Coded Tape

The tape is a special coded tape that provides the absolute positioning feedback to the CEDES camera.



Figure 78: Coded Tape

#### ⚠ WARNING

THE TAPE EDGE IS SHARP. CUT-PROOF GLOVES MUST BE WORN WHILE HANDLING THE TAPE.



Figure 79: Gloves Required

The steps below describe how to install the tape.

1. Open the tape box at the top corner, being mindful of the sharp ends or edges, and pull out the tape as needed.

**CAUTION:** Do not pull out too much tape from the box as excessive bending can occur and damage the tape.

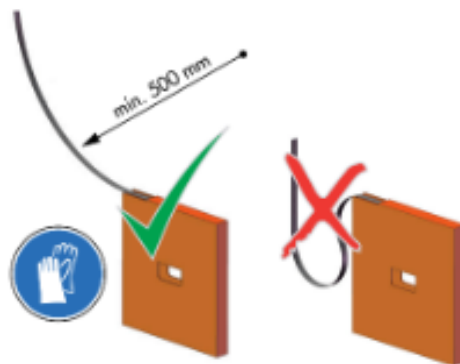

Figure 80: Tape Minimum Bend Radius

2. Serpentine and secure the tape through the bracket then zip tie the loose end.
3. Verify the words Left are on the left side of the tape with the barcode facing out towards the camera.

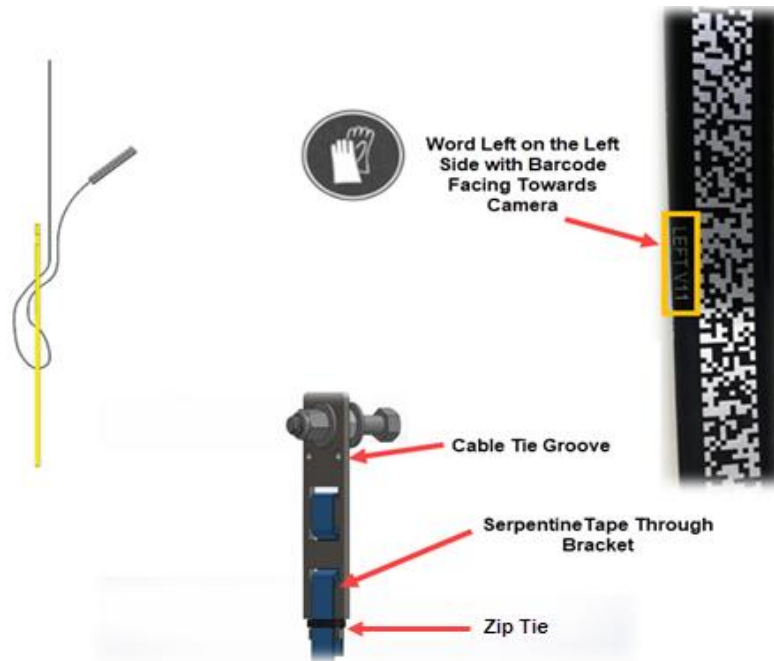

Figure 81: Routing Tape

## 1.2 Sensor Assembly Installation

The steps below describe how to secure the Sensor Assembly to the Car Top Frame C-Channel.

**NOTE:** Exact positioning and lengths of the Unistrut can be adjusted as needed if the Sensor Array is positioned as shown in the figure below.

1. Cut the lengths of Unistrut as follows:
  - Two 18"
  - One 24"
2. Bolt the two 18" lengths of Unistrut to the C-Channel.
3. Bolt the 24" length of Unistrut to the two 18" lengths of Unistrut (the 24" length may be bolted to the top of the two 18" lengths if applicable).

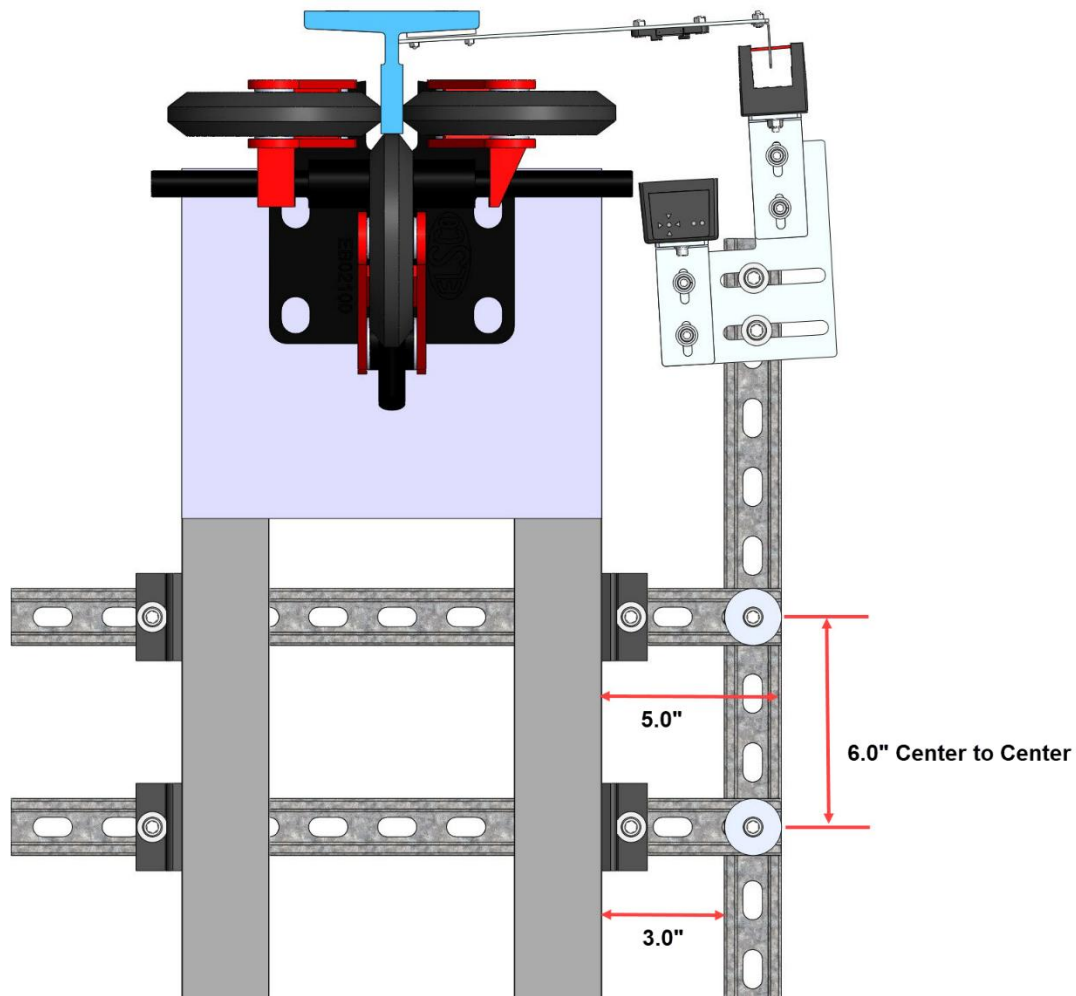

Figure 82: Unistrut Installation

4. Temporarily affix a Tape Clip Assembly on the guide rail to use as an alignment for the Sensor Array Assembly.
5. Set the end of the 24" length Unistrut at 6.5" from the rear surface of the guide rail.
6. Loosely bolt the Sensor Array Assembly onto the 24" length of Unistrut with the Door Zone Blade centered horizontally in the GLS Reader and parallel to the Tape Clip Assembly.

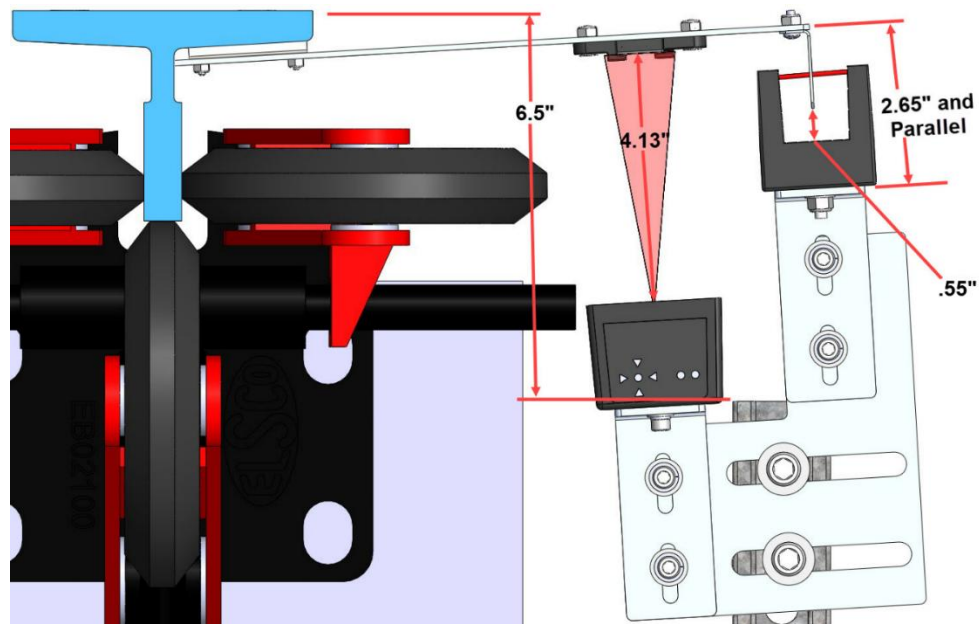

Figure 83: Sensor Array Assembly Positioning

7. Position the Sensor Array Assembly according to the distances shown then tighten all bolts (the Optical Sensor Mount bolts may be loosened if needed to adjust the position of the sensor).
8. After the Sensor Array Assembly positioning has been completed, the Sensor Array Assembly needs to be fine-tuned for proper operation (refer to section **1.7 Fine Tune**).

### 1.3 Upper Tape Mount Assembly

The Upper and Lower Tape Mount Assemblies are located as shown in the image below.

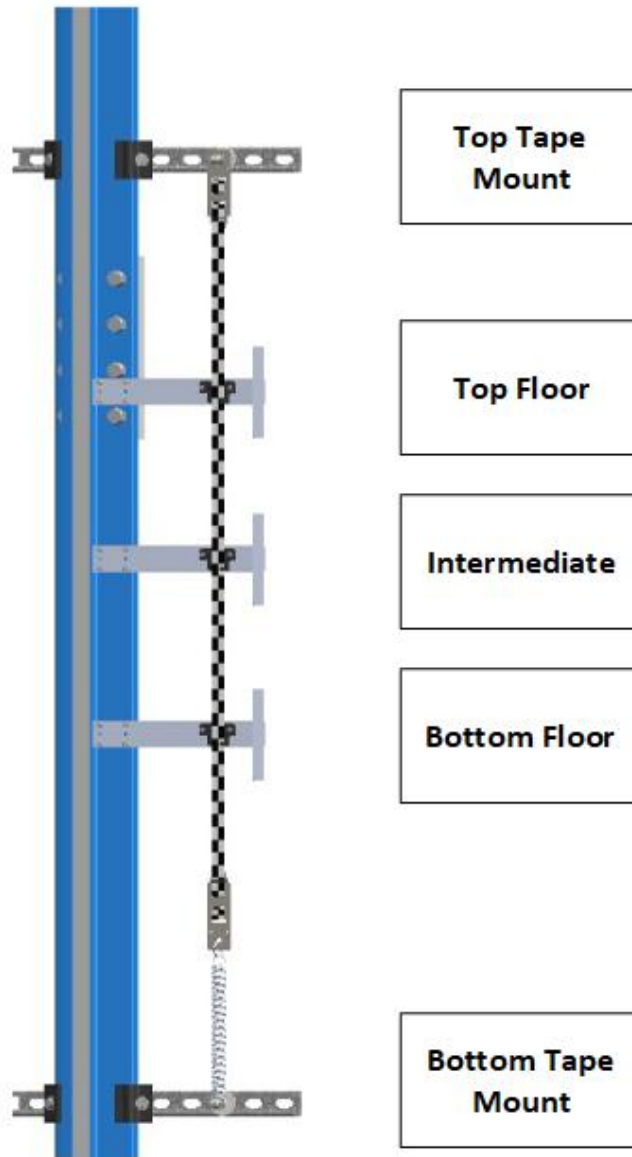

Figure 84: Location of Tape Mount Assemblies

The following procedure describes how to install the Upper Tape Mount Assembly.

1. Affix an 18” length of Unistrut to the top of the guide rail.

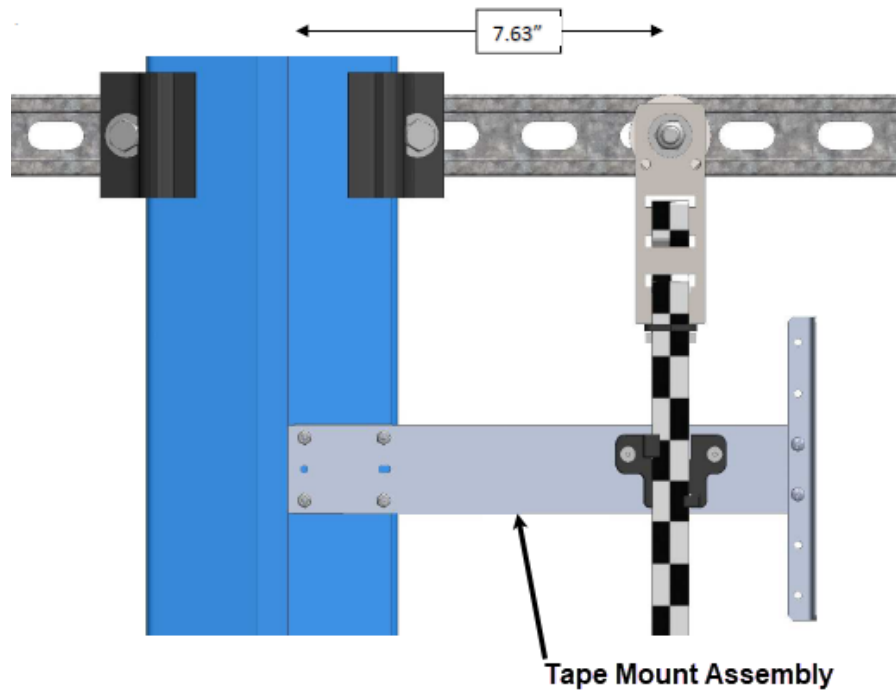

Figure 85: Upper Tape Unistrut Installation

- Loosely attach the hardware to the Upper Tape Mount Assembly.

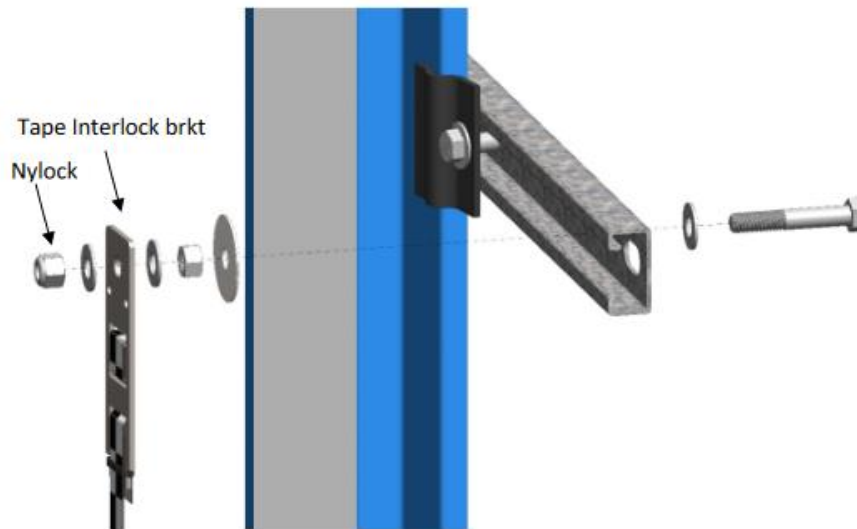

Figure 86: Hardware

- Position the Upper Tape Mount assembly 7.63" from the wheel surface of the guide rail to the center of the 3/8" bolt.
- Temporarily affix a Tape Clip Assembly to the guide rail and onto the tape to verify location.
- Tighten the first hex nut to secure the assembly in place.
- Thread the Nylock nut on the bolt until there is a 0.2" gap between the two flat washers that are on either side of the Tape Interlock bracket. This gap is required to relieve twist in the tape.

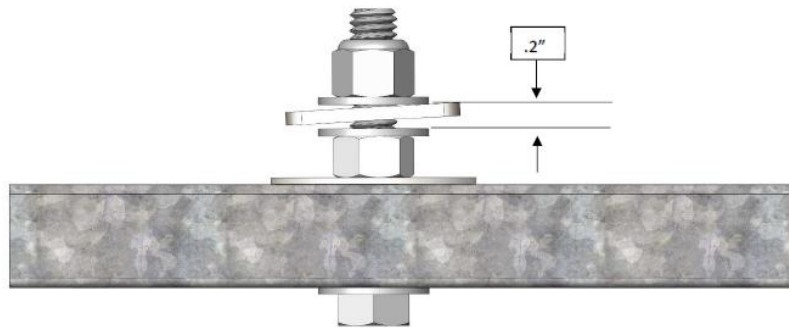

Figure 87: Gap Verification

### 1.4 Tape Clip Assembly

While descending, unspool the tape, install the Tape Clip Assemblies and set the Door Zones (DZ).

The Tape Clip Assembly includes:

- Tape guide clip
- Door zone blade
- Mounting magnets (preassembled)

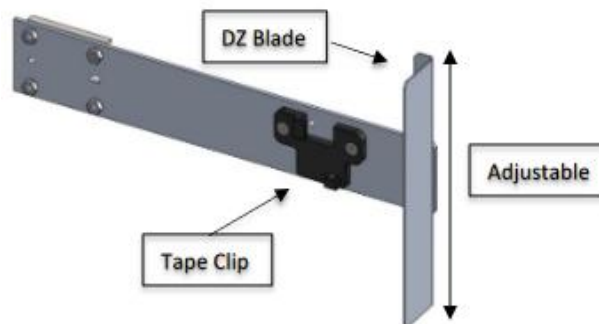

Figure 88: Tape Clip Assembly

In applications where there is 15 ft of distance between door zones, an extra bracket needs to be placed between those door zones. The bracket will only contain the tape clip and NOT the DZ blade. This will minimize tape twisting caused by long distances between the door zones. These extra tape clip brackets will be provided as needed.

The following steps describe how to install the Tape Clip Assembly.

1. Bring the car to floor level.
2. Clean the rail surface at the intended Tape Clip Assembly location.
3. While securing the Tape Clip Assembly with one hand and guiding the tape with the other, rotate the tape into the clip. Avoid twisting or bending the tape to prevent damage.

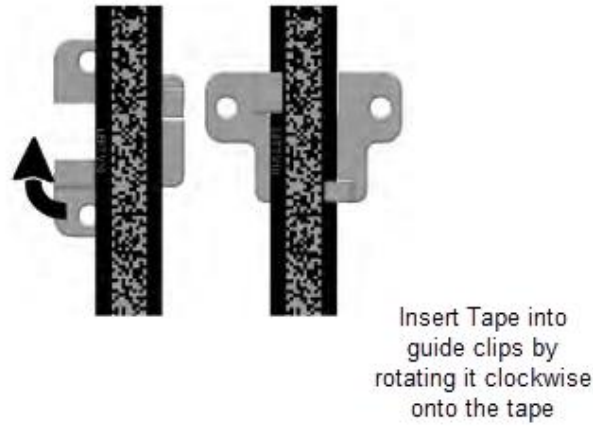

Figure 89: Tape Clip Insertion

- Place the Tape Clip Assembly onto the guide rail with the edge flush to the rail. Strong magnets are used. Do not remove the bracket from the rail by pulling from the far end, as this may cause the bracket to bend.

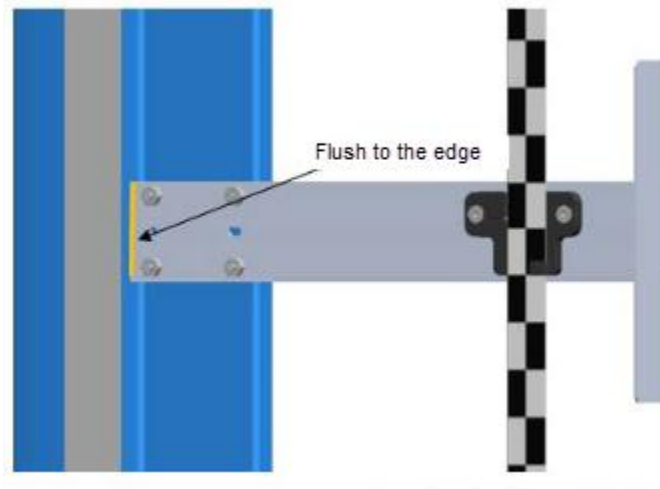

Figure 90: Tape Clip Assembly Alignment

- Verify that the DZ blade is vertically centered with the GLS Reader optical axis.

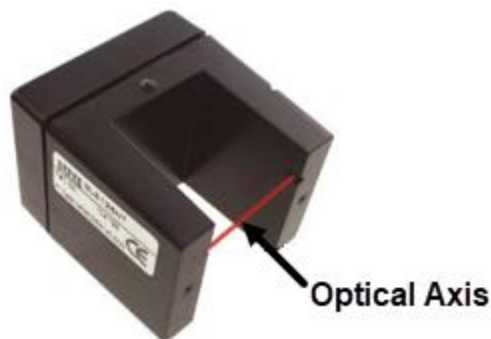

Figure 91: Optical Axis

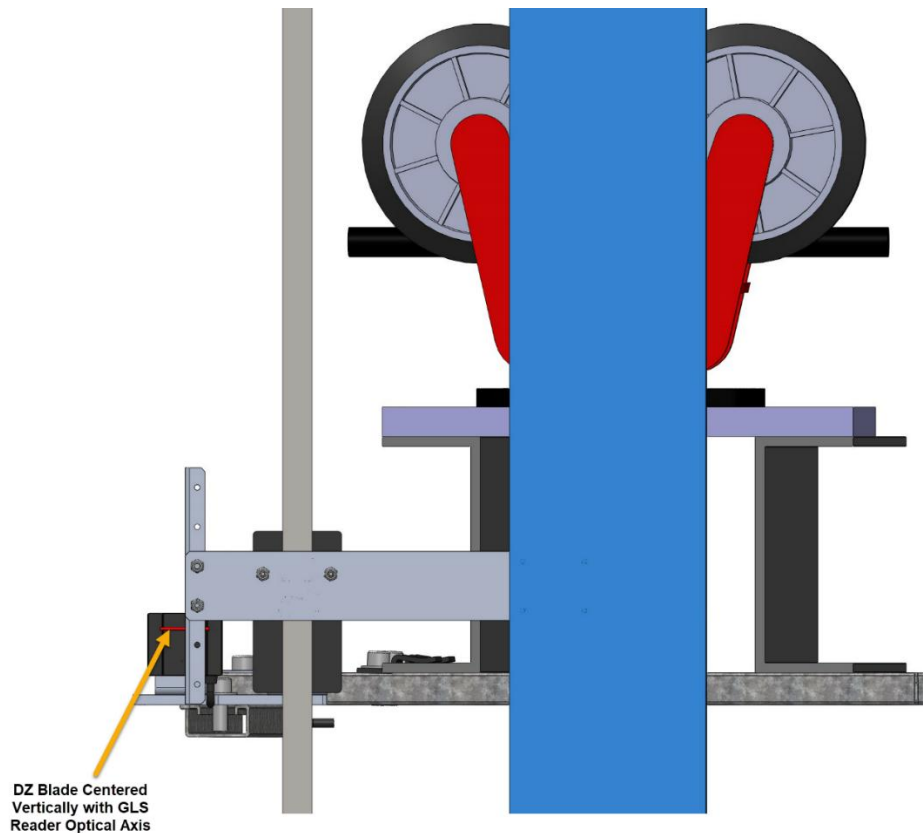

Figure 92: Tape Clip Assembly Placement (Rear View)

6. Check for any bolts or obstructions preventing placement of the Tape Clip Assembly at the required location.
  - i. If bolts or other obstructions are present, remove the two screws, washers, and nuts securing the DZ blade, then adjust the blade up or down. Proceed to Step 7.
  - ii. If no obstructions are present, proceed to step 9.
  
7. Confirm that the Tape Clip Assembly has been placed correctly after adjusting the DZ blade.
  - i. If obstructions remain, install a DZ extension arm. Proceed to Step 8.
  - ii. If no obstructions remain, go to step 9.
  
8. Install the extension arm as follows:
  - i. Remove the DZ blade from the Tape Clip Assembly.
  - ii. Install the door zone extension arm using the original screws, nuts, and washers.
  - iii. Using two additional screws, nuts, and washers provided in the installation kit, mount the DZ blade to the extension arm at the desired position.

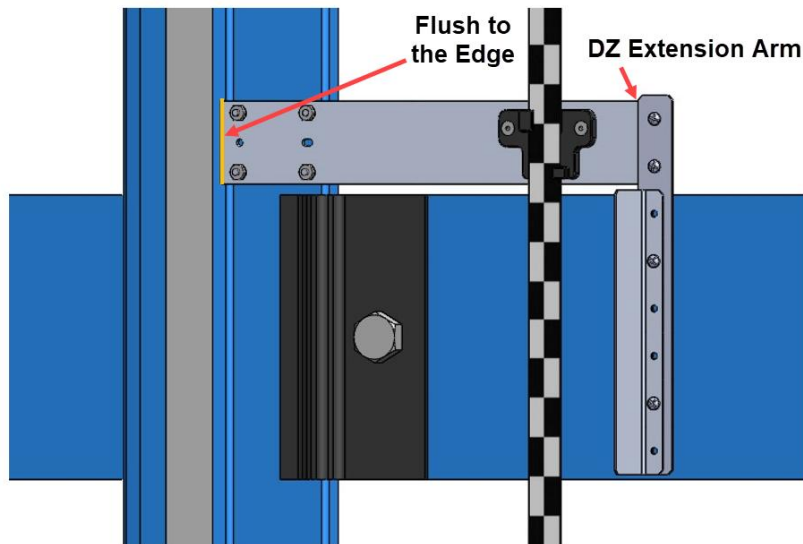

Figure 93: Tape Clip Assembly Alignment

9. Continue down the hoistway, placing the Tape Clip Assembly at each landing.

### 1.5 Lower Tape Mount Assembly

The following procedure describes how to install the Lower Tape Mount Assembly.

1. Affix an 18" length of Unistrut to the bottom of the guide rail.
2. Loosely attach the hardware to the Lower Tape Mount Assembly.
3. Position the Lower Tape Mount Assembly 7.6" from the surface of the guide rail to the center of the 3/8" bolt.

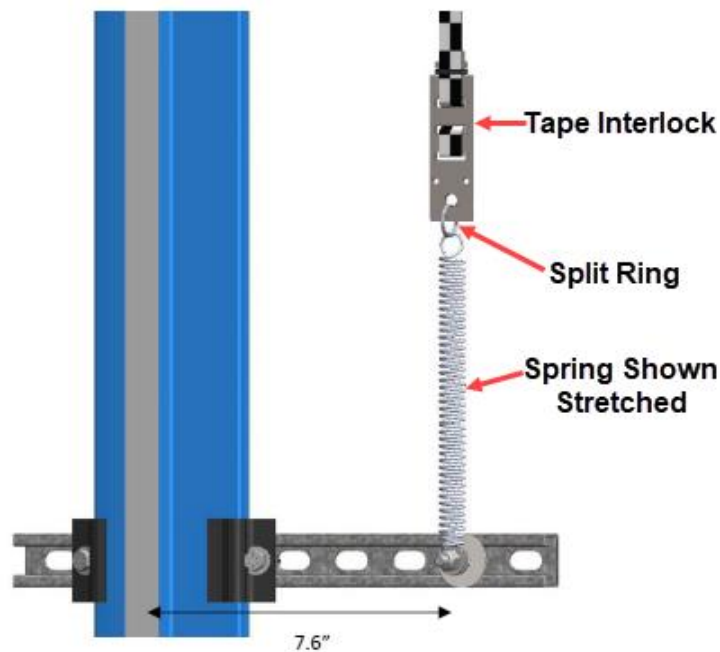

Figure 94: Lower Tape Mount Assembly

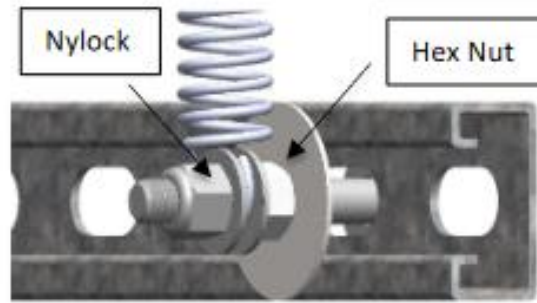

Figure 95: Hardware to Lower Tape Mount Assembly

4. Tighten the first hex nut to secure the Lower Tape Mount Assembly in place.
5. Thread the Nylock nut onto the bolt until the two flat washers located on each side of the spring are just touching the spring loop. This nut does not need to be tightened.
6. Connect the spring to the tape interlock bracket using the split ring.
7. Adjust the spring tension by raising or lowering the Unistrut mounting point so that the spring is stretched to approximately 3”.

## 1.6 Sensor Array Assembly

The Sensor Array Assembly contains the CEDES Optical Sensor, CEDES Exact Position GLS Reader, mounting brackets, and associated hardware. The sensors can be oriented differently as long as the corresponding tape and blades are aligned correctly.

After assembly is complete, connect the CEDES Optical Sensor and the CEDES Exact Position GLS Reader to the CT board and secure cabling.

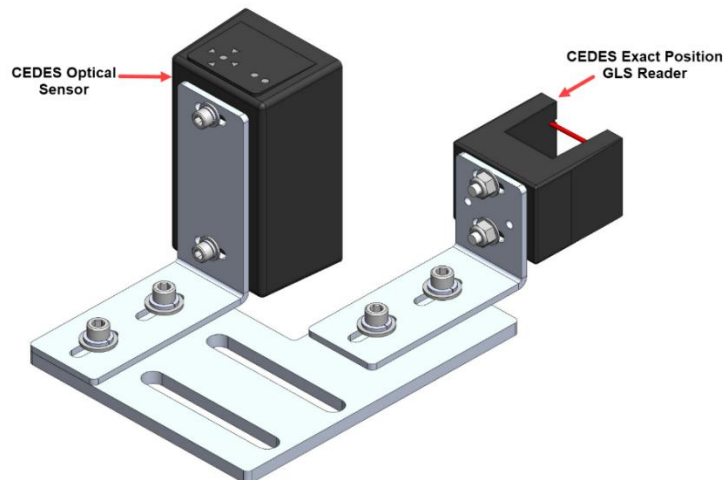

Figure 96: Sensor Array Assembly

The Cedes Optical Sensor and Reader can be connected to either side of the sensor base plate depending upon which side the Sensor Array Assembly is connected to the C-Channel.

The following procedure describes how to connect the Optical Sensor and Reader to either side of the sensor base plate.

1. Remove screws, lock washers, and washers securing the sensor and reader brackets to the sensor base plate.
2. Remove both sensor and reader brackets from the sensor base plate.
3. Flip the sensor base plate.
4. Place the sensor and reader brackets back onto the sensor base plate and secure.

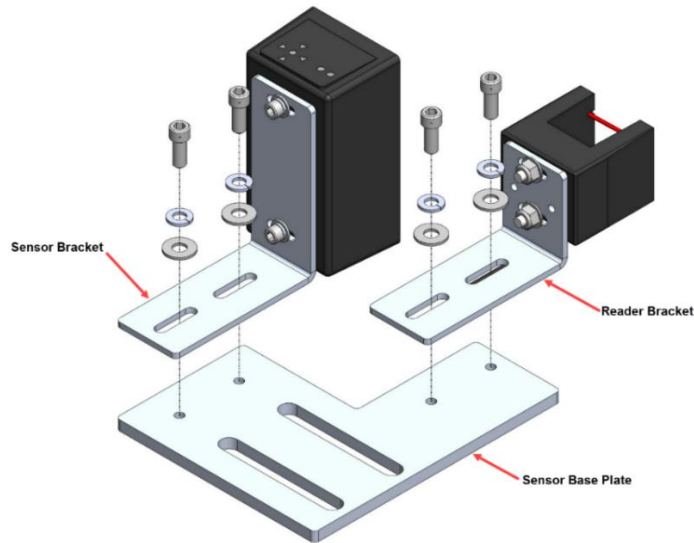

Figure 97: Sensor Array Assembly (Right Side)

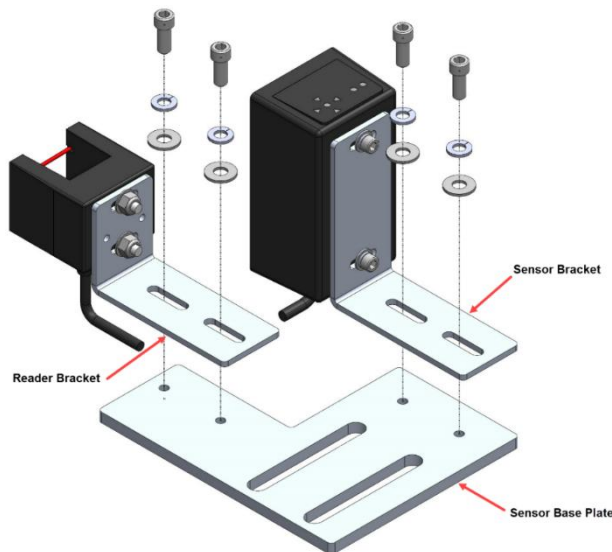

Figure 98: Sensor Array Assembly (Left Side)

A Dual Sensor Array Assembly can be installed if applicable.

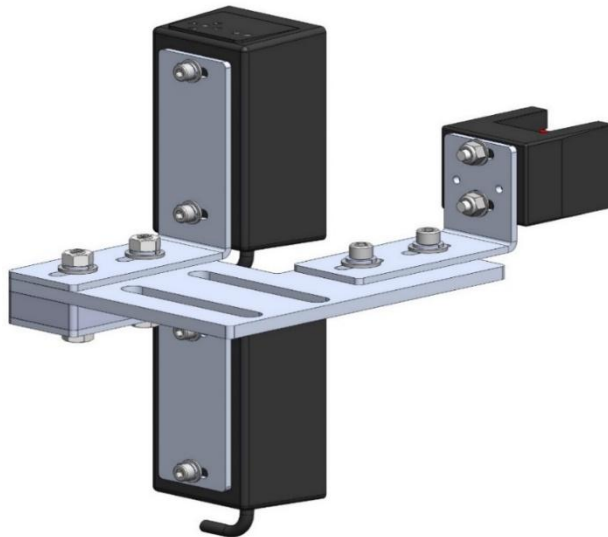

Figure 99: Dual Sensor Array Assembly

The following procedure describes how to connect the Optical Sensor and Reader to either side of the sensor base plate used on a Dual Sensor Array Assembly.

1. Remove screws, lock washers, and washers securing both optical sensors to the sensor brackets and remove optical sensors.
2. Remove screws, lock washers, and washers securing the reader bracket to the bottom sensor base plate and remove reader bracket.

**NOTE:** Do not remove the reader from the reader bracket.

3. Flip the sensor base plate. The spacer is secured to the top of the sensor base plate.
4. Place both optical sensors back onto the sensor brackets with the optical sensor cables facing down and secure.
5. Place the reader bracket back onto the sensor base plate and secure.

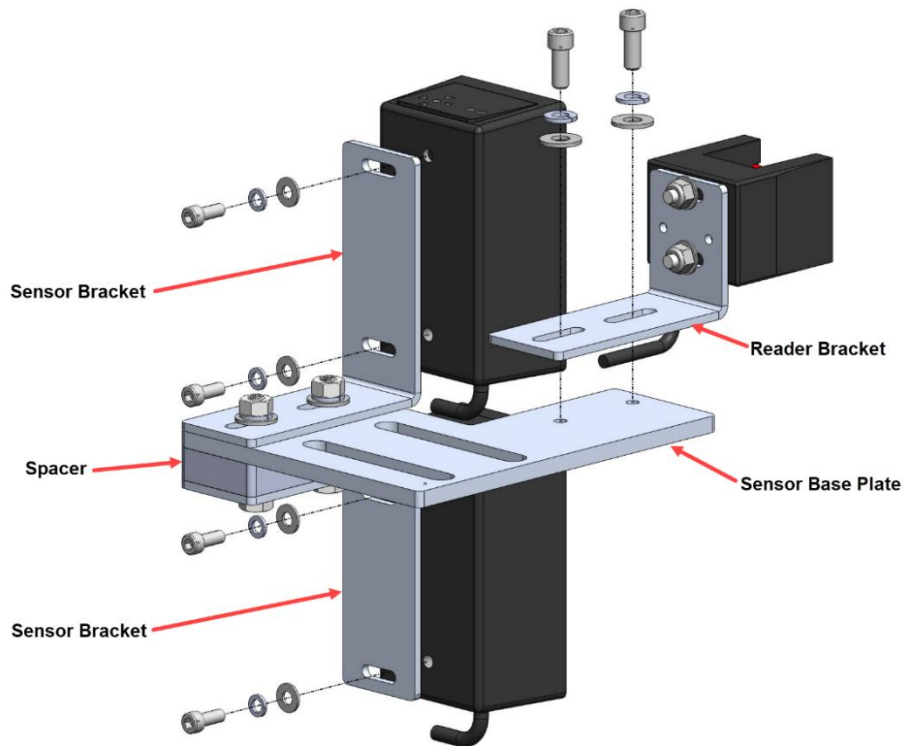

Figure 100: Dual Sensor Array Assembly (Right Side)

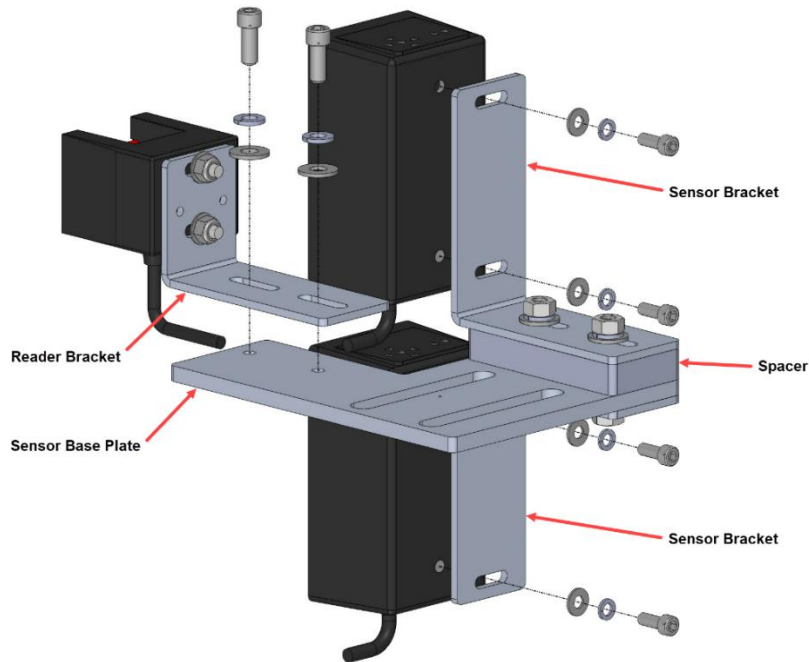

Figure 101: Dual Sensor Array Assembly (Left Side)

## 1.7 Fine Tune

Prior to fine tune, verify the Sensor Array Assembly placement. The Sensor Array Assembly should be at a distance of 4.13" with a tolerance of  $\pm 1$  cm from the tape and parallel to the tape clip mounting brackets. The optical sensor and reader can move front and back, and side to side as applicable.

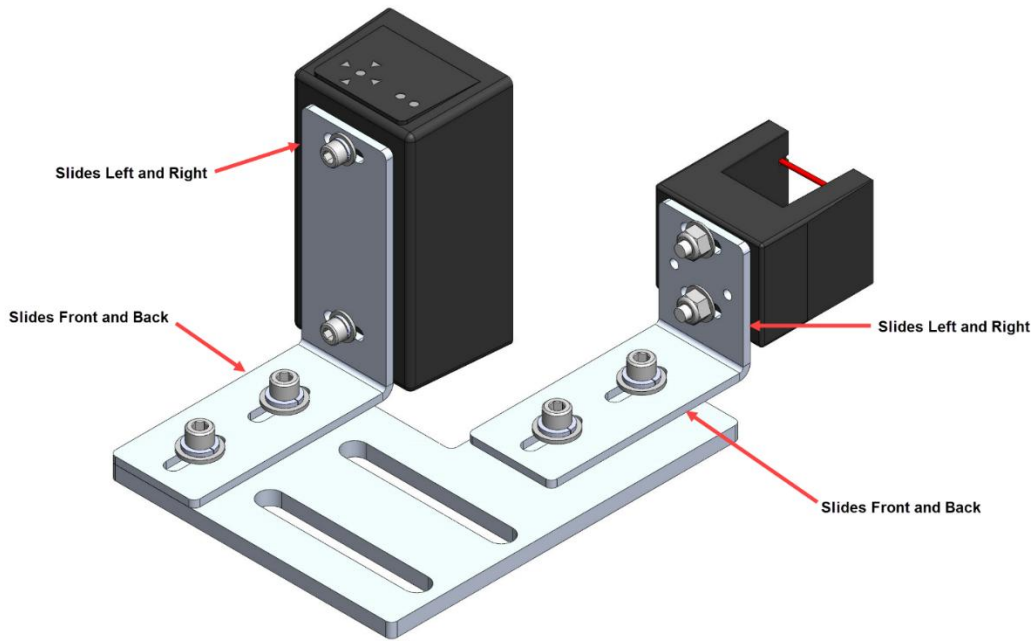

Figure 102: Sensor Array Assembly Adjustment

Power the APS camera via a RJ45 cable to the CT board so a red array can be seen on the tape to allow for alignment. If there is no red array on the tape, reset the power by disconnecting and reconnecting the RJ45 cable to the CT board CAT5 connector.

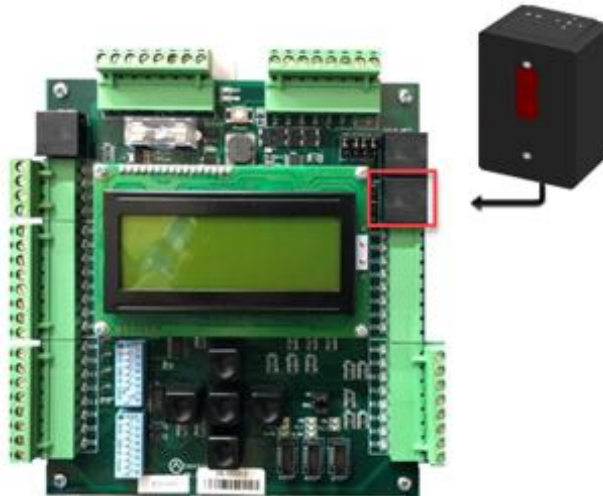

Figure 103: RJ45 Connection

Proceed on Inspection up and down the hoistway and adjust each tape guide clip to the correct in-line position with respect to the Sensor Array Assembly.

The camera powers up when the CT station is powered up.

### 1.8 Alignment

Alignment and Position Status LEDs are located on top of the optical sensor. These LEDs are used to align the sensor to the tape.

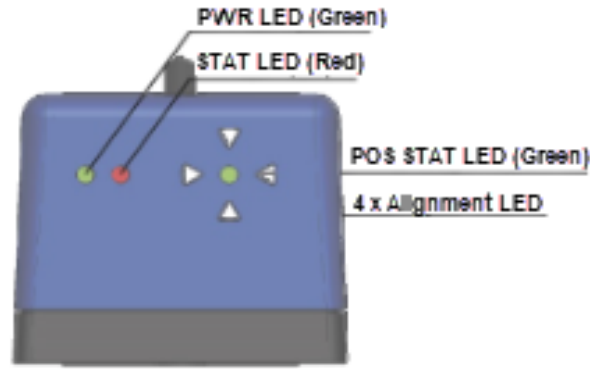

Figure 104: Optical Sensor LEDs

When the optical sensor needs to be aligned, the red arrow LEDs indicate which way to move the sensor.

The following procedure describes how to align the optical sensor.

1. Loosen the two mounting bolts on sensor base plate or sensor bracket to adjust the sensor position, as required.

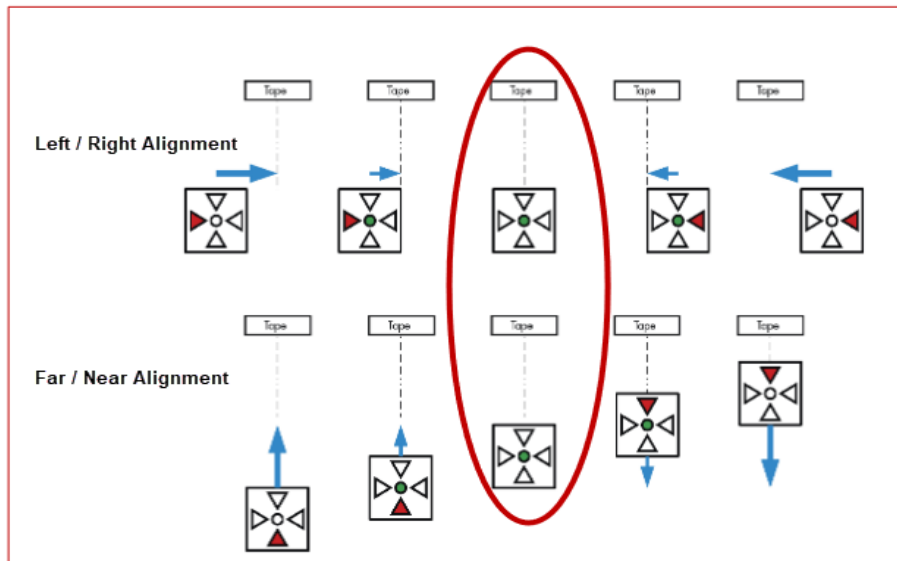

Figure 105: Alignment Arrows

2. Position the sensor according to the LEDs.
  - **Left / Right Alignment** – Using the direction arrows on top of the sensor, move the camera left or right until only the green POS STAT LED is on.
  - **Far / Near Alignment** – Using the directional arrows on top of the sensor, move the sensor closer to or further away from the tape until only the green POS STAT LED in on.
3. Once the sensor is aligned, tighten the two mounting bolts to the sensor base plate or sensor bracket as applicable.
4. Run the car on Inspection from terminal to terminal while watching the POS LED on top of the sensor.

5. Check whether the sensor is aligned with the tape for the entire length of travel.
  - i. If the sensor is aligned, the process ends.
  - ii. If the sensor is not aligned, go to step 1.

**NOTE:** as the car runs up and down the hoistway, the red alignment arrow LEDs may flash on and off. This is OK if the center green LED stays on.

## 2 Short Floor

In cases where there is a short floor distance (6 inches or less) between the front and rear openings, a secondary door zone blade should be installed to the other side of the primary door zone blade.

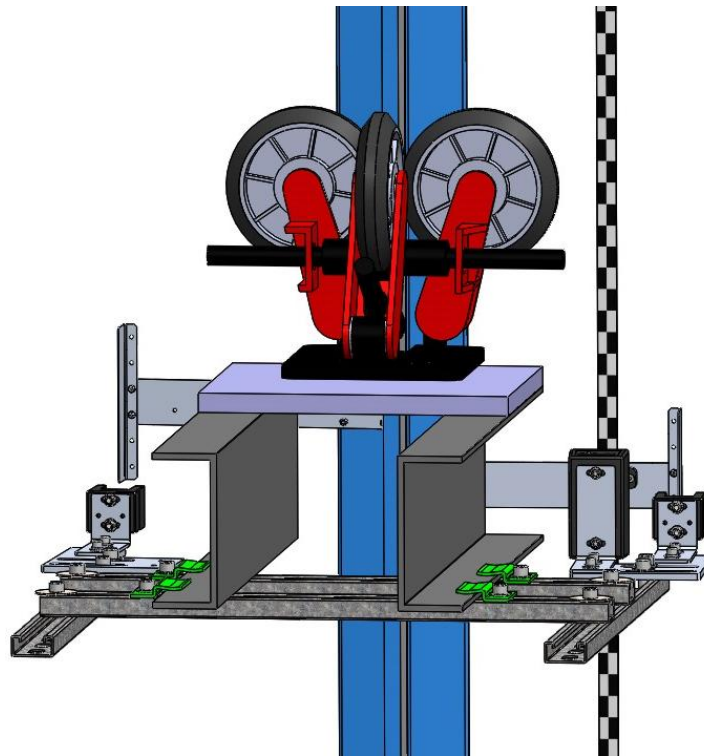

Figure 106: Dual Door Zone Blade & Reader (I)

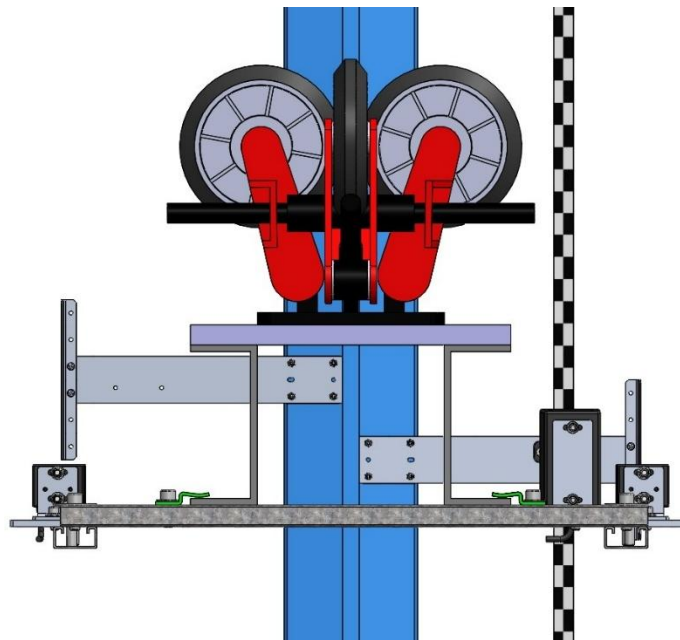

Figure 107: Dual Door Zone Blade & Reader (II)

### 3 NEMA 4 Landing System

The Smartrise NEMA 4 Landing System tracks elevator position with high precision and superior reliability. The position is read from a coded magnetic strip that is guided through the position sensor. The position sensed from the magnetic strip is contact free. The door zone sensor is contact-less.

The advantage of using the Smartrise NEMA 4 Landing system is that there is no need for alignment or contrast monitoring.

The Smartrise NEMA 4 Landing System consists of the following:

- Proximity Sensor Assembly
- Coded Magnetic Tape
- Mounting Assembly
- Guide with Sensor Detector

#### 3.1 Proximity Sensor Assembly

The magnetic proximity sensor in the Sensor Assembly reads the Smartrise Door Zone 6” magnetic strips. These sensors are non-latching. The magnets are installed next to the central protruding part of the guide rail.

**NOTE (Short Floor!):** In cases where there is a short floor distance (6 inches or less) between the front and rear openings, a secondary door zone sensor should be installed to the other side of the primary door zone sensor.

The Proximity Sensor Assembly consist of the following:

- Right Angle Mounting Bracket
- Cable
- Proximity Sensor

The following procedure describes how to assemble the Proximity Sensor Assembly.

1. Secure one nut onto the proximity sensor.
2. Slide the proximity sensor through the right-angle mounting bracket.
3. Secure the other nut onto the proximity sensor.



Figure 108: Proximity Sensor Assembly

When installing the Proximity Sensor Assembly, the distance of the sensor head to the magnet should be up to one inch.

Below is an example of how the Proximity Sensor Assembly can be mounted.

**NOTE:** The sensor can be mounted as needed.



Figure 109: Mounting Proximity Sensor Assembly (Example)

After the Sensor Assembly has been mounted, wire the Sensor Assembly to the Car Top. See the Controller +CTC sheet for wiring information.

## 3.2 Installation

The Safe Magnetic Absolute Sensor Assembly is installed using the mounting kit supplied by ELGO. Refer to the **ELGO Operating Manual** on how to install the Assembly.

### 3.2.1 Mounting Magnetic Tape in the Hoistway

The magnetic tape is to be mounted to the top and bottom of the hoistway. Verify the magnetic tape has the magnetic side facing the sensor and has the arrows on the tape facing the top of the hoistway. Refer the **ELGO Operating Manual** on how to install the magnetic tape along the guide rail and spring.

### 3.2.2 Mounting the Sensor to the Car

The sensor must be mounted to the car. The sensor must be positioned upwards towards the top of the hoistway during installation. Refer to the **ELGO Operating Manual** on how to mount the sensor.

Follow these steps to attach the mounting bracket to the sensor:

1. Insert two sets of nuts into each groove of the sensor.
2. Line up the nuts to the holes within the placement of the bracket on the sensor.
3. Secure the bracket to the sensor using the two sets of screws and lock washers.

**NOTE:** Responsibility for determining the orientation of the mounting bracket relative to the sensor and securing the mounting bracket to the car lies with the installer.

### 3.2.3 Install Magnetic Tape Through Sensor

The sensor reads the positioning information from the magnetic tape. The magnetic tape is a special stainless steel tape that provides absolute positioning information.

**⚠ WARNING**

**THE TAPE EDGE IS SHARP. CUT-PROOF GLOVES MUST BE WORN WHILE HANDLING THE TAPE.**



Figure 110: Gloves Required

The tape consists of a steel side and a magnetized side. When installing the magnetic tape through the tape guide, the steel side of the tape must touch the guide.

There are two ways to install the magnetic tape through the tape guide:

1. Feed the tape from one end of the tape through the tape guide to the other end.
2. Remove the cotter pin.
  - i. Remove the cotter pin from the channel.
  - ii. Remove tape guide.

- iii. Place tape on sensor housing.
- iv. Reinstall tape guide.
- v. Reinstall cotter pin.

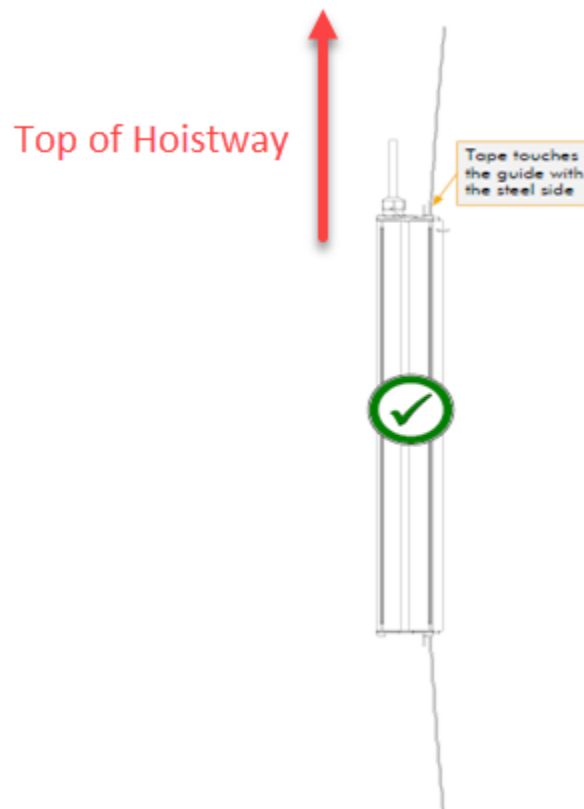

Figure 111: Magnetic Tape Installation<sup>2</sup>

See the **ELGO Operating Manual** for proper tape installation.

### 3.3 LEDs

There are three LEDs on the sensor (yellow, green, and red). Depending upon the input, each of the LEDs determine if the landing system is working properly or if an error has occurred. See the **ELGO Operating Manual** for the definition of each LED condition.

---

See ELGO Operating Manual LIMAX33 RED Safe Magnetic Absolute Shaft Information System

*Page intentionally left blank.*

---

# **NEW BOARD INSTALLATION**

---

## 1 Overview

If a board becomes mechanically or electrically faulty, it must be replaced. The configured parameters (e.g., timers, learned floors) can be retained after the board is replaced.

Before proceeding, verify that the replacement boards have the correct version programmed.

## 2 Retain Parameters for a Replaced MR Board

This procedure outlines the steps to transfer parameters from the CT board to a newly replaced MR board.

1. Turn **OFF** power to the controller.
2. Install the new MR (SRU) board and reconnect all terminal connectors. Keep group connections **OFF** until the synchronization process is complete.
3. Turn **ON** DIP switches **B5** and **A7**.
4. Restore power to the controller.
5. Upon startup, the MR board will display “**Sync In Progress**”, and the car will enter **Out of Service** mode.
6. When synchronization is complete, the MR board will display “**Sync Complete**”.
7. Turn **OFF** power to the controller.
8. Turn **OFF** DIP switches **B5** and **A7**.
9. Restore power. The car should now return to Normal operation.

## 3 Retain Parameters for a Replaced CT or COP Board

This procedure outlines how to transfer parameters from the MR board to a newly replaced CT or COP board.

1. Turn **OFF** power to the controller.
2. Disconnect all connectors and remove the CT or COP board.
3. Install the new CT or COP board and reconnect all terminals. Ensure that all DIP switches are set correctly.
4. Set the CT/COP selector switch to match the type of board being replaced. This switch is located in the upper-right corner of the board.
5. Remove lockout/tagout and restore power to the controller. The synchronization will begin automatically. Parameters are continuously compared across all three boards using checksum validation. “**Sync In Progress**” will not be displayed during this process.
6. Once synchronization is complete, the CT or COP board will resume normal operation with all parameters retained.

---

# **CONTROLLER MENU STRUCTURE**

---

# 1 Menu Structures

The following figures display the menu options available on the Hydro:Evolved system.

The menu structure is designed so that selecting a specific option from a set of menus leads to a submenu with additional inputs or settings.

## 1.1 Status

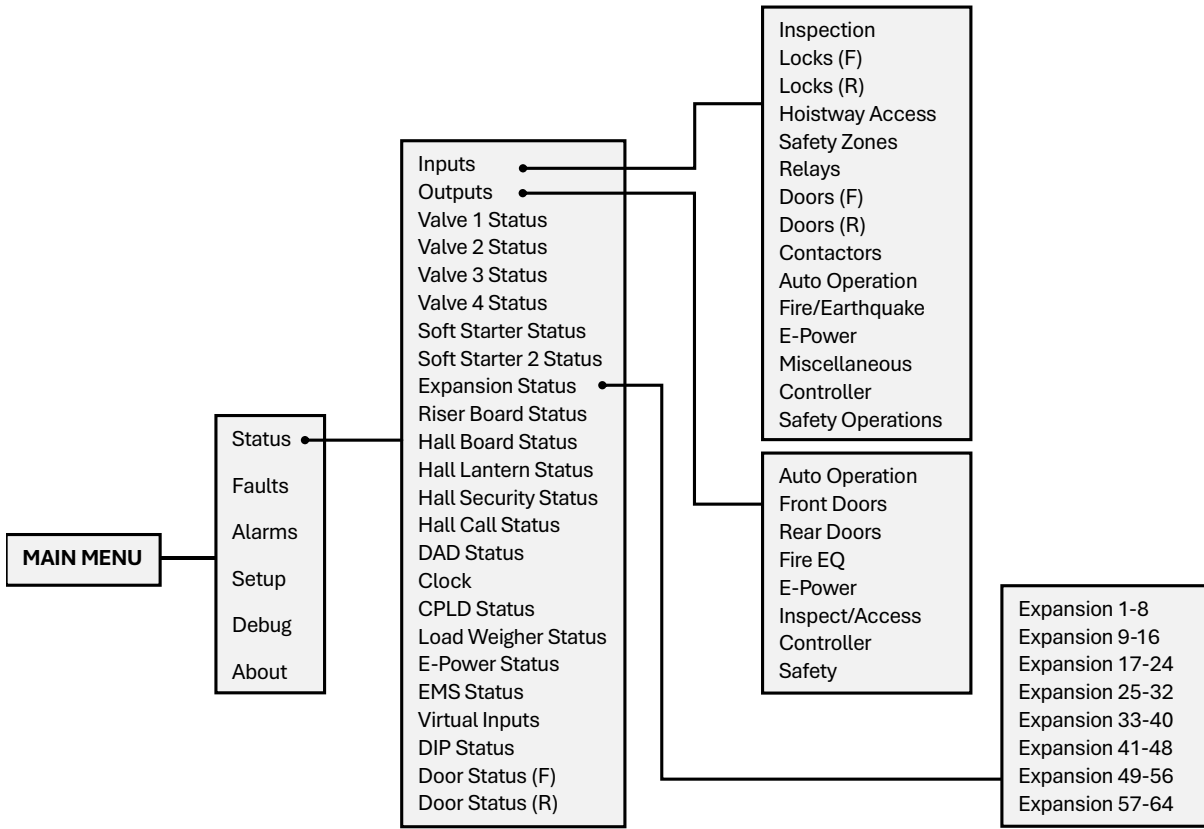

Figure 112: Status – Inputs, Outputs, and Expansion Status Menus

The table below lists the Status – Input, Outputs, and Expansion Status menu structures.

Table 46: Status – Inputs, Outputs, and Expansion Status Menu Structures

Menu	Description
<b>MAIN MENU</b>	
<b>Status</b>	Displays information about the current state of the controller
<b>Status</b>	
<b>Inputs</b>	Shows the status of all programmed inputs to the MR board
<b>Outputs</b>	Shows the status of all programmed outputs from the MR board
<b>Valve 1 Status</b>	Shows the status of Valve board
<b>Valve 2 Status</b>	Shows the status of the second Valve board
<b>Valve 3 Status</b>	Shows the status of the third Valve board
<b>Valve 4 Status</b>	Shows the status of the fourth Valve board

<b>Soft Starter Status</b>	Shows the status of the soft starter
<b>Soft Starter 2 Status</b>	Shows the status of the secondary soft starter
<b>Expansion Status</b>	Shows communication status for a group of Expansion boards
<b>Riser Board Status</b>	Shows the status of the Riser board
<b>Hall Board Status</b>	Shows communication status for all Hall boards
<b>Hall Lantern Status</b>	Shows communication status for all Hall Lantern boards
<b>Hall Security Status</b>	Shows communication status for all Hall Security boards
<b>Inputs</b>	
<b>Inspection</b>	Shows the status of inspection related inputs
<b>Locks (F) &amp; (R)</b>	Shows the status of all locks
<b>Hoistway Access</b>	Shows the status of all hoistway accesses
<b>Safety Zones</b>	Shows the status of safety inputs
<b>Relays</b>	Shows the status of all active relays
<b>Doors (F) &amp; (R)</b>	Shows the status of all door operator signals
<b>Contactors</b>	Shows the status of all contactor monitoring signals
<b>Auto Operation</b>	Shows the status inputs under auto operation category
<b>Fire/Earthquake</b>	Shows the status of fire/earthquake inputs
<b>E-Power</b>	Shows the status E-Power inputs
<b>Miscellaneous</b>	Shows the status of various other inputs
<b>Outputs</b>	
<b>Auto Operation</b>	Shows the outputs that are in auto operation
<b>Front Doors</b>	Shows the status of front door outputs
<b>Rear Doors</b>	Shows the status of rear door outputs
<b>Fire EQ</b>	Shows the status of fire/earthquake outputs
<b>E-Power</b>	Shows the status of E-Power outputs
<b>Inspect/ Access</b>	Shows the status of inspection outputs
<b>Controller</b>	Shows the status of control outputs
<b>Safety</b>	Shows the status of safety outputs
<b>Expansion Status</b>	
<b>Expansion 1-8</b>	Shows the communication status for Expansion group 1
<b>Expansion 9-16</b>	Shows the communication status for Expansion group 2
<b>Expansion 17-24</b>	Shows the communication status for Expansion group 3
<b>Expansion 25-32</b>	Shows the communication status for Expansion group 4
<b>Expansion 33-40</b>	Shows the communication status for Expansion group 5
<b>Expansion 41-48</b>	Shows the communication status for Expansion group 6
<b>Expansion 49-56</b>	Shows the communication status for Expansion group 7
<b>Expansion 57-64</b>	Shows the communication status for Expansion group 8

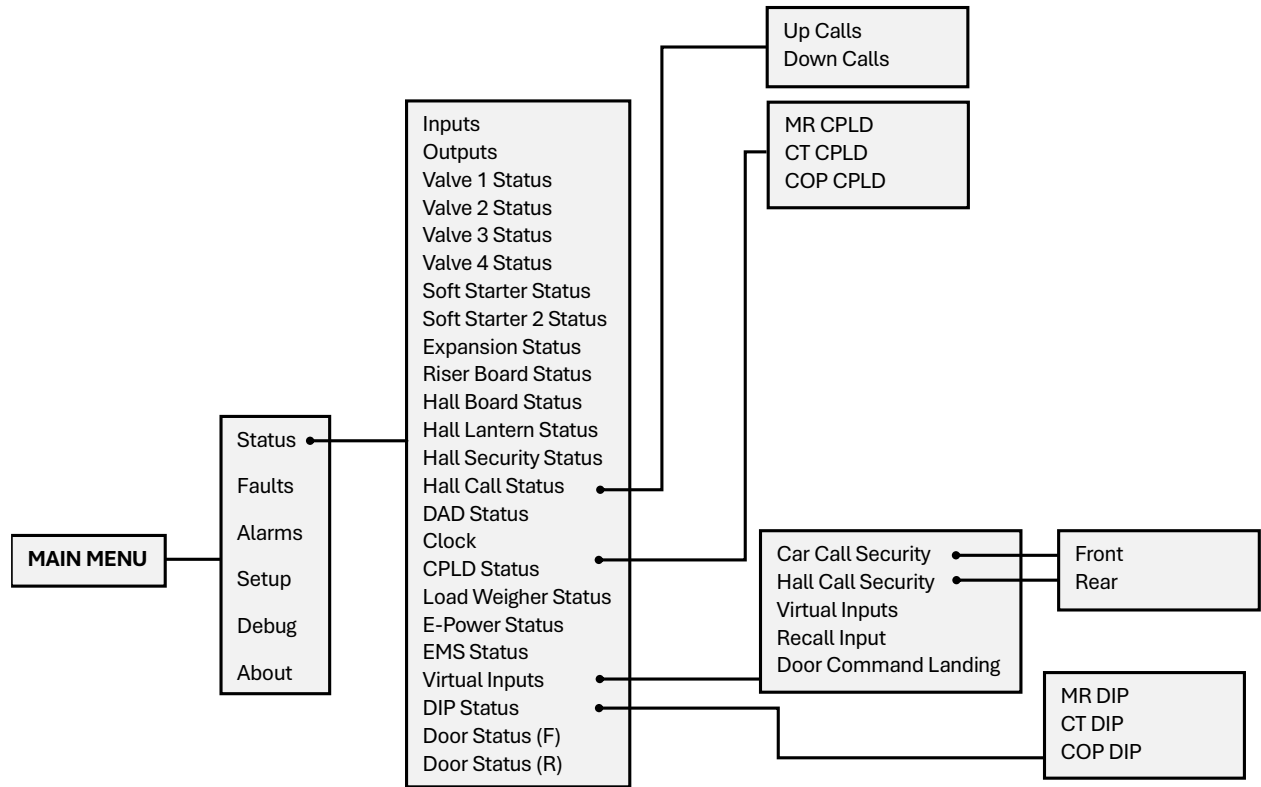

Figure 113: Status – Hall Call Status, CPLD Status, Virtual Inputs, and DIP Status Menus

The table below lists the Status – Hall Call Status, CPLD Status, Virtual Inputs, and DIP Status menu structures.

Table 47: Status – Hall Call Status, CPLD Status, Virtual Inputs, and DIP Status Menu Structures

Menu	Description
<b>Status</b>	
<b>Hall Call Status</b>	Shows the status of hall calls
<b>DAD Status</b>	Shows the status of DAD unit
<b>Clock</b>	View current clock setting on the system
<b>CPLD Status</b>	Shows the status of CPLDs
<b>E-Power Status</b>	Shows the status of emergency power
<b>EMS Status</b>	Shows the status of emergency medical service
<b>Virtual Inputs</b>	Shows the status of all inputs via remote access
<b>DIP Status</b>	Shows the status of the DIP switches
<b>Door Status (F)</b>	Shows the input status of a front door
<b>Door Status (R)</b>	Shows the input status of a rear door
<b>Hall Call Status</b>	
<b>Up Calls</b>	Shows list of latched up hall calls per car
<b>Down Calls</b>	Shows list of latched down hall calls per car
<b>CPLD Status</b>	
<b>MR CPLD</b>	Shows MR current CPLD version, activity, and faults
<b>CT CPLD</b>	Shows CT current CPLD version, activity, and faults
<b>COP CPLD</b>	Shows COP current CPLD version, activity, and faults
<b>Virtual Inputs</b>	
<b>Car Call Security</b>	Shows status of car call security map set remotely

<b>Hall Call Security</b>	Shows status of hall call security map set remotely
<b>Virtual Inputs</b>	Shows the status of variety of inputs set remotely by remote monitoring system
<b>Recall Input</b>	Shows the recall floor and door that opens when remote recall to floor input is asserted
<b>Door Command Landing</b>	Shows the status of a door to a designated landing
<b>DIP STATUS</b>	
<b>MR DIP</b>	Shows the status of MR DIP switches that are On
<b>CT DIP</b>	Shows the status of CT DIP switches that are On
<b>COP DIP</b>	Shows the status of COP DIP switches that are On

## 1.2 Faults and Alarms

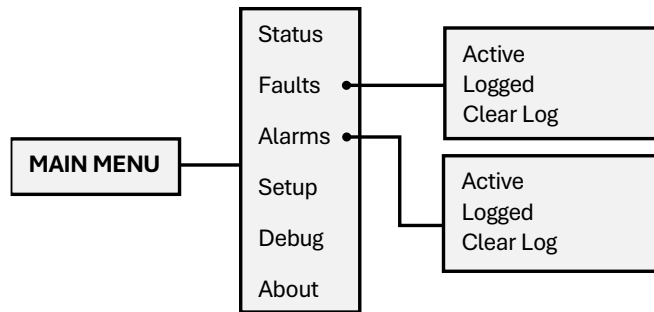

Figure 114: Faults and Alarms Menu

The table below lists the Faults and Alarms menu structures.

Table 48: Faults and Alarms Menu Structures

Menu	Description
<b>MAIN MENU</b>	
<b>Faults</b>	Allows the user to access Fault data
<b>Alarms</b>	Allows the user to access Alarm data
<b>Faults</b>	
<b>Active</b>	Displays current active faults that are preventing the car from running
<b>Logged</b>	Displays the 32 latest faults stored in the systems non-volatile memory with the most recent faults at the top
<b>Clear Log</b>	Clears the fault log history
<b>Alarms</b>	
<b>Active</b>	Displays current active alarms
<b>Logged</b>	Displays the 32 latest faults stored in the systems non-volatile memory with the most recent faults at the top
<b>Clear Log</b>	Clears the alarm log history

### 1.3 Setup

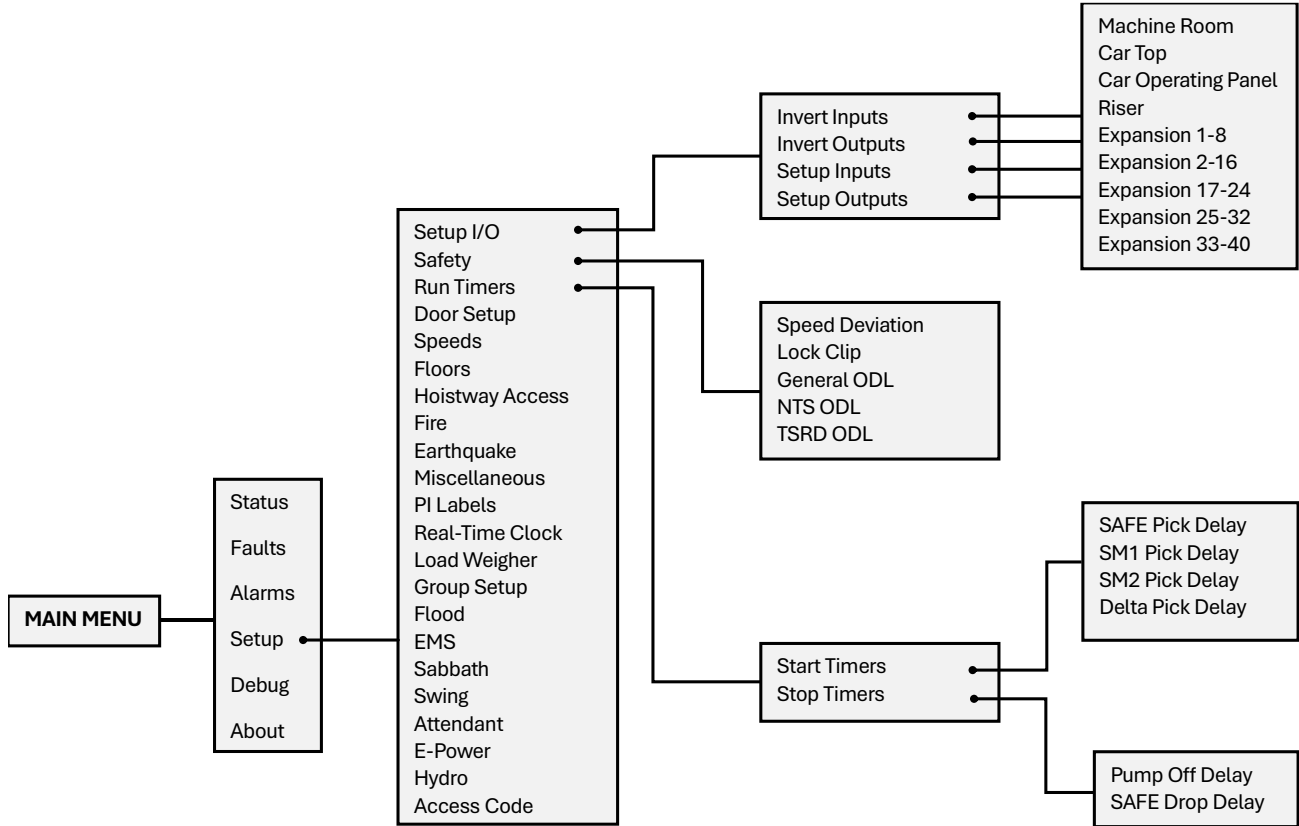

Figure 115: Setup – Setup I/O, Safety, and Run Timers Menus

The table below lists the Setup – Setup I/O, Safety, and Run Timers menu structures.

Table 49: Setup – Setup I/O, Safety, and Run Timers Menu Structures

Menu	Description
<b>MAIN MENU</b>	
<b>Setup</b>	Allows the user to setup the elevator configuration
<b>Setup</b>	
<b>Setup I/O</b>	Configure inputs and outputs
<b>Safety</b>	Allows the user to adjust safety related functions
<b>Run Timers</b>	Adjust start sequence and stop sequence timers
<b>Setup I/O</b>	
<b>Invert Inputs</b>	Invert selected inputs
<b>Invert Outputs</b>	Invert selected outputs
<b>Setup Inputs</b>	Assign inputs
<b>Setup Outputs</b>	Assign outputs
<b>Invert Inputs</b>	
<b>Machine Room</b>	Change state of input to the MR board
<b>Car Top</b>	Change state of input to the CT board
<b>Car Operating Panel</b>	Change state of input to the COP board
<b>Riser</b>	Change state of input to the Riser board
<b>Expansion 1-8</b>	Change state of input to the Expansion 1-8 boards

Menu	Description
<b>Expansion 9-16</b>	Change state of input to the Expansion 9-16 boards
<b>Expansion 17-24</b>	Change state of input to the Expansion 17-24 boards
<b>Expansion 25-32</b>	Change state of input to the Expansion 25-32 boards
<b>Expansion 33-40</b>	Change state of input to the Expansion 33-40 boards
<b>Invert Outputs</b>	
<b>Machine Room</b>	Change state of output to the MR board
<b>Car Top</b>	Change state of output to the CT board
<b>Car Operating Panel</b>	Change state of output to the COP board
<b>Riser</b>	Change state of output to the Riser board
<b>Expansion 1-8</b>	Change state of output to the Expansion 1-8 boards
<b>Expansion 9-16</b>	Change state of output to the Expansion 9-16 boards
<b>Expansion 17-24</b>	Change state of output to the Expansion 17-24 boards
<b>Expansion 25-32</b>	Change state of output to the Expansion 25-32 boards
<b>Expansion 33-40</b>	Change state of output to the Expansion 33-40 boards
<b>Setup Inputs</b>	
<b>Machine Room</b>	Assign inputs to the MR board
<b>Car Top</b>	Assign inputs to the CT board
<b>Car Operating Panel</b>	Assign inputs to the COP board
<b>Riser</b>	Assign inputs to the Riser board
<b>Expansion 1-8</b>	Assign inputs to the Expansion 1-8 boards
<b>Expansion 9-16</b>	Assign inputs to the Expansion 9-16 boards
<b>Expansion 17-24</b>	Assign inputs to the Expansion 17-24 boards
<b>Expansion 25-32</b>	Assign inputs to the Expansion 25-32 boards
<b>Expansion 33-40</b>	Assign inputs to the Expansion 33-40 boards
<b>Setup Outputs</b>	
<b>Machine Room</b>	Assign outputs from the MR board
<b>Car Top</b>	Assign outputs from the CT board
<b>Car Operating Panel</b>	Assign outputs from the COP board
<b>Riser</b>	Assign outputs from the Riser board
<b>Expansion 1-8</b>	Assign outputs from the Expansion 1-8 boards
<b>Expansion 9-16</b>	Assign outputs from the Expansion 9-16 boards
<b>Expansion 17-24</b>	Assign outputs from the Expansion 17-24 boards
<b>Expansion 25-32</b>	Assign outputs from the Expansion 25-32 boards
<b>Expansion 33-40</b>	Assign outputs from the Expansion 33-40 boards
<b>Safety</b>	
<b>Speed Deviation</b>	Adjust speed deviation options
<b>Lock Clip</b>	The amount of time the controller disregards an open hall lock. This prevents intermittent interlock faults and for safety reasons, this timer should not exceed five seconds
<b>General ODL</b>	General overspeed debounce limit
<b>NTS ODL</b>	NTS overspeed debounce limit
<b>TSRD ODL</b>	TSRD overspeed debounce limit
<b>Run Timers</b>	
<b>Start Timers</b>	Timers used for motion start sequence
<b>Stop Timers</b>	Timers used for motion stop sequence
<b>Start Timers</b>	
<b>SAFE Pick Delay</b>	Sets the delay between activating the MR SAFE output and activating the primary start motor output when moving in the up direction.

Menu	Description
	Sets delay between activating the SAFE output and activating the valve when moving in the down direction.
<b>SM1 Pick Delay</b>	Sets delay between activating the primary start motor output and activating the valve when moving in the up direction.
<b>SM2 Pick Delay</b>	Sets delay between activating the secondary start motor output and activating the valve when moving in the up direction.
<b>Delta Pick Delay</b>	Sets delay between activating the Delta output and activating the valve outputs
<b>SAFE Pick Delay</b>	Sets the delay between activating the MR SAFE output and activating the primary start motor output when moving in the up direction. Sets delay between activating the SAFE output and activating the valve when moving in the down direction.
Stop Timers	
<b>Pump Off Delay</b>	Sets delay between how long the pump motor continues to run after closing the Up valves
<b>Safe Drop Delay</b>	Sets delay between the time between deactivating the pump motor and turning off the MR-SAFE output

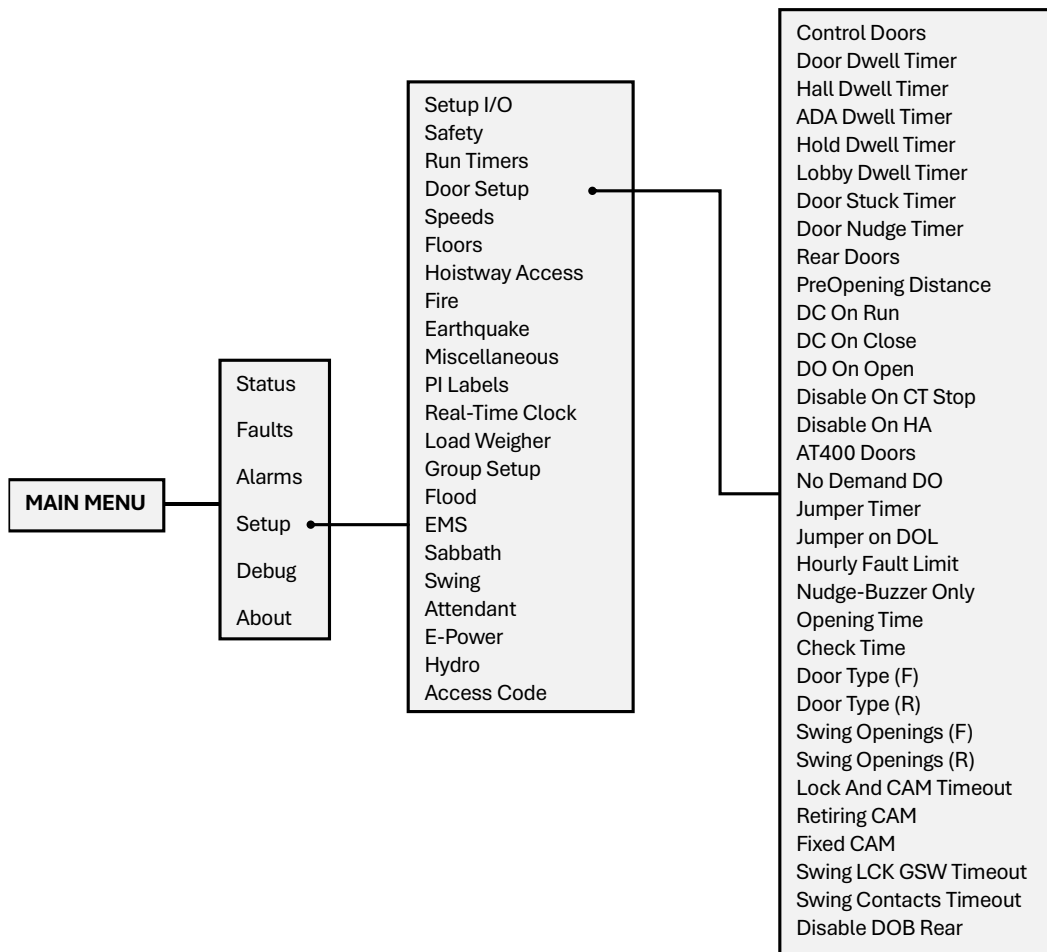

Figure 116: Setup - Door Setup Menu

The table below lists the Setup – Door Setup menu structure.

Table 50: Setup – Door Setup Menu Structure

Menu	Description
<b>Setup</b>	
<b>Door Setup</b>	Configure door parameters
<b>Door Setup</b>	
<b>Control Doors</b>	Allows for manually opening and closing the doors through the UI
<b>Door Dwell Timer</b>	Time car doors remains open when answer car calls
<b>Hall Dwell Timer</b>	Time car doors remain open when answering hall calls
<b>ADA Dwell Timer</b>	Time car doors remain open when answering ADA calls
<b>Hold Dwell Timer (1 sec)</b>	Time car doors remain open when responding to door hold button requests
<b>Lobby Dwell Timer</b>	Time car doors remain open when answering lobby calls
<b>Door Stuck Timer (1 sec)</b>	Time limit for a door to complete an opening or closing request before faulting
<b>Door Nudge Timer (1 sec)</b>	Time doors spend trying to close before transitioning to nudging which ignores photoeye. If set to zero, nudging is disabled.
<b>Rear Doors</b>	Enable or disable rear doors
<b>PreOpening Distance (.019”)</b>	The distance from a floor to start preopening doors. If zero, preopening is disabled.
<b>DC On Run</b>	Activates door close output while in motion
<b>DC On Close</b>	Activates door close output while the doors are in closed state
<b>DO On Open</b>	Activates door open output while the doors are in open state
<b>Disable On CT Stop</b>	When set ON, door outputs are suppressed when the CT Stop switch is active
<b>Disable On HA</b>	When set ON, door outputs are suppressed when on hoistway access inspection
<b>AT400 Doors</b>	When set to On, the option for AT400 door operator is enabled (if applicable).
<b>No Demand DO</b>	Doors remain open while the car is idle
<b>Jumper Timer (100 ms)</b>	Timer for jumper on Gate switch (F98/F107) and jumper on lock (F99/F108) faults. This value is added to a minimum timeout of 1.6 seconds.
<b>Jumpers On DOL</b>	When set to ON, detects jumper on GSW due to a discrepancy between GSW and DOL signal. When set to OFF, detects jumper on GSW due to a discrepancy between GSW and inverted DCL signal.
<b>Hourly Fault Limit</b>	The number of door faults allowed within 1-hour window before the car goes out of service. If the car goes out of service, it will remain out of service until the hour window elapses. If set to zero, this feature is disabled.
<b>Nudge – Buzzer Only</b>	When set ON during nudging, the NDG output is suppressed and only the buzzer sounds.
<b>Opening Time (100ms)</b>	The estimated time it takes the doors to go from fully closed to fully open. This value is learned after performing a run with preflight disabled (01-0064) and the learn opening time bit is ON (01-0165). This can help improve dwell time delays when preflight is on. If set to zero, this option is disabled.
<b>Check Time (100ms)</b>	Sets the time the car doors must be seen as safe before the car is allowed to start a run on automatic operation. Time is set in 100 ms counts. If zero, defaults to 300 ms.
<b>Door Type (F)</b>	Sets front door type
<b>Door Type (R)</b>	Sets rear door type
<b>Swing Opening (F)</b>	Enable or disable swing operation for each front door landing
<b>Swing Opening (R)</b>	Enable or disable swing operation for each rear door landing

Menu	Description
<b>Lock And CAM Timeout</b>	Sets the timeout which accounts for the delay between CAM activation and locks being made for manual doors. The units are in 100 ms counts. If set to zero, value defaults to 4 seconds.
<b>Retiring CAM</b>	When set to ON, the CAM output controls hall interlocks. Otherwise, interlocks are controlled by the door operator.
<b>Fixed CAM</b>	When set to ON, the door has a fixed hall CAM. The car is allowed to start a run without hall locks (hall closed contacts still required). The car is allowed to move up to 2 feet without locks before faulting.
<b>Swing LCK GSW Timeout</b>	Sets the timeout between GSW and locks. If value is zero, timeout is set to 500 ms. The units are in seconds.
<b>Swing Contacts Timeout</b>	Sets the timeout between CAM being energized and closed contacts being made. If value is zero, timeout is set to 500 ms. The units are in seconds.
<b>Disable DOB Rear</b>	When set to ON, the rear door on bottom floor is disabled

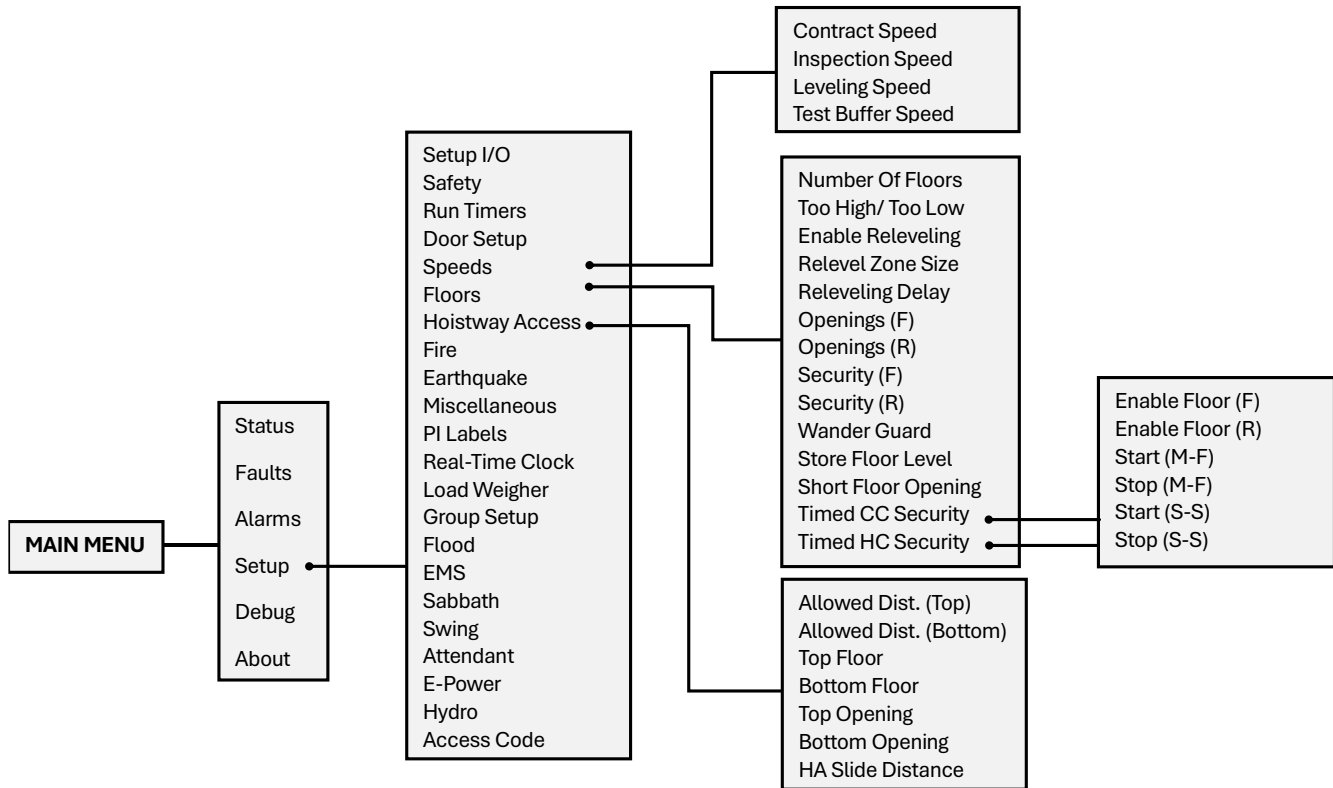

Figure 117: Setup – Speeds, Floors, and Hoistway Access Menus

The table below lists the Setup –Speeds, Floors and Hoistway Access menu structures.

Table 51: Setup – Speeds, Floors and Hoistway Access Menu Structures

Menu	Description
<b>Setup</b>	
<b>Speeds</b>	Configure speed parameters
<b>Floors</b>	Setup floor related parameters
<b>Hoistway Access</b>	Hoistway access setup menu
<b>Speeds</b>	

Menu	Description
<b>Contract Speed</b>	Contract Speed
<b>Inspection Speed</b>	Inspection Speed
<b>Leveling Speed</b>	Leveling Speed
<b>Test Buffer Speed</b>	Test Buffer Speed
<b>Floors</b>	
<b>Number Of Floors</b>	Allows for setting the number of floors within the building
<b>Too High/ Too Low</b>	Used to adjust the learned position of the floor when setting floor levels
<b>Enable Releveling</b>	Enables releveling operation
<b>Relevel Zone Size (.02")</b>	Sets the size of the releveling zone (dead zone)
<b>Relevel Delay</b>	The time the controller waits before engaging a Relevel command while in a door zone and outside the dead zone
<b>Openings (F)</b>	Allows for setting the floors the front door opens
<b>Openings (R)</b>	Allows for setting the floors the rear door opens
<b>Security (F)</b>	Allows for setting the security parameters for front door
<b>Security (R)</b>	Allows for setting the security parameters for rear door
<b>Wander Guard</b>	Allows for setting the wander guard feature for any floor
<b>Store Floor Level</b>	Sets the position of the short floor level
<b>Short Floor Opening</b>	Sets overlapping door zones (short floors)
<b>Timed CC Security</b>	Allows for setting car call security for specific times
<b>Timed HC Security</b>	Allows for setting hall call security for specific times
<b>Timed CC Security</b>	
<b>Enable Floor (F)</b>	Allows for enabling timed security for front openings
<b>Enable Floor (R)</b>	Allows for enabling timed security for rear openings
<b>Start (M-F)</b>	Sets the time that floor access is denied during M-F
<b>Stop (M-F)</b>	Sets the time that floor access is resumed on M-F
<b>Start (S-S)</b>	Sets the time that floor access is denied during S-S
<b>Stop (S-S)</b>	Sets the time that floor access is resumed on S-S
<b>Timed HC Security</b>	
<b>Enable Floor (F)</b>	Allows for enabling timed security for front openings
<b>Enable Floor (R)</b>	Allows for enabling timed security for rear openings
<b>Start (M-F)</b>	Sets the time that floor access is denied during M-F
<b>Stop (M-F)</b>	Sets the time that floor access is resumed on M-F
<b>Start (S-S)</b>	Sets the time that floor access is denied during S-S
<b>Stop (S-S)</b>	Sets the time that floor access is resumed on S-S

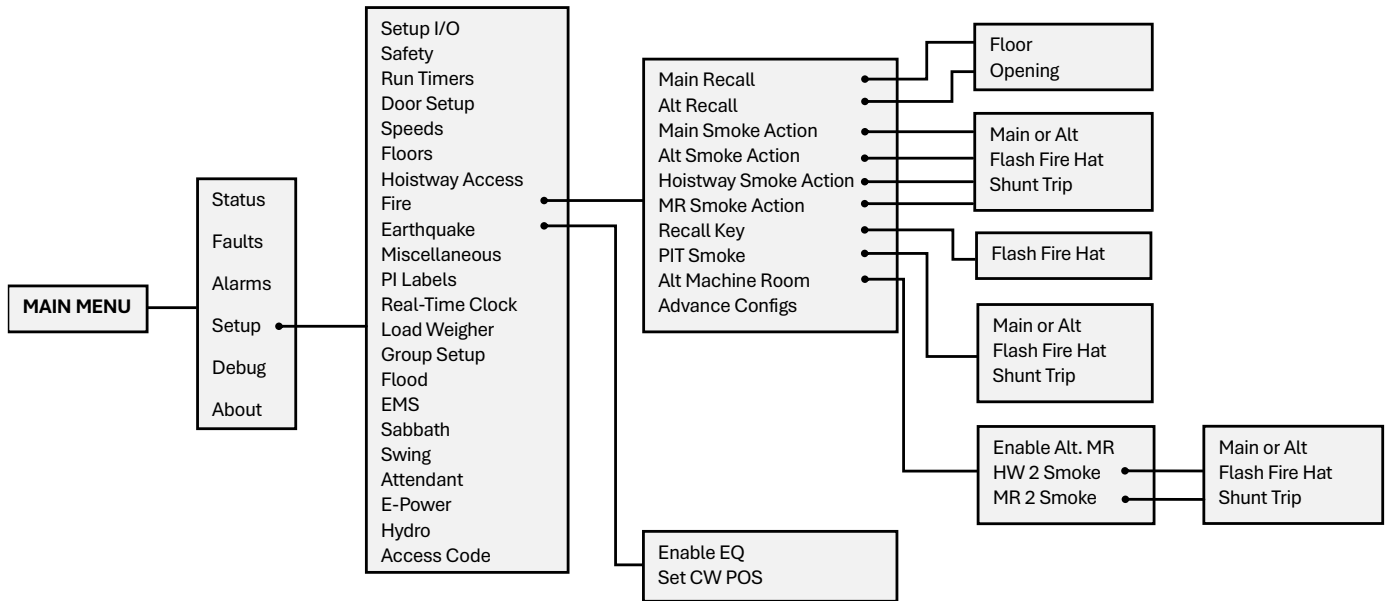

Figure 118: Setup – Fire, and Earthquake Menus

The table below lists the Setup – Fire and Earthquake menu structures.

Table 52: Setup – Fire and Earthquake Menu Structures

Menu	Description
<b>Setup</b>	
<b>Fire</b>	Fire operation setup menu
<b>Earthquake</b>	Earthquake operation setup menu
<b>Fire</b>	
<b>Main Recall</b>	Sets the main recall floor
<b>Alt Recall</b>	Sets the designated alternate recall floor
<b>Main Smoke Action</b>	Main smoke options
<b>Alt Smoke Action</b>	Alternate smoke options
<b>Hoistway Smoke Action</b>	Hoistway smoke options
<b>MR Smoke Action</b>	Machine room smoke options
<b>Recall Key</b>	Key to recall to service floor
<b>PIT Smoke</b>	Pit smoke options
<b>Alt Machine Room</b>	Secondary machine room smoke
<b>Advance Configs</b>	Additional fire features
<b>Main Recall</b>	
<b>Floor</b>	Sets the main fire recall floor. This value is zero based, so the bottom most floor is zero
<b>Opening</b>	Sets the main recall opening as front or rear
<b>Alt Recall</b>	
<b>Floor</b>	Sets the alternate fire recall floor This value is zero based, so the bottom most floor is zero
<b>Opening</b>	Sets the main recall opening as front or rear
<b>Main Smoke</b>	
<b>Main or Alt</b>	Sets whether the elevator will recall to the main or alternate landing when the main smoke is active

Menu	Description
Flash Fire Hat	Flash fire hat when main smoke is active
Shunt Trip	Activates fire shunt output during Phase 1 recall if triggered by main smoke input
<b>Alt Smoke</b>	
Main or Alt	Sets whether the elevator will recall to the main or alternate landing when the alternate smoke is active
Flash Fire Hat	Flash fire hat when alternate smoke is active
Shunt Trip	Activates fire shunt output during Phase 1 recall if triggered by alternate smoke input
<b>Hoistway Smoke</b>	
Main or Alt	Sets whether the elevator will recall to the main or alternate landing when the hoistway smoke is active
Flash Fire Hat	Flash fire hat when hoistway smoke is active
Shunt Trip	Activates fire shunt output during Phase 1 recall if triggered by hoistway smoke input
<b>MR Smoke</b>	
Main or Alt	Sets whether the elevator will recall to the main or alternate landing when the machine room smoke is active
Flash Fire Hat	Flash fire hat when machine room smoke is active
Shunt Trip	Activates fire shunt output during Phase 1 recall if triggered by machine room smoke input
<b>Recall Key</b>	
Flash Fire Hat	Flash fire hat when recall key is turned to the ON position
<b>PIT Smoke</b>	
Main or Alt	Sets whether the elevator recalls to the main or alternate landing when the pit smoke is active
Flash Fire Hat	Flash fire hat when pit smoke is active
Shunt Trip	Activates fire shunt output during Phase 1 recall if triggered by pit smoke input
<b>Alt Machine Room</b>	
Enable Alt. MR	Enables alternate machine room fire operation setup menu
HW 2 Smoke	Alternate hoistway smoke options
MR 2 Smoke	Alternate machine room smoke options
<b>HW 2 Smoke</b>	
Main or Alt	Sets whether the elevator recalls to the main or alternate landing when alternate machine room smoke is active
Flash Fire Hat	Flash fire hat when alternate machine room smoke is active
Shunt Trip	Activates fire shunt output during Phase 1 recall if triggered by alternate machine room smoke input
<b>MR 2 Smoke</b>	
Main or Alt	Sets whether the elevator recalls to the main or alternate landing when the alternate machine room smoke is active
Flash Fire Hat	Flash fire hat when alternate machine room smoke is active
Shunt Trip	Activates fire shunt output during Phase 1 recall if triggered by alternate machine room smoke input
<b>Earthquake</b>	
Enable EQ	Enables earthquake options
Set CW POS	Set the CW midpoint position

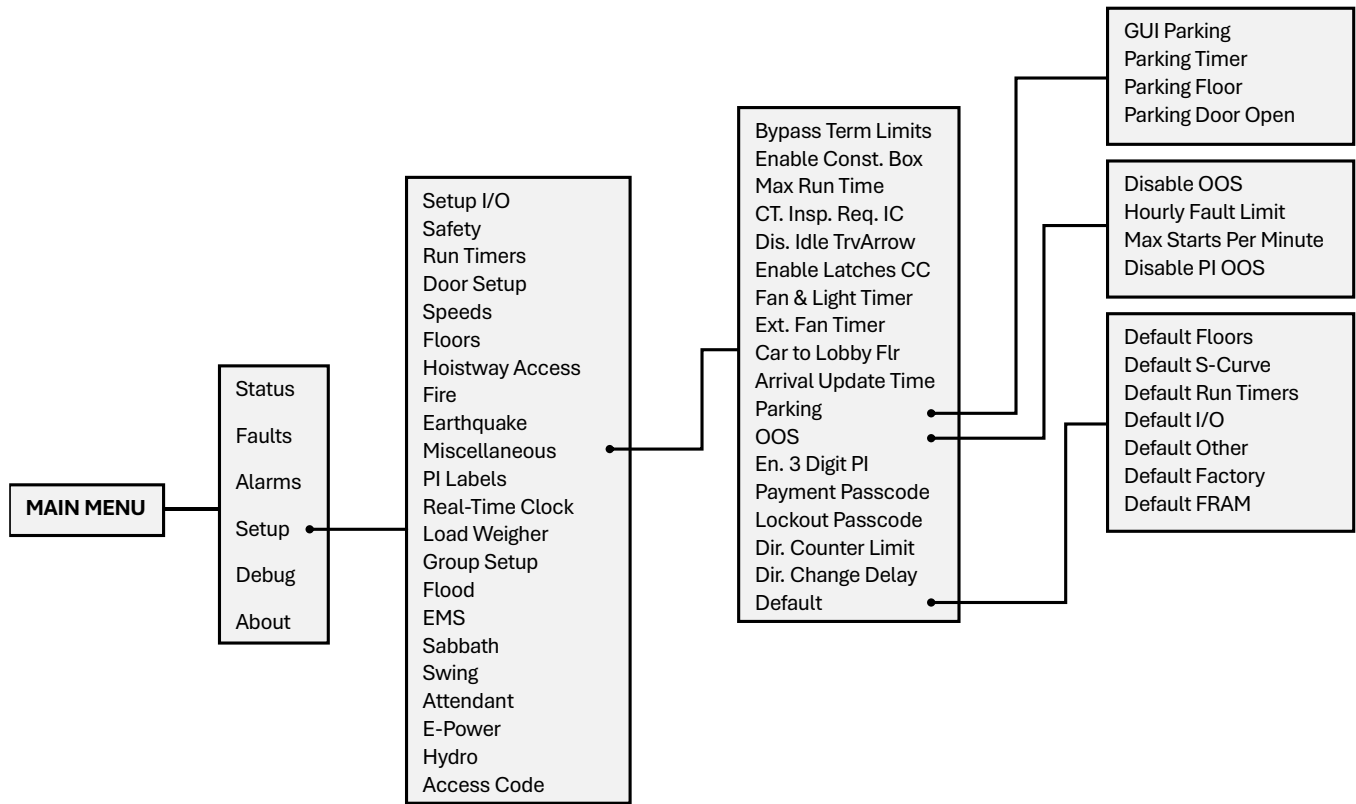

Figure 119: Setup – Miscellaneous Menu

The table below lists the Setup – Miscellaneous menu structures.

Table 53: Setup – Miscellaneous Menu Structures

Menu	Description
<b>Setup</b>	
<b>Miscellaneous</b>	Miscellaneous menu options
<b>Miscellaneous</b>	
<b>ByPass Term Limit</b>	Bypasses terminal limit faults. This option is automatically turned off when in automatic operation.
<b>Enable Const. Box</b>	Enable/Disable Construction Box. When enabled, onboard inspection buttons are ignored on construction operation and onboard inputs are used.
<b>Max Run Time</b>	Sets the max run time allowed in automatic operation before the car faults (F116). If set to zero, this fault is suppressed.
<b>CT. Insp. Req. IC</b>	Requires In-Car inspection to enable CT inspection
<b>Dis. IdleTrvArrow</b>	When set ON, CE travel arrows reflect the motion direction of the car. When set OFF, the arrows reflect the motion direction of the car and the arrival direction after a run.
<b>Enable Latches CC</b>	When set ON, car call security enable input latches a car call
<b>Fan &amp; Light Timer</b>	Sets the time the car may be idle before its fan and light output is turned off. If a longer timer is needed, the extended fan and light timer should be used instead. Units are in seconds.
<b>Ext. Fan Timer</b>	Extended fan and light timer

Menu	Description
<b>Car to Lobby Flr</b>	Sets the floor the car moves to when the car to lobby input is activated. This value is zero based.
<b>Arrival Update Time</b>	Sets the time before arriving at a floor to update arrival lantern outputs. If set to zero, arrival outputs updates when doors begin to open. Units are in seconds.
<b>Parking</b>	Parking options
<b>OOS</b>	Car out of service options
<b>En. 3 Digit PI</b>	Enables 3-digit PI
<b>Payment Passcode</b>	Controller passcode
<b>Lockout Passcode</b>	Sets the screen lockout code which restricts access to allowed elevator personnel
<b>Dir. Counter Limit</b>	Sets a limit on the number of trips done in the opposite direction. Once it is exceeded, the car will go into OOS Mode.
<b>Dir. Change Delay</b>	Sets the time to delay car direction changes. Allows time for passengers to enter their car calls. Units are in 1 second counts.
<b>Default</b>	Parameter default options
<b>Parking</b>	
<b>GUI Parking</b>	Enable GUI parking
<b>Parking Timer (1 sec)</b>	Sets the time it takes before an idle car is parked. If set to zero, parking is disabled.
<b>Parking Floor</b>	Floor the car parks at
<b>Parking Door Open</b>	Enables parking with doors open
<b>OOS</b>	
<b>Disable OOS</b>	Disables the controller from going out of service due to reoccurring faults
<b>Hourly Fault Limit</b>	Sets the number of faults allowed within a 1-hour window before the car goes out of service. If the car goes out of service, it remains out of service until the hour window elapses.
<b>Max Starts Per Minute</b>	Specifies how many times the car may attempt to start a run in automatic operation during a 1-minute window. If the controller attempts additional runs, the car goes out of service until the real-time clock increments to the next minute. Set this parameter to zero to disable the feature.
<b>Disable PI OOS</b>	When set ON, OOS does not flash on the PI when the car is out of group
<b>Default</b>	
<b>Default Floors</b>	Default learned floor values
<b>Default Run Timers</b>	Default Run Timer values
<b>Default I/O</b>	Default inputs and outputs
<b>Default Factory</b>	Restore all parameters to factory settings
<b>Default Other</b>	Defaults all miscellaneous values

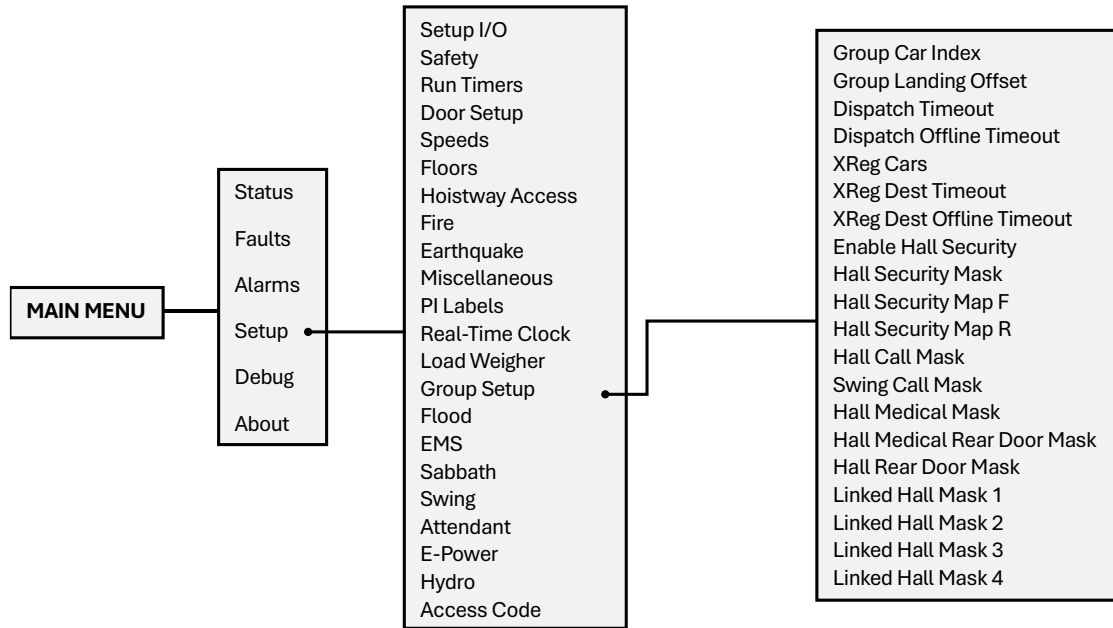

Figure 120: Setup – Group Setup Menus

The table below lists the Setup – Group Setup menu structures.

Table 54: Setup – Group Setup Menu Structures

Menu	Description
<b>Setup</b>	
<b>PI Labels</b>	Set Position Indicator labels
<b>Real-Time Clock</b>	Set internal clock time for fault identification
<b>Group Setup</b>	Group setup parameters
<b>Group Setup</b>	
<b>Group Car Index</b>	Sets the car's group ID.
<b>Group Landing Offset</b>	Sets an offset to the bottom landing so hall calls can be aligned properly for all cars in a group. If car 1 serves landing 1 and car 2 starts servicing landing 2, then car 2 would have an offset of 1.
<b>Dispatch Timeout (1 sec)</b>	Sets the time the car has to respond to a destination assignment before it temporarily removes itself from the group and the call is be reassigned. This prevents excessive delays in answering hall calls due to someone holding open the car door. If either the dispatch timeout or dispatch offline are set to zero, this feature is disabled. Should be set to 0 if only one car is in the group.
<b>Dispatch Offline (1 sec)</b>	Sets the time the car removes itself from the group after failing to take an assigned call. If either the dispatch timeout or dispatch offline are set to zero, this feature is disabled.
<b>XReg Cars</b>	Sets the number of X-Reg cars to include in dispatching
<b>XReg Dest Timeout (10 sec)</b>	Sets the time the XReg car has to respond to a destination assignment before it temporarily removes itself from the group and the call is be reassigned. This prevents excessive delays in answering hall calls due to someone holding open the car door. If either the dispatch timeout or dispatch offline are set to zero, this feature is disabled.

Menu	Description
<b>XReg Dest Offline Timeout (10 sec)</b>	Sets the time the XReg car removes itself from the group after failing to take an assigned call. If either the dispatch timeout or dispatch offline are set to zero, this feature is disabled.
<b>Enable Hall Security</b>	Enables Hall Security
<b>Hall Security Mask</b>	Turn ON/OFF which hall board function will have hall call security.
<b>Hall Security Map Front</b>	Turn ON/OFF Hall Call security for front landings
<b>Hall Security Map Rear</b>	Turn ON/OFF Hall Call security for rear landings
<b>Hall Call Mask</b>	Turn ON/OFF which hall board function the car will respond to for hall calls
<b>Swing Call Mask</b>	Turn ON/OFF which hall board functions the car will treat as a swing hall call. NOTE: Swing call mask cannot overlap with Medical Mask or Hall Call Mask.
<b>Hall Medical Mask</b>	Turn ON/OFF which hall board functions the car will treat as Emergency Medical Service call. NOTE: Medical Mask cannot overlap with Swing call mask or Hall Call Mask.
<b>Hall Medical Rear Door Mask</b>	Turn ON/OFF which hall board functions the car will treat as rear Emergency Medical Service call. NOTE: Medical Mask cannot overlap with Swing call mask or Hall Call Mask.
<b>Hall Rear Door Mask</b>	Turn ON/OFF which hall board functions are for rear opening. This acts as a modifier to the mask it overlaps with.
<b>Linked Hall Mask 1</b>	First set of Hall board functions that are turned ON are linked together. If 01 is ON and 02 is ON, a hall call on function 1 would latch the lamp for function 2.
<b>Linked Hall Mask 2</b>	Second set of Hall board functions that are turned ON are linked together. If 01 is ON and 02 is ON, a hall call on function 1 would latch the lamp for function 2.
<b>Linked Hall Mask 3</b>	Third set of Hall board functions that are turned ON are linked together. If 01 is ON and 02 is ON, a hall call on function 1 would latch the lamp for function 2.
<b>Linked Hall Mask 4</b>	Fourth set of Hall board functions that are turned ON are linked together. If 01 is ON and 02 is ON, a hall call on function 1 would latch the lamp for function 2.

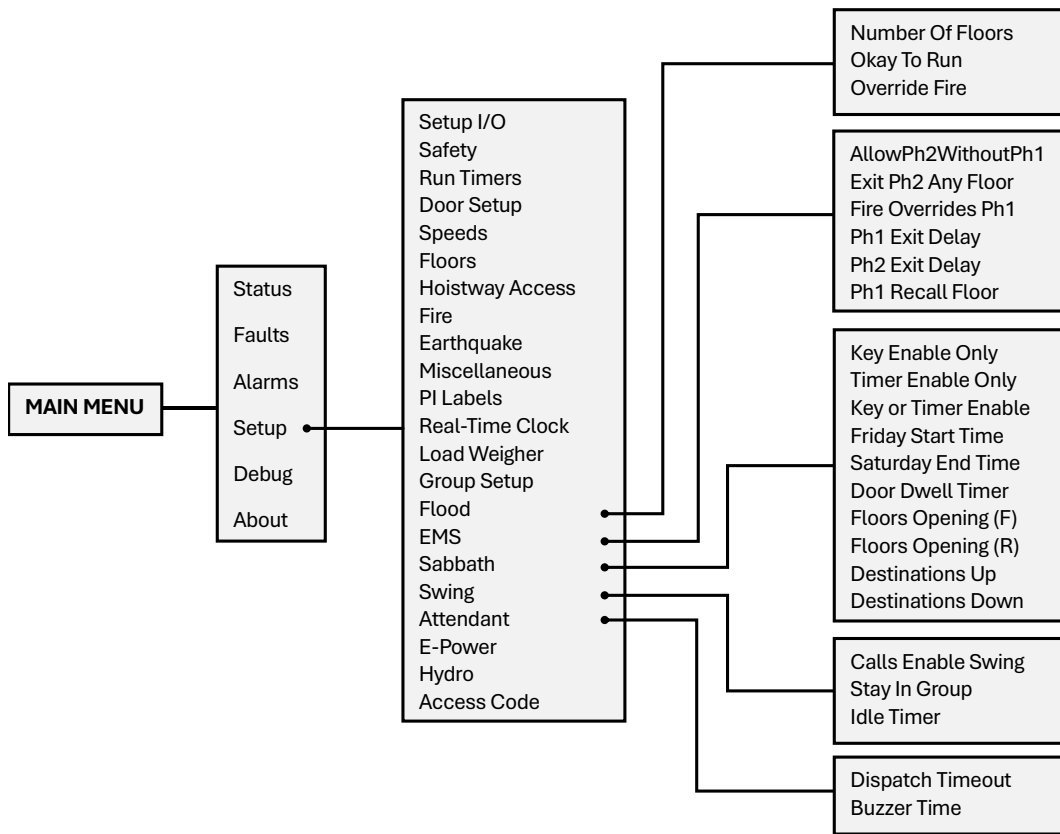

Figure 121: Setup – Flood, EMS, Sabbath, Swing, and Attendant Menus

The table below lists the Setup – Flood, EMS, Sabbath, Swing, and Attendant menu structures.

Table 55: Setup – Flood, EMS, Sabbath, Swing, and Attendant Menu Structures

Menu	Description
<b>Setup</b>	
<b>Flood</b>	Flood options
<b>EMS</b>	Emergency medical service options
<b>Sabbath</b>	Sabbath operation options
<b>Swing</b>	Swing operation options
<b>Attendant</b>	Attendant service options
<b>Flood</b>	
<b>Number of Floors</b>	Used in conjunction with the flood switch input. If a flood is detected, then this parameter tells the controller which floors to avoid. If set to zero, the elevator can go to all floors. If the flood switch is active and this parameter is set to one, then the car is not allowed to go to the bottom floor. If set to two, then elevator cannot go to bottom two floors, etc.
<b>Okay to Run</b>	Allows car to continue to run above the configured flood sensor floor
<b>Override Fire</b>	Allows flood operation to take priority over fire operation
<b>EMS</b>	
<b>Allow Ph2WithoutPh1</b>	Allows activation of Medical Phase 2 even if the car was never placed on Phase 1

Menu	Description
<b>Exit Ph2 Any Floor</b>	Allows exiting of EMS Phase 2 at any floor. Jobs with full hospital service should have this parameter turned ON. Jobs with EMT service should have this parameter OFF.
<b>Fire Overrides Ph1</b>	When set ON, the activation of a smoke or Fire Phase 1 key causes a car that is currently on EMS Phase 1 to exit medical service and go on Fire Phase 1 recall. When turned OFF, the car remains on EMS Phase 1.
<b>Ph1 Exit Delay (1 sec)</b>	When a car is called to a landing by an EMS Phase 1 key, this parameter specifies how long it will remain there before returning to normal operation if no one places it on EMS Phase 2.
<b>Ph2 Exit Delay (1 sec)</b>	Specifies how long to wait after exiting EMS Phase 2 before returning to normal operation. A programmable delay allows time for the patient to be removed from the elevator if EMS Phase 2 were turned off prior to removing the patient.
<b>Ph1 Recall Floor</b>	The floor at which the car recalls to during MA EMS mode.
<b>Sabbath</b>	
<b>Key Enable Only</b>	When set ON, Sabbath operations is only activated by keyswitch input
<b>Timer Enable Only</b>	When set ON, Sabbath operation is activated by only the configured Sabbath Start Time and Sabbath End Time
<b>Key or Timer Enable</b>	When set ON, Sabbath operation is activated by either keyswitch input or configured Sabbath Start Time and Sabbath End Time
<b>Friday Start Time</b>	Sets the Friday start time for Sabbath when timer enable is set. Format is HHMM, for example 12:34 PM would be 1234.
<b>Saturday End Time</b>	Sets the Saturday end time for Sabbath when timer enable is set. Format is HHMM, for example, 12:34 PM would be 1234.
<b>Door Dwell Timer (1 sec)</b>	Sets the time car doors remain open while in Sabbath operation
<b>Sabbath (F)</b>	Sets the front opening floors to be serviced during Sabbath operation
<b>Sabbath (R)</b>	Sets the rear opening floors to be serviced during Sabbath operation
<b>Destinations Up</b>	Set which floors to stop at during Sabbath up operation
<b>Destinations Down</b>	Set which floors to stop at during Sabbath down operation
<b>Swing</b>	
<b>Calls Enable Swing</b>	Allows swing calls to activate swing operation
<b>Stay in Group</b>	Allows the car to continue to take regular hall calls while in swing operation
<b>Idle Timer (1 sec)</b>	If Swing Mode is entered by a button press, this timer specifies how long to remain in Swing operation once the car is idle
<b>Attendant</b>	
<b>Dispatch Timeout</b>	Sets the time the car removes itself from answering hall calls after failing to take an assigned call while on attendant service. If either the dispatch timeout or dispatch offline are set to zero, this feature is disabled. If only one car is on attendant service, this feature should be disabled.
<b>Buzzer Time (100ms)</b>	Specifies how long to sound the buzzer to alert the attendant that a hall call was pressed

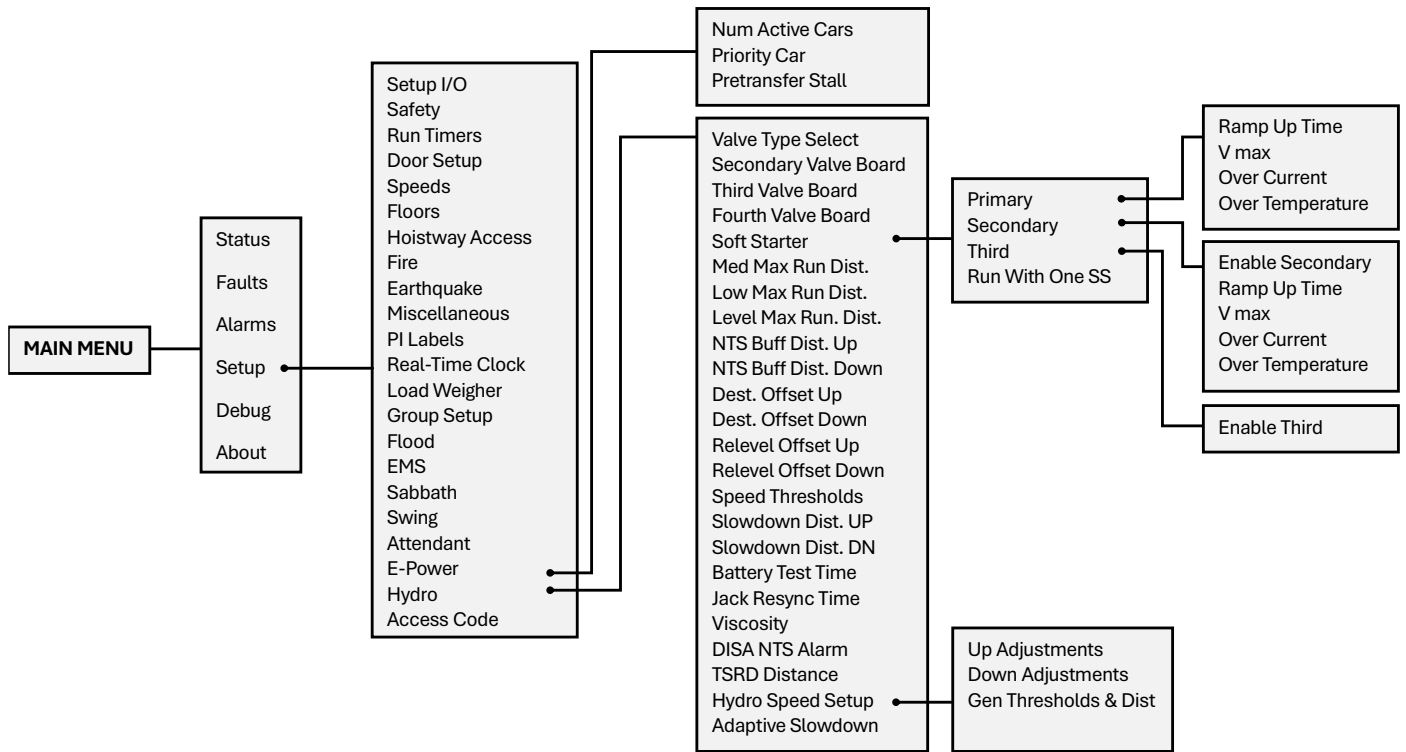

Figure 122: Setup – E-Power and Hydro Menus

The table below lists the Setup – E-Power and Hydro menu structures.

Table 56: Setup – E-Power and Hydro Menu Structures

Menu	Description
<b>Setup</b>	
<b>E-Power</b>	Emergency power options
<b>Hydro</b>	Hydro Operations
<b>E-Power</b>	
<b>Num of Active Cars</b>	Sets the number of cars allowed to run during emergency power operation
<b>Priority Car</b>	Sets the first car selected when on emergency power and when the auto select input is active.
<b>Pretransfer Stall</b>	When set ON, if the Emergency Power Pretransfer input is active, cars stop in a faulted state wherever they are. When set to OFF, cars instead move to the nearest landing and go out of service with the door open. This option is used when the system is wired to use pretransfer input to delay cars both at the transfer into and out of emergency power.
<b>Hydro</b>	
<b>Valve Type Select</b>	Allows the user to choose the type of valve used in the system
<b>Secondary Valve Board</b>	Checks for secondary Valve board when set to ON at startup
<b>Soft Starter</b>	Allows the user to select soft starter options
<b>Med Max Run Dist.</b>	Sets the maximum run distance when the medium valve speed run is selected. Longer runs will use the next higher speed valve. When set to zero, the valve is disabled.

Menu	Description
Low Max Run Dist.	Sets the maximum run distance when the low valve speed run is selected. Longer runs will use the next higher speed valve. When set to zero, the valve is disabled.
Level Max Run Dist.	Sets the maximum run distance when the level valve speed run is selected. Longer runs will use the next higher speed valve. When set to zero, the valve is disabled.
NTS Buffer Dist. Up	Distance added to the slowdown distance to cut off high valves in the up direction
NTS Buffer Dist. Down	Distance added to the slowdown distance to cut off high valves in the down direction
Dest. Offset Up	Distance from the destination position that the car cuts its leveling valve when moving in the up direction on a non-releveling run
Dest. Offset Down	Distance from the destination position that the car cuts its leveling valve when moving in the down direction on a non-releveling run
Relevel Offset Up	Distance from the destination position that the car cuts its leveling valve when moving in the up direction on a releveling run
Relevel Offset Down	Distance from the destination position that the car cuts its leveling valve when moving in the down direction on a releveling run
Speed Thresholds	Positioning system speed feedback is used for this comparison
Slowdown Dist. UP	Distance when the car starts slowing down on a normal run while moving in up direction
Slowdown Dist. DN	Distance when the car starts slowing down on a normal run while moving in down direction
Battery Test Time	Sets the time to check the battery board
Jack Resync Time	Sets the time to trigger Jack Resync
Viscosity	Sets the run time and rest time for viscosity
DISA NTS Alarm	Disables NTS alarms
TSRD Distance	Sets the distance to prevent car from hitting the buffer
<b>Soft Starter</b>	
Primary	Enables primary soft starter
Secondary	Enables secondary soft starter
Third	Enables third soft starter
Run With One SS	When set to ON, if two soft starters are supported, and only one of those soft starters is faulted, the car will still be allowed to run.
<b>Primary</b>	
Ramp Up Time	Sets the primary soft starter time to ramp up to V-Max
Vmax	Sets the primary soft starter percentage of input AC voltage used for ramp up
Over Current	Sets the primary soft starter overcurrent limit in amps
Over Temperature	Sets the primary soft starter over temperature limit in degrees Fahrenheit counts
<b>Secondary</b>	
Enable Secondary	Enables secondary soft starter
Ramp Up Time	Sets the secondary soft starter time to ramp up to V-Max
Vmax	Sets the secondary soft starter percentage of input AC voltage used for ramp up
Over Current	Sets the secondary soft starter overcurrent limit in amps
Over Temperature	Sets the secondary soft starter over temperature limit in degrees Fahrenheit counts

Menu	Description
<b>Third</b>	
<b>Enable Third</b>	Enables third soft starter
<b>Hydro Speed Setup</b>	
<b>Up Adjustments</b>	Adjust speed when transitioning from contract speed to leveling speed in the up direction
<b>Down Adjustment</b>	Adjust speed when transitioning from contract speed to leveling speed in the down direction
<b>Generate Thresholds and Distance</b>	Updates threshold and slowdown distances based on adjustment settings

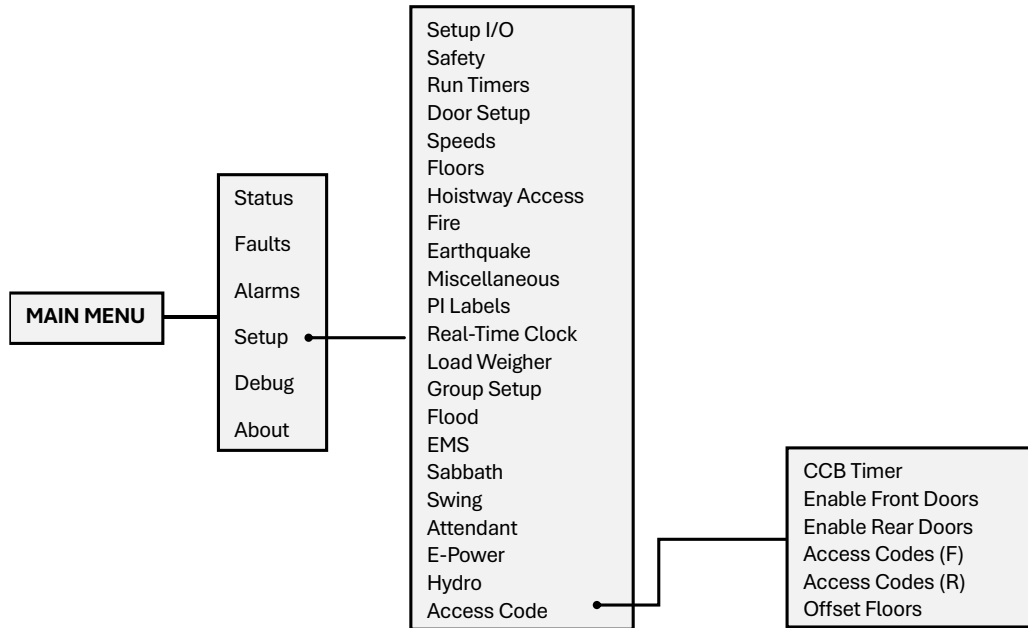

Figure 123: Setup – Access Code Menu

The table below lists the Setup – Access Code menu structures.

Table 57: Setup – Access Code Menu Structures

Menu	Description
<b>Setup</b>	
<b>Access Code</b>	Access code options
<b>Access Code</b>	
<b>CCB Timer</b>	Time for registering a car call after access code is entered
<b>Enable Front Doors</b>	Disables access code on front doors
<b>Enable Rear Doors</b>	Disables access code on rear doors
<b>Access Code (F)</b>	Code that gives access to front door car calls
<b>Access Code (R)</b>	Code that gives access to rear door car calls
<b>Offset Floors</b>	The first floors to offset when applying the access code

### 1.4 Debug

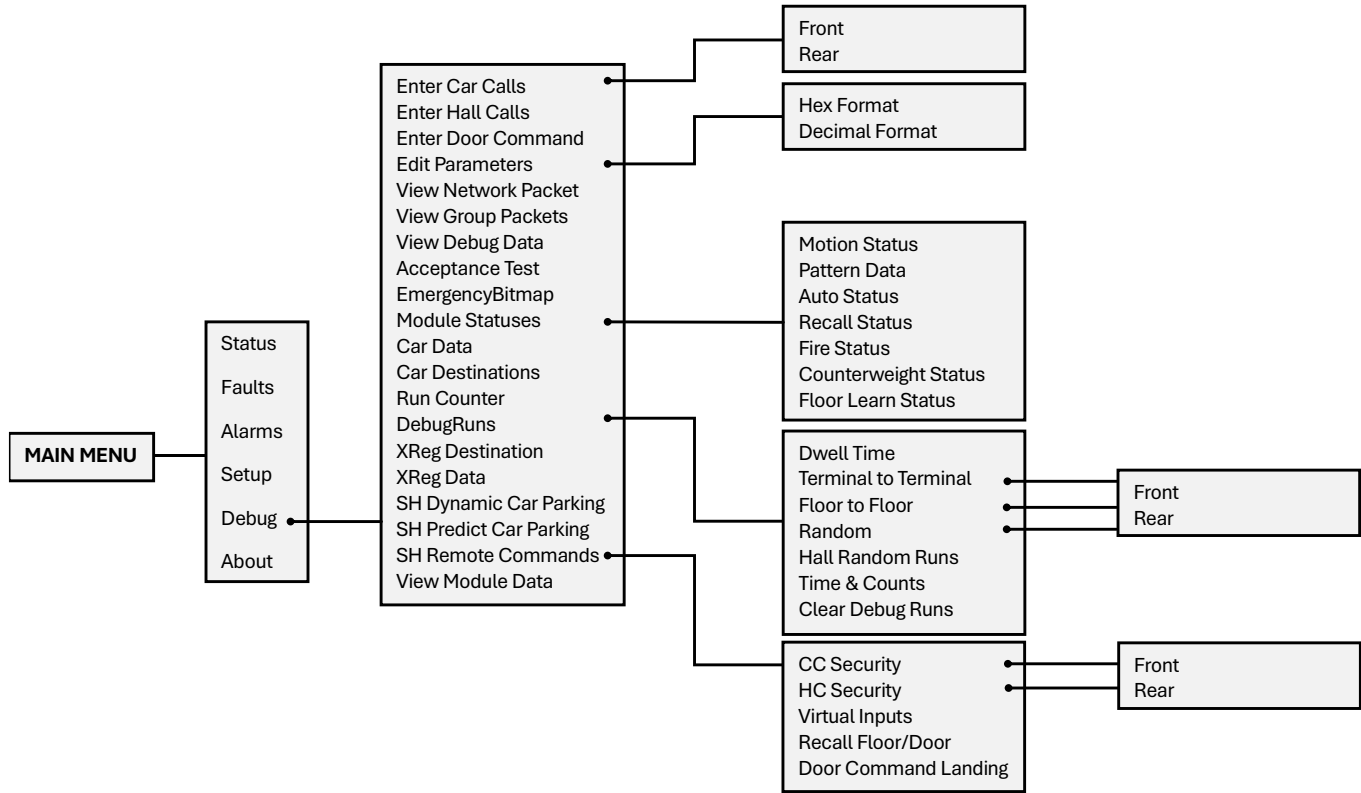

Figure 124: Debug Menus

The table below lists the Debug menu structures.

Table 58: Debug Menu Structures

Menu	Description
<b>MAIN MENU</b>	
<b>Debug</b>	Debug menu options
<b>About</b>	View job name and software version
<b>Debug</b>	
<b>Enter Car Calls</b>	Manually latch car calls. Calls entered here bypass security.
<b>Enter Hall Calls</b>	Enter hall calls to a specific landing and mask
<b>Enter Door Command</b>	Enter door commands
<b>Edit Parameters</b>	Edit parameters in hex or decimal
<b>View Network Packet</b>	Debug option to view network packets
<b>View Group packets</b>	Debug option to view group packets
<b>View Debug Data</b>	Debug option to view various controller data
<b>Acceptance Test</b>	Acceptance testing options
<b>EmergencyBitmap</b>	Emergency power debug option
<b>Module Statuses</b>	Debug option to view module status
<b>Car Data</b>	View car data
<b>Car Destination</b>	View car destination data
<b>Run Counter</b>	View number of runs car completed
<b>DebugRuns</b>	Random run generator
<b>XReg Destination</b>	Cross registration destination data

Menu	Description
<b>XReg Data</b>	Miscellaneous cross registration data
<b>SH Dynamic Parking</b>	Parking based on priority landings
<b>SH Predict Parking</b>	Parking assignment based on prior history
<b>SH Remote Commands</b>	Virtual commands to the controller
<b>View Module Data</b>	View various information associated to specific modules
<b>Enter Car Calls</b>	
<b>Front</b>	Generate front car calls
<b>Rear</b>	Generate rear car calls
<b>Edit Parameters</b>	
<b>Hex Format</b>	Edit parameters in Hex format
<b>Decimal Format</b>	Edit parameters in Decimal format
<b>Module Statuses</b>	
<b>Motion Status</b>	Motion sequence status
<b>Pattern Data</b>	View status of pattern
<b>Auto Status</b>	View status of auto operation
<b>Recall Status</b>	View status of car recall operation
<b>Fire Status</b>	View status of fire service operation
<b>Counterweight Status</b>	View status of counterweight derailment
<b>Floor Learn Status</b>	View status of floor learn operation
<b>DebugRuns</b>	
<b>Dwell Time</b>	Time between debug car calls for random call generator
<b>Terminal to Terminal</b>	Enables terminal to terminal runs
<b>Floor to Floor</b>	Enables floor to floor calls
<b>Random</b>	Generates random car calls
<b>Hall Random Runs</b>	Generates random hall calls
<b>Time &amp; Counts</b>	Displays the elapsed time and number of trips when the car is on floor-to-floor, terminal-to-terminal, and random runs modes.
<b>Clear Debug Runs</b>	Clears any/all debug runs
<b>Terminal to Terminal</b>	
<b>Front</b>	Enables front door terminal to terminal runs
<b>Rear</b>	Enables rear door terminal to terminal runs
<b>Random</b>	
<b>Front</b>	Enables front door random calls
<b>Rear</b>	Enables rear door random calls
<b>SH Remote Commands</b>	
<b>CC Security</b>	Allows for remote secure car calls
<b>HH Security</b>	Allows for remote secure hall call
<b>Virtual Inputs</b>	Allows for a variety of inputs set remotely
<b>Recall/Floor Door</b>	Sets recall floor and door that opens when remote recall to floor input is asserted
<b>Door Command Landing</b>	Sets door command to a designated landing
<b>CC Security</b>	
<b>Front</b>	Enables front door security car calls
<b>Rear</b>	Enables rear door security car calls
<b>HC Security</b>	
<b>Front</b>	Enables front door security hall calls
<b>Rear</b>	Enables rear door security hall calls

## 2 High-Level Navigation Menu Structure

The high-level navigation presents a hierarchical structure of menus used for setup, troubleshooting, and status checks of the controller.

### 2.1 Main Menu

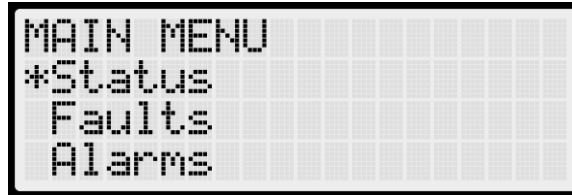

Figure 125: MAIN MENU – Status, Faults, Alarms



Figure 126: MAIN MENU – Setup, Debug, About

### 2.2 Status

The STATUS menus provide real-time information about key system functions.

#### 2.2.1 Inputs, Outputs, Valve Statuses

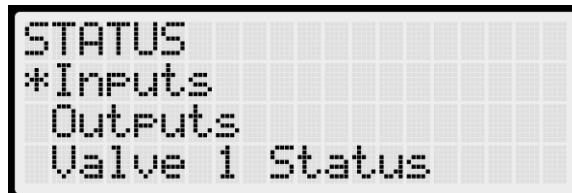

Figure 127: STATUS Menu – Inputs, Outputs, Valve 1 Status



Figure 128: STATUS Menu – Valve 2 Status, Valve 3 Status, Valve 4 Status

```

INPUTS BY FUNCTION
*Inspection
  Locks (F)
  Locks (R)
    
```

Figure 129: INPUTS BY FUNCTION Menu – Inspection

```

INSPECTION
[X] MR Inspection
[ ] MR UP
[ ] MR DN
    
```

Figure 130: INPUTS BY FUNCTION – INSPECTION Menu Example

```

OUTPUTS BY FUNCTION
  Inspect/Access
*Controller
  Safety
    
```

Figure 131: OUPTUS BY FUNCTION Menu – Controller

```

CONTROLLER
[ ] Light Fan
[ ] Battery Pwr
[ ] Safety Rescue
    
```

Figure 132: OUPTUS BY FUNCTION – CONTROLLER Menu Example

```

OFFLINE
ERROR: UNK
VERSION: 0
[ ][ ][ ] SM
    
```

Figure 133: Valve Status Menu – Part 1 of 3

```

[ ][ ][ ] SAFE & NTS
[ ][ ][ ] UH
[ ][ ][ ] UL
[ ][ ][ ] DH
    
```

Figure 134: Valve Status Menu – Part 2 of 3



Figure 135: Valve Status Menu – Part 3 of 3

Refer to the **System Configurations** for further details on the Valve Status menu.

### 2.2.2 Soft Starter Statuses, Expansion Status

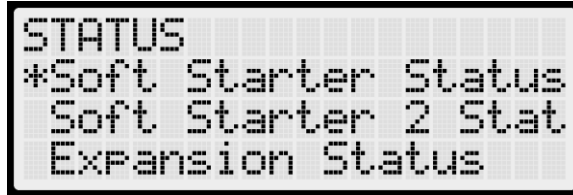

Figure 136: STATUS Menu – Soft Starter Status, Soft Starter 2 Status, Expansion Status



Figure 137: Soft Starter Status Menu – Part 1 of 3

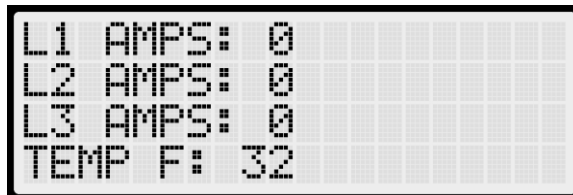

Figure 138: Soft Starter Status Menu – Part 2 of 3

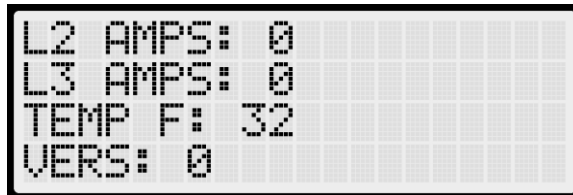

Figure 139: Soft Starter Status Menu – Part 3 of 3

Refer to the **System Configurations** for further details on the Soft Starter Status menu.

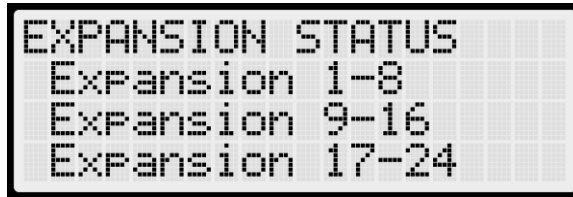

Figure 140: EXPANSION STATUS Menu – Expansion Group

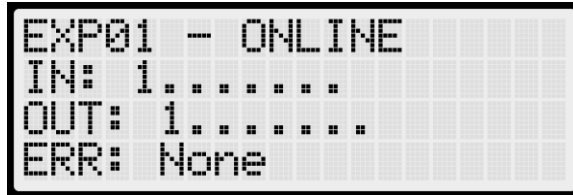

Figure 141: Active Expansion Board Status

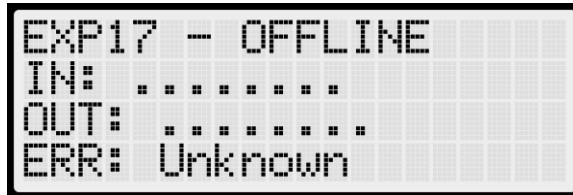

Figure 142: Inactive Expansion Board Status

Refer to the **System Configurations** for further details on the Expansion Status menu.

### 2.2.3 Riser Board Status, Hall Board Status, Hall Lantern Status

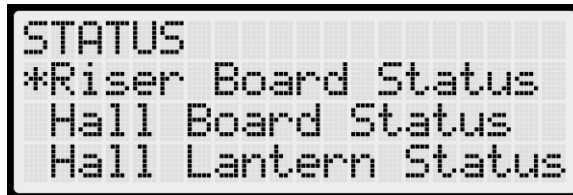

Figure 143: STATUS Menu – Riser Board Status, Hall Board Status, Hall Lantern Status

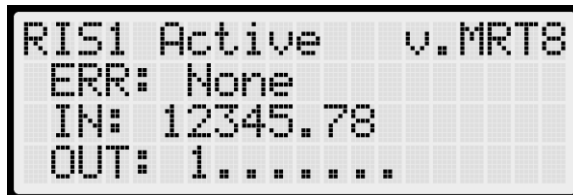

Figure 144: Active Riser Board Status

```
RIS1 InActive v.MRT8
ERR: Unknown
IN: .....
OUT: .....
```

Figure 145: Inactive Riser Board Status

Refer to the **System Configurations** for further details on the Riser Board Status menu.

```
LND01 - F1 - RIS1
COM:100% ERR:NONE
0001 SW: 123456.....
*      UL DL UB DB
```

Figure 146: Hall Board Status

```
LND01 - F1 - N/A
COM:N/A% ERR:UNK
0001 SW: .....
*      .. .. .. ..
```

Figure 147: Uninitialized Hall Board Status

Refer to the **System Configurations** for further details on the Hall Board Status menu.

```
LND01 - F1
COM:N/A ERR:NONE
0001 SW: .....
*      .. .. .. ..
```

Figure 148: Hall Lantern Status

```
LND01 - F1 - N/A
COM:N/A ERR:NONE
001   SW: .....
*      .. .. .. ..
```

Figure 149: Uninitialized Hall Lantern Status

2.2.4 Hall Security Status, Hall Call Status, DAD Status

```

STATUS
*Hall Security Statu
Hall Call Status
DAD Status
    
```

Figure 150: STATUS Menu – Hall Security Status, Hall Call Status, DAD Status

```

LND01 - F1 - RIS1
COM:100% ERR:NONE
0001 SW: 123456.....
*          UL DL UB DB
    
```

Figure 151: Hall Security Status

```

HALL CALL STATUS
Up Calls
Down Calls
    
```

Figure 152: HALL CALL STATUS Menu – Up or Down Calls

```

UP CALLS - CAR8
01F 01R
    
```

Figure 153:UP CALLS Menu

```

DOWN CALLS - CAR2
05F 05R
    
```

Figure 154: DOWN CALLS Menu

```

DAD STATUS - ONLINE
ERROR:  NONE
Version: 1.22
RX Count:00050
    
```

Figure 155: DAD STATUS Menu

Refer to the **Features & Modes of Operation** for further details on the DAD Status menu.

**2.2.5 Clock, CPLD Status, Load Weigher Status**



Figure 156: STATUS Menu – Clock, CPLD Status, Load Weigher Status



Figure 157: Real-Time Clock Menu

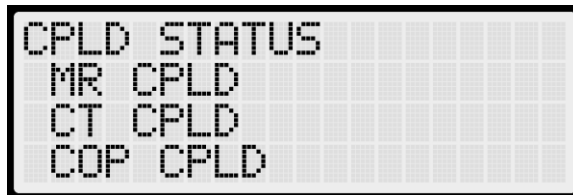

Figure 158: CPLD STATUS Menu – MR, CT, COP CPLD

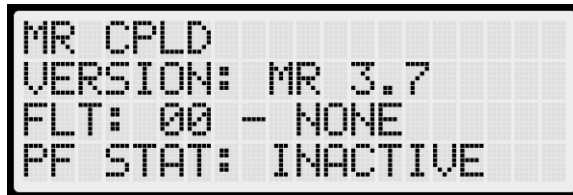

Figure 159: MR CPLD Menu

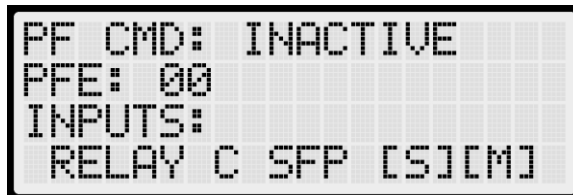

Figure 160: MR CPLD Menu Continued

```

CT CPLD
VERSION: CT 3.7
FLT: 00 - NONE
PF STAT: INACTIVE
    
```

Figure 161: CT CPLD Menu

```

PM CMD:  INACTIVE
PFE: 00
INPUTS:
CT SW      [S][M]
    
```

Figure 162: CT CPLD Menu Continued

```

COP CPLD
VERSION: COP 3.7
FLT: 00 - NONE
PF STAT: INACTIVE
    
```

Figure 163: COP CPLD Menu

```

PF CMD:  INACTIVE
PFE: 00
INPUTS:
HA INSP   [ ][ ]
    
```

Figure 164: COP CPLD Menu Continued

Refer to the **System Configurations** for further details on the CPLD Status menu.

### 2.2.6 E-Power Status, EMS Status, Virtual Inputs

```

STATUS
*E-Power Status
EMS Status
Virtual Inputs
    
```

Figure 165: STATUS Menu – E-Power Status, EMS Status, Virtual Inputs

```
E-POWER COMMAND
CAR1: AUTO
CAR2: RECALL
CAR3: 005
```

Figure 166: E-POWER COMMAND Menu

```
E-POWER COMMAND
CAR7: OFF
CAR8: OFF
MODE: ON
```

Figure 167: E-POWER COMMAND Menu Continued

Refer to the **System Configurations** for further details on the E-Power Status menu.

```
EMS ASSIGNMENT
CAR1: LND 08
CAR2: NONE
CAR3: NONE
```

Figure 168: EMS STATUS Menu – Car 1 Assigned

```
EMS ASSIGNMENT
CAR1: NONE
CAR2: NONE
CAR3: NONE
```

Figure 169: EMS STATUS Menu – No Cars Assigned

```
REMOTE COMMANDS
*Car Call Security
Hall Call Security
Virtual Inputs
```

Figure 170: REMOTE COMMANDS Menu – Car Call Security, Hall Call Security, Virtual Inputs

```
SECURE CAR CALLS
Front
Rear
```

Figure 171: SECURE CAR CALLS Menu – Front or Rear

```
Secure Car Front
FLR 1-32 :00000009
FLR 33-65:00000000
FLR 66-96:00000000
```

Figure 172: Secure Car Front Menu

```
Secure Car Rear
FLR 1-32 :00000000
FLR 33-64:00000000
FLR 65-96:00000000
```

Figure 173: Secure Car Rear Menu

```
SECURE HALL CALLS
Front
Rear
```

Figure 174: SECURE HALL CALLS Menu – Front or Rear

```
Secure Front HC
FLR 1-32 :00000011
FLR 33-64:00000000
FLR 65-96:00000000
```

Figure 175: Secure Front Hall Call Menu

```
Secure Rear HC
FLR 1-32 :00000001
FLR 33-65:00000010
FLR 66-96:00000000
```

Figure 176: Secure Rear Hall Call Menu

```
Virtual Input
[ ] Latch New CC
[ ] E-Power Manual
[ ] E-Power Select 1
```

Figure 177: Virtual Input Menu

```
REMOTE COMMANDS
Virtual Inputs
*Recall Input
Door Command Landin
```

Figure 178: REMOTE COMMANDS Menu – Recall Input, Door Command Landing

```
Recall Floor/Door
Floor:00
Door :00
```

Figure 179: Recall Floor/Door Menu

```
Door Command Landing
Floor:000
```

Figure 180: Door Command Landing Menu

### 2.2.7 DIP Status, Door Status

```
STATUS
*DIP Status
Door Status (F)
Door Status (R)
```

Figure 181: STATUS Menu – DIP Status, Door Status (F), Door Status (R)

```
DIP STATUS
MR DIP
CT DIP
COP DIP
```

Figure 182: DIP STATUS Menu – MR, CT, or COP DIP

```
DIPS MR      12345678
BANKA:.....X
BANKB:.....
```

Figure 183: DIP SWITCHES Menu

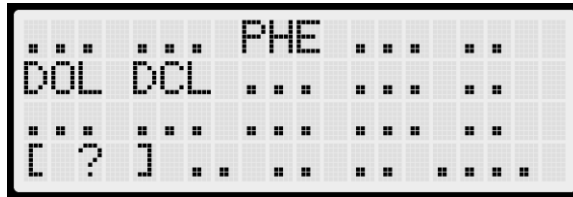

Figure 184: Door Status Menu

### 2.3 Faults

The FAULTS menu displays a list of active and logged faults.



Figure 185: FAULTS Menu – Active, Logged, Clear Log



Figure 186: Active Faults Menu

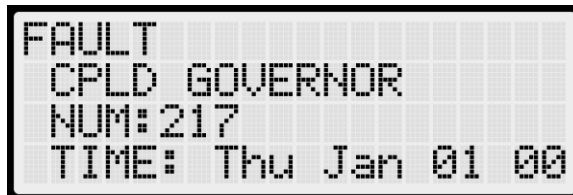

Figure 187: Fault Part 1 of 3



Figure 188: Fault Part 2 of 3

```
CMD: 0
ENC: 0
FLR: LL
DEST:LL
```

Figure 189: Fault Part 3 of 3

```
FAULT LOG
*1.CPLD Governor
 2.120VAC Loss
 3.SS SFM
```

Figure 190: FAULT LOG Menu

## 2.4 Alarms

The ALARMS menu displays a list of active and logged alarms.

```
ALARMS
*Active
  Logged
  Clear Log
```

Figure 191: ALARMS Menu – Active, Logged, Clear Log

```
ACTIVE ALARMS (7)
CPLD: No Alarm
MRA: Flood Switch
MRB: No Alarm
```

Figure 192: Active Alarms Menu

```
ALARM
Flood Switch
Num:129
Time: Thu Jan 01 00
```

Figure 193: Alarm Part 1 of 2

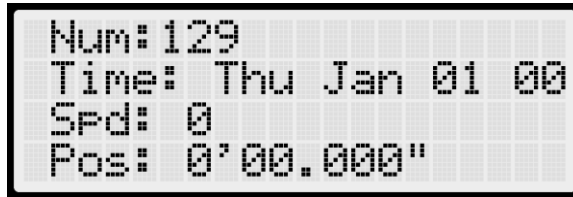

Figure 194: Alarm Part 2 of 2



Figure 195: ALARM LOG Menu

## 2.5 Setup

The SETUP menu contains options used for system configuration.

### 2.5.1 Setup I/O, Safety, Run Timers



Figure 196: SETUP MENU – Setup I/O, Safety, Run Timers

#### 2.5.1.1 Setup I/O – Invert Inputs, Invert Outputs, Setup Inputs

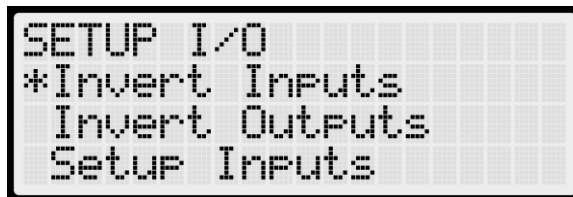

Figure 197: SETUP I/O Menu – Invert Inputs, Invert Outputs, Setup Inputs

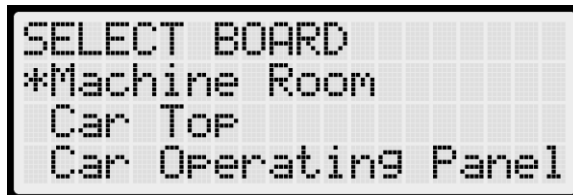

Figure 198: SELECT BOARD Menu – Machine Room, Car Top, Car Operating Panel



Figure 199: Invert Inputs Menu – Machine Room Example

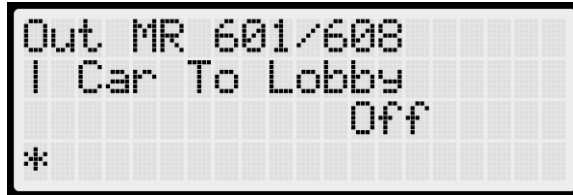

Figure 200: Invert Outputs Menu – Machine Room Example



Figure 201: Unused Input

### 2.5.1.2 Setup I/O – Setup Outputs

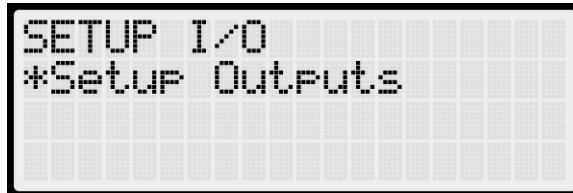

Figure 202: SETUP I/O Menu – Setup Outputs

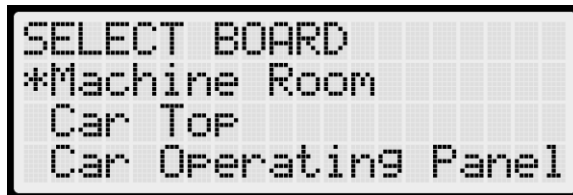

Figure 203: SELECT BOARD Menu – Machine Room, Car Top, Car Operating Panel

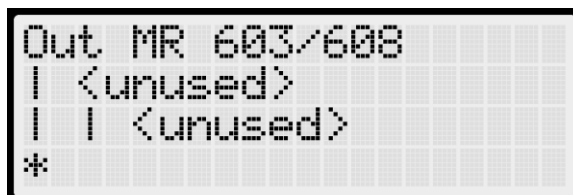

Figure 204: Unused Output

Refer to the **Inputs & Outputs** for further details on the Setup Inputs & Setup Outputs menus.

2.5.1.3 Safety – Speed Deviation, Lock Clip, General ODL



Figure 205: SAFETY Menu – Speed Deviation, Lock Clip, General ODL

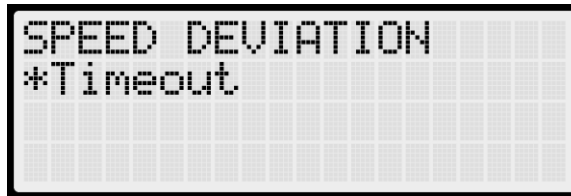

Figure 206: SPEED DEVIATION Menu – Timeout

2.5.1.4 Safety – NTS ODL, TSRD ODL



Figure 207: SAFETY Menu – NTS ODL, TSRD ODL

2.5.1.5 Run Timers – Start Timers, Stop Timers

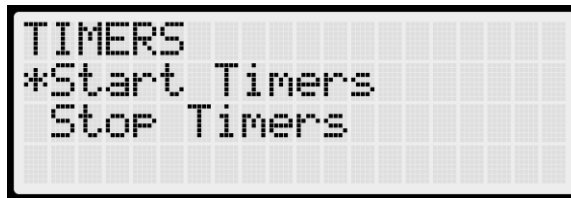

Figure 208: TIMERS Menu – Start Timers, Stop Timers

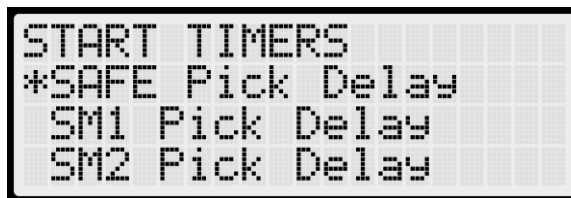

Figure 209: START TIMERS Menu – SAFE Pick Delay, SM1 Pick Delay, SM2 Pick Delay

```

START TIMERS
*Delta Pick Delay
    
```

Figure 210: START TIMERS Menu – Delta Pick Delay

```

STOP TIMERS
*Pump Off Delay
SAFE Drop Delay
    
```

Figure 211: STOP TIMERS Menu – Pump Off Delay. SAFE Drop Delay

## 2.5.2 Door Setup, Speeds, Floors

```

SETUP
*Door Setup
  Speeds
  Floors
    
```

Figure 212: SETUP MENU – Door Setup, Speeds, Floors

### 2.5.2.1 Door Setup – Control Doors, Door Dwell Timer, Hall Dwell Timer

```

DOORS
*Control Doors
  Door Dwell Timer
  Hall Dwell Timer
    
```

Figure 213: DOORS Menu – Control Doors, Door Dwell Timer, Hall Dwell Timer

```

F [ I ] DOOR [ I ] R
  CLOSE OPEN  NUDGE
  F  R  F  R  F  R
  *
    
```

Figure 214: CONTROL DOORS Menu

2.5.2.2 Door Setup – ADA Dwell Timer, Hold Dwell Timer, Lobby Dwell Timer

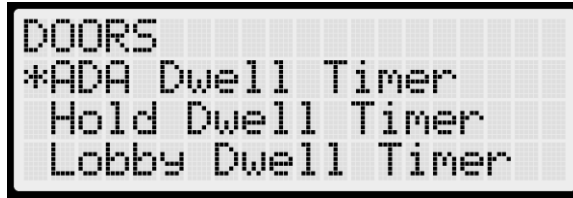

Figure 215: DOORS Menu – ADA Dwell Timer, Hold Dwell Timer, Lobby Dwell Timer

2.5.2.3 Door Setup – Door Stuck Timer, Door Nudge Timer, Rear Doors

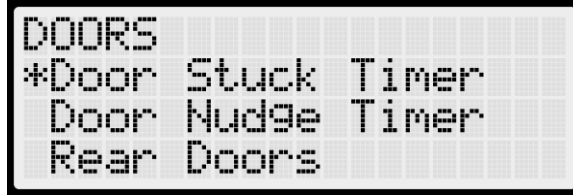

Figure 216: DOORS Menu – Door Stuck Timer, Door Nudge Timer, Rear Doors

2.5.2.4 Door Setup – PreOpening Distance, DC On Run, DC On Close

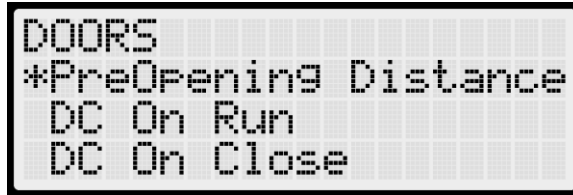

Figure 217: DOORS Menu – PreOpening Distance, DC On Run, DC On Close

2.5.2.5 Door Setup – DO On Open, Disable ON CT Stop, Disable On HA



Figure 218: DOORS Menu – DO On Open, Disable ON CT Stop, Disable On HA

2.5.2.6 Door Setup – AT400, No Demand DO, Jumper Timer



Figure 219: DOORS Menu – AT400, No Demand DO, Jumper Timer

2.5.2.7 Door Setup – Jumper On DOL, Hourly Fault Limit, Nudge – Buzzer Only

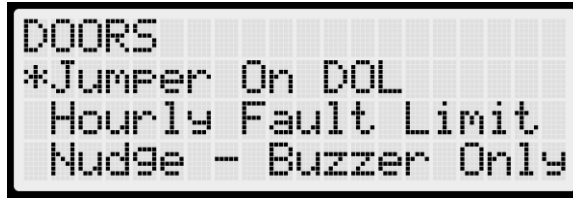

Figure 220: DOORS Menu – Jumper On DOL, Hourly Fault Limit, Nudge – Buzzer Only

2.5.2.8 Door Setup – Opening Time, Check Time



Figure 221: DOORS Menu – Opening Time, Check Time

2.5.2.9 Door Setup – Door Type, Swing Openings

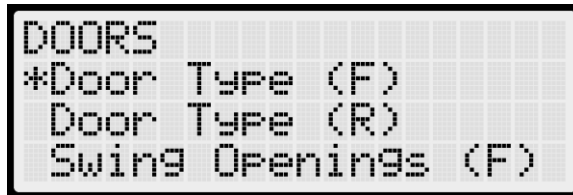

Figure 222: DOORS Menu – Door Type, Swing Openings



Figure 223: DOOR TYPE Menu



Figure 224: SWING DOOR OPENINGS Menu

2.5.2.10 Door Setup – Lock And CAM Timeout, Retiring CAM, Fixed CAM



Figure 225: DOORS Menu – Lock and CAM Timeout, Retiring CAM, Fixed CAM

2.5.2.11 Door Setup – Swing LCK GSW Timeout, Swing Contacts Timeout, Disable DOB Rear



Figure 226: DOORS Menu – Swing LCK GSW Timeout, Swing Contacts Timeout, Disable DOB Rear

2.5.2.12 Speeds – Contract Speed, Inspection Speed, Leveling Speed, Test Buffer Speed



Figure 227: SPEEDS Menu – Contract Speed, Inspection Speed, Leveling Speed



Figure 228: SPEEDS Menu – Test Buffer Speed

2.5.2.13 Floors – Number of Floors, Too High/ Too Low, Enable Releveling



Figure 229: FLOORS Menu – Number Of Floors, Too High/ Too Low, Enable Releveling

```

ADJUST FLOORS [  1]
[  1] -001.791" Save
01 = -00000091  |
                *
    
```

Figure 230: ADJUST FLOORS Menu – Too High

```

ADJUST FLOORS [  1]
[  1] +001.791" Save
01 = +00000091  |
                *
    
```

Figure 231: ADJUST FLOORS Menu – Too Low

2.5.2.14 Floors – Relevel Zone Size, Releveling Delay, Openings

```

FLOORS
*Relevel Zone Size
  Releveling Delay
  Openings (F)
    
```

Figure 232: FLOORS Menu – Relevel Zone Size, Releveling Delay, Openings

```

FLOOR OPENINGS (LL)
PIC1]
01 = On
                *
    
```

Figure 233: FLOOR OPENING Menu

2.5.2.15 Floors – Security, Wander Guard

```

FLOORS
*Security (F)
  Security (R)
  Wander Guard
    
```

Figure 234: FLOORS Menu – Security, Wander Guard

```
SECURITY FLOORS (F)
PI [ 1 ]
  01 = On
*
```

Figure 235: SECURITY FLOORS Menu

```
WANDER GUARD
PI [ 1 ]
  01 = Off
*
```

Figure 236: WANDER GUARD Menu

2.5.2.16 Floors – Store Floor Level, Short Floor Opening, Timed CC Security

```
FLOORS
*Store Floor Level
  Short Floor Opening
  Timed CC Security
```

Figure 237: FLOORS Menu – Store Floor Level, Short Floor Opening, Timed CC Security

```
FLOOR 01 [ LL ] Save
*
CURR: 0000' 00.000"
SAVE: 0000' 00.000"
```

Figure 238: STORE FLOORS Menu

```
SHORT FLOOR OPEN [ 4 ]
PI [ 1 ]
  06 = On
*
```

Figure 239: SHORT FLOOR OPENING Menu

```
TIMED CC SECURITY
*Enable Floor (F)
  Enable Floor (R)
  Start (M-F)
```

Figure 240: TIMED CC SECURITY Menu – Enable Floor, Start (M-F)

```
TIMED CC SECURITY
*Stop (M-F)
  Start (S-S)
  Stop (S-S)
```

Figure 241: TIMED CC SECURITY Menu – Stop (M-F), Start (S-S), Stop (S-S)

```
TIMED CC SEC (F)
PI [ B]
  01 = Off
  *
```

Figure 242: TIMED CC SEC Menu – Enable Floor (F) Example

### 2.5.2.17 Floors – Timed HC Security

```
FLOORS
*Timed HC Security
```

Figure 243: FLOORS Menu – Timed HC Security

```
TIMED HC SECURITY
*Enable Floor (F)
  Enable Floor (R)
  Start (M-F)
```

Figure 244: TIMED HC SECURITY Menu – Enable Floor, Start (M-F)

```
TIMED HC SECURITY
*Stop (M-F)
  Start (S-S)
  Stop (S-S)
```

Figure 245: TIMED HC SECURITY Menu – Stop (M-F), Start (S-S), Stop (S-S)

```
TIMED HC SEC (F)
PI [ B]
  01 = Off
  *
```

Figure 246: TIMED HC SEC Menu – Enable Floor (F) Example

2.5.3 Hoistway Access, Fire, Earthquake



Figure 247: SETUP MENU – Hoistway Access, Fire, Earthquake

2.5.3.1 Hoistway Access – Allowed Dist. Top, Allowed Dist. Bottom, Top Floor



Figure 248: HOISTWAY ACCESS – Allowed Distance Top, Allowed Dist. Bottom, Top Floor

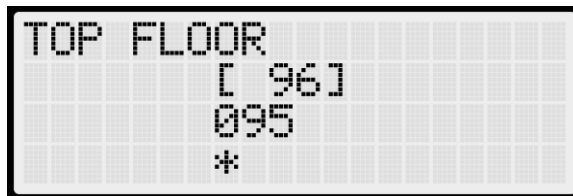

Figure 249: TOP FLOOR Menu

2.5.3.2 Hoistway Access – Bottom Floor, Top Opening, Bottom Opening

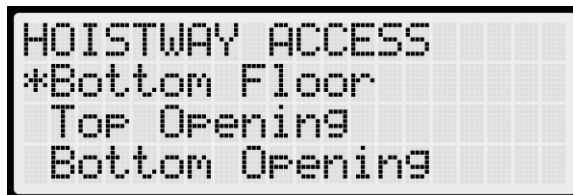

Figure 250: HOISTWAY ACCESS – Bottom Floor, Top Opening, Bottom Opening

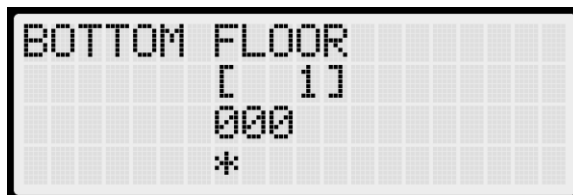

Figure 251: BOTTOM FLOOR Menu

2.5.3.3 Hoistway Access – HA Slide Distance

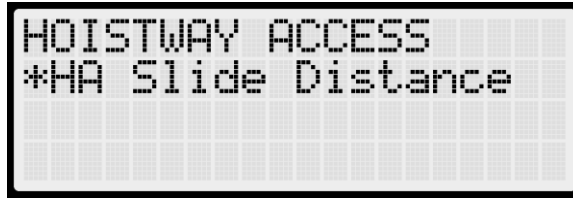

Figure 252: HOISTWAY ACCESS – HA Slide Distance

2.5.3.4 Fire – Main Recall, Alt Recall, Main Smoke Actions



Figure 253: FIRE SERVICE Menu – Main Recall, Alt Recall, Main Smoke Actions



Figure 254: MAIN RECALL Menu – Floor, Opening

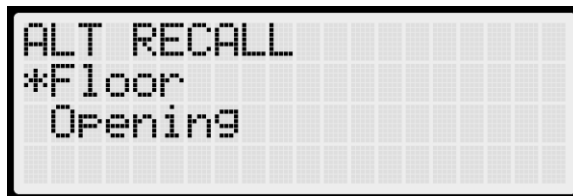

Figure 255: ALT RECALL Menu – Floor, Opening



Figure 256: MAIN SMOKE ACTION Menu – Main or Alt, Flash Fire Hat, Shunt Trip

2.5.3.5 Fire – Alt Smoke Actions, Hoistway Smoke Actions, MR Smoke Actions



Figure 257: FIRE SERVICE Menu – Alt Smoke Actions, Hoistway Smoke Actions, MR Smoke Actions



Figure 258: ALT SMOKE ACTION Menu – Main or Alt, Flash Fire Hat, Shunt Trip



Figure 259: HOISTWAY SMOKE ACTION Menu – Main or Alt, Flash Fire Hat, Shunt Trip



Figure 260: MR SMOKE ACTION Menu – Main or Alt, Flash Fire Hat, Shunt Trip

2.5.3.6 Fire – Recall Key, PIT Smoke, Alt Machine Room, Advance Configs



Figure 261: FIRE SERVICE Menu – Recall Key, PIT Smoke, Alt Machine Room



Figure 262: FIRE SERVICE Menu – Advance Configs

```

RECALL KEY
*Flash Fire Hat
    
```

Figure 263: RECALL KEY Menu – Flash Fire Hat

```

PIT SMOKE
*Main or Alt
Flash Fire Hat
Shunt Trip
    
```

Figure 264: PIT SMOKE Menu – Main or Alt, Flash Fire Hat, Shunt Trip

```

ALT MACHINE ROOM
*Enable Alt. MR
HW 2 Smoke
MR 2 Smoke
    
```

Figure 265: ALT MACHINE ROOM Menu – Enable Alt. MR, HW 2 Smoke, MR 2 Smoke

```

HOISTWAY 2 SMOKE
*Main or Alt
Flash Fire Hat
Shunt Trip
    
```

Figure 266: HOISTWAY 2 SMOKE Menu – Main or Alt, Flash Fire Hat, Shunt Trip

```

MR 2 SMOKE
*Main or Alt
Flash Fire Hat
Shunt Trip
    
```

Figure 267: MR 2 SMOKE Menu – Main or Alt

```

SMOKE CONFIGURATION
PHASE 2 SWING REOPEN
3 = OFF
*
    
```

Figure 268: SMOKE CONFIGURATION Menu

2.5.3.7 Earthquake – Enable EQ, Set CW Pos



Figure 269: EARTHQUAKE Menu – Enable EQ, Set CW Pos

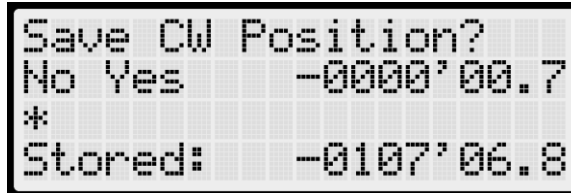

Figure 270: Save CW Position Menu

2.5.4 Miscellaneous, PI Labels, Real-Time Clock

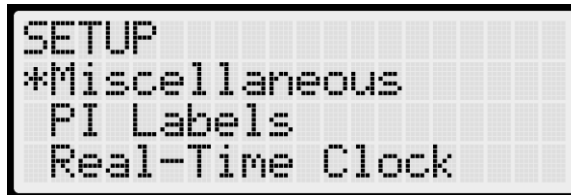

Figure 271: SETUP MENU –Miscellaneous, PI Labels, Real-Time Clock

2.5.4.1 Miscellaneous – Bypass Term Limits, Enable Const. Box, Max Run Time

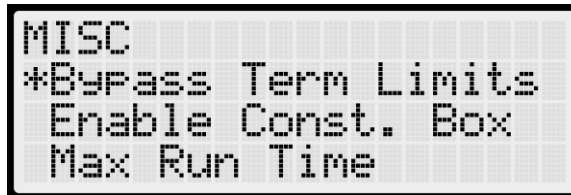

Figure 272: MISCELLANEOUS Menu – Bypass Term Limits, Enable Const. Box, Max Run Time

2.5.4.2 Miscellaneous – CT Insp. Req. IC, Dis. IdleTrvArrow, Enable Latches CC



Figure 273: MISCELLANEOUS Menu – CT Insp. Req. IC, Dis. IdleTrvArrow, Enable Latches CC

2.5.4.3 Miscellaneous – Fan & Light Timer, Ext. Fan Timer, Car To Lobby Flr



Figure 274: MISCELLANEOUS Menu – Fan & Light Timer, Ext. Fan Timer, Car To Lobby Flr

2.5.4.4 Miscellaneous – Arrival Update Time, Parking, OOS

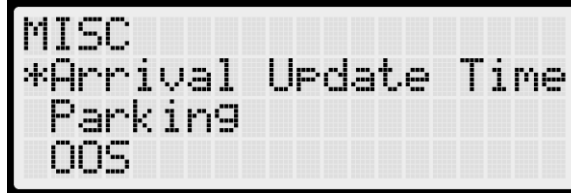

Figure 275: MISCELLANEOUS Menu – Arrival Update Time, Parking, OOS

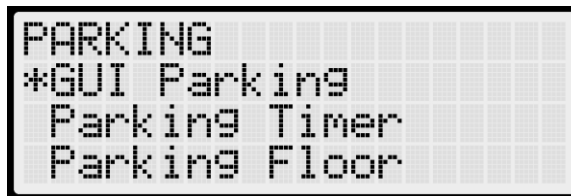

Figure 276: GUI PARKING Menu – GUI Parking, Parking Timer, Parking Floor



Figure 277: PARKING Menu – Parking Door Open



Figure 278: OOS Menu – Disable OOS, Hourly Fault Limit, Max Starts Per Minute



Figure 279: OOS Menu – Disable PI OOS

2.5.4.5 Miscellaneous – En. 3 Digit PI, Payment Passcode, Lockout Passcode



Figure 280: MISCELLANEOUS Menu – En. 3 Digit PI, Payment Passcode, Lockout Passcode

2.5.4.6 Miscellaneous – Dir. Counter Limit, Dir. Change Delay, Default

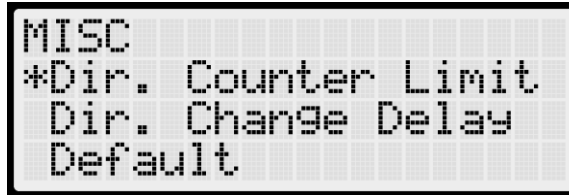

Figure 281: MISCELLANEOUS Menu – Dir. Counter Limit, Dir. Change Delay, Default



Figure 282: DEFAULT Menu – Default Floors, Default S-Curve, Default Run Timers

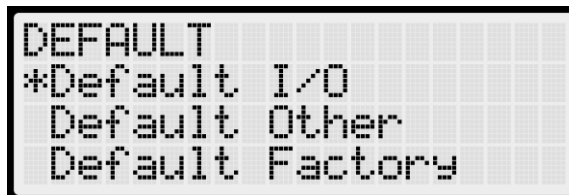

Figure 283: DEFAULT Menu – Default I/O, Default Other, Default Factory

2.5.4.7 PI Labels, Real-Time Clock

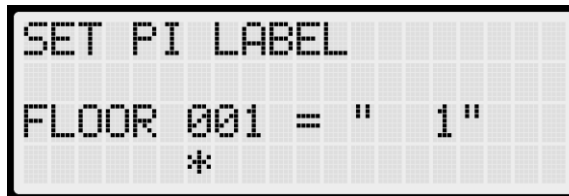

Figure 284: SET PI LABEL Menu



Figure 285: Real-Time Clock Menu

2.5.5 Group Setup, Flood



Figure 286: SETUP MENU – Group Setup, Flood

2.5.5.1 Group Setup – Group Car Index, Group Landing Offset, Dispatch Timeout

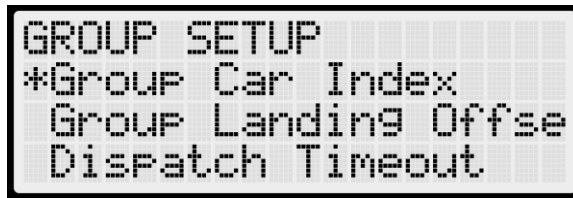

Figure 287: GROUP SETUP Menu – Group Car Index, Group Landing Offset, Dispatch Timeout

2.5.5.2 Group Setup – Dispatch Offline Timeout, XReg Cars, XReg Dest Timeout



Figure 288: GROUP SETUP Menu – Dispatch Offline Timeout, XReg Cars, XReg Dest Timeout

2.5.5.3 Group Setup – XReg Destination Offline Timeout, Enable Hall Security, Hall Security Mask



Figure 289: GROUP SETUP Menu – XReg Destination Offline Timeout, Enable Hall Security, Hall Security Mask



Figure 290: HALL SECURITY MASK Menu

2.5.5.4 Group Setup – Hall Security Map, Hall Call Mask



Figure 291: GROUP SETUP Menu – Hall Security Map, Hall Call Mask

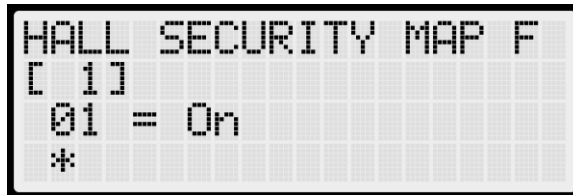

Figure 292: HALL SECURITY MAP FRONT Menu

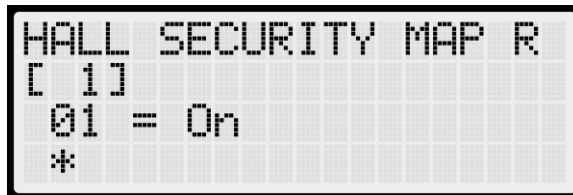

Figure 293: HALL SECURITY MAP REAR Menu

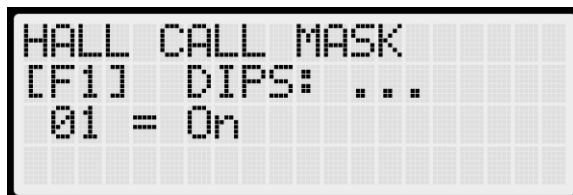

Figure 294: HALL CALL MASK Menu

2.5.5.5 Group Setup – Swing Call Mask, Hall Medical Mask, Hall Medical Rear Door Mask

```
GROUP SETUP
*Swing Call Mask
Hall Medical Mask
Hall Medical Rear D
```

Figure 295: GROUP SETUP Menu – Swing Call Mask, Hall Medical Mask, Hall Medical Rear Door Mask

```
HALL SWING MASK
[F1] DIPS: ...
01 = On
```

Figure 296: HALL SWING MASK Menu

```
HALL MEDICAL MASK
[F1] DIPS: ...
01 = On
```

Figure 297: HALL MEDICAL MASK Menu

```
HALL MEDICAL REAR DO
[F1] DIPS: ...
01 = Off
*
```

Figure 298: HALL MEDICAL REAR DOOR MASK Menu

2.5.5.6 Group Setup – Hall Rear Door Mask, Linked Hall Mask

```
GROUP SETUP
*Hall Rear Door Mask
Linked Hall Mask 1
Linked Hall Mask 2
```

Figure 299: GROUP SETUP Menu – Hall Rear Door Mask, Linked Hall Mask

```
HALL REAR DOOR MASK
[F1] DIPS: ...
01 = On
```

Figure 300: HALL REAR DOOR MASK Menu

```

CAR1 - ON [M]    <>
LM1: 0x03 LM4: 0x00
LM2: 0x0C
LM3: 0x00
    
```

Figure 301: Linked Hall Mask Status

2.5.5.7 Flood – Number of Floors, Okay To Run, Override Fire

```

FLOOD
*Number Of Floors
Okay To Run
Override Fire
    
```

Figure 302: FLOOD Menu – Number of Floors, Okay To Run, Override Fire

2.5.6 EMS, Sabbath, Swing

```

SETUP
*EMS
Sabbath
Swing
    
```

Figure 303: SETUP MENU – EMS, Sabbath, Swing

2.5.6.1 EMS - AllowPh2WithoutPh1, Exit Ph2 Any Floor, Fire Overrides Ph1

```

EMS
*AllowPh2WithoutPh1
Exit Ph2 Any Floor
Fire Overrides Ph1
    
```

Figure 304: EMS Menu – AllowPh2WithoutPh1, Exit Ph2 Any Floor, Fire Overrides Ph1

2.5.6.2 EMS - Ph1 Exit Delay, Ph2 Exit Delay, Ph1 Recall Floor

```

EMS
*Ph1 Exit Delay
Ph2 Exit Delay
Ph1 Recall Floor
    
```

Figure 305: EMS Menu – Ph1 Exit Delay, Ph2 Exit Delay, Ph1 Recall Floor

2.5.6.3 Sabbath – Key Enable Only, Timer Enable Only, Key or Timer Enable



Figure 306: SABBATH Menu – Key Enable Only, Timer Enable Only, Key or Timer Enable

2.5.6.4 Sabbath – Friday Start Time, Saturday End Time, Door Dwell Timer

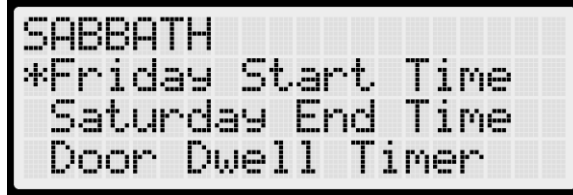

Figure 307: SABBATH Menu – Friday Start Time, Saturday End Time, Door Dwell Timer

2.5.6.5 Sabbath – Floors Opening, Destinations Up & Down



Figure 308: SABBATH Menu – Floors Opening, Destinations Up

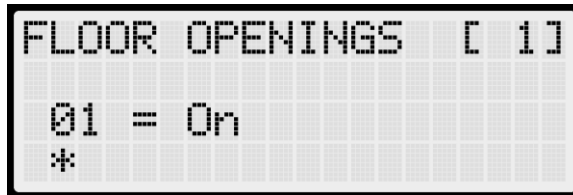

Figure 309: FLOOR OPENINGS (Front) Menu Example

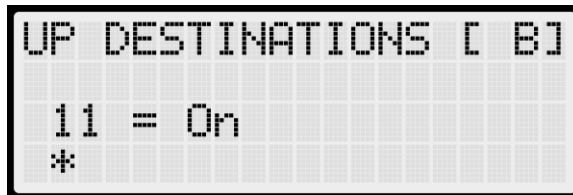

Figure 310: UP DESTINATIONS Menu

```
SABBATH
Floors Opening (R)
Destinations UP
*Destinations Down
```

Figure 311: SABBATH Menu – Destinations Down

```
DN DESTINATION [LL]

01 = On
*
```

Figure 312: DOWN DESTINATION Menu

**2.5.6.6 Swing – Calls Enable Swing, Stay In Group, Idle Timer**

```
SWING
*Calls Enable Swing
Stay In Group
Idle Timer
```

Figure 313: SWING Menu – Calls Enable Swing, Stay In Group, Idle Timer

**2.5.7 Attendant, E-Power, Hydro**

```
SETUP
*Attendant
E-Power
Hydro
```

Figure 314: SETUP MENU – Attendant, E-Power, Hydro

**2.5.7.1 Attendant – Dispatch Timeout, Buzzer Time**

```
ATTENDANT
*Dispatch Timeout
Buzzer Time
```

Figure 315: ATTENDANT Menu – Dispatch Timeout, Buzzer Time

2.5.7.2 E-Power – Num Active Cars, Priority Car, Pretransfer Stall

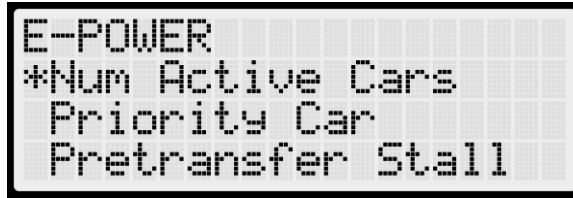

Figure 316: E-POWER Menu – Num Active Cars, Priority Car, Pretransfer Stall

2.5.7.3 Hydro – Valve Type Select, Secondary Valve Board, Third Valve Board

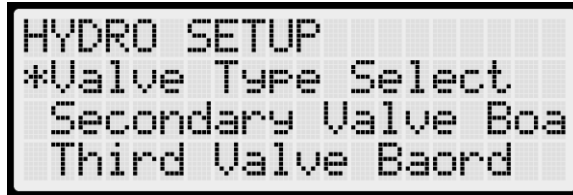

Figure 317: HYDRO SETUP Menu – Valve Type Select, Secondary Valve Board, Third Valve Board

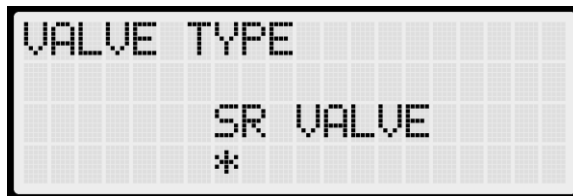

Figure 318: VALVE TYPE Menu

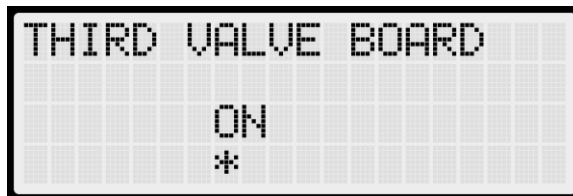

Figure 319: THIRD VALVE BOARD Menu



Figure 320: HYDRO SETUP Menu – Fourth Valve Board

2.5.7.4 Hydro – Soft Starter

```
HYDRO SETUP
Fourth Valve Board
*Soft Starter
Med Max Run Dist.
```

Figure 321: HYDRO SETUP Menu – Soft Starter

```
SOFT STARTER
*Primary
Secondary
Third
```

Figure 322: SOFT STARTER Menu – Primary, Secondary, Third

```
PRIMARY
*Ramp Up Time
UMax
Over Current
```

Figure 323: PRIMARY Menu – Ramp Up Time, Vmax, Over Current

```
PRIMARY
UMax
Over Current
*Over Temperature
```

Figure 324: PRIMARY Menu – Over Temperature

```
SECONDARY
*Enable Secondary
Ramp Up Time
UMax
```

Figure 325: SECONDARY Menu – Enable Secondary, Ramp Up Time, Vmax

```
SECONDARY
UMax
*Over Current
Over Temperature
```

Figure 326: SECONDARY Menu – Over Current, Over Temperature



Figure 327: THIRD Menu – Enable Third

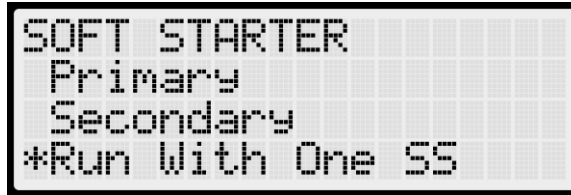

Figure 328: SOFT STARTER Menu – Run With One Soft Starter

**2.5.7.5 Hydro – Med Max Run Distance, Low Max Run Distance, Level Max Run Distance**



Figure 329: HYDRO SETUP Menu – Med Max Run Dist., Low Max Run Dist., Level Max Run Dist.

**2.5.7.6 Hydro – NTS Buff Distance, Destination Offset**



Figure 330: HYDRO SETUP Menu – NTS Buff Distance, Destination Offset

**2.5.7.7 Hydro – Relevel Offset, Speed Thresholds**



Figure 331: HYDRO SETUP Menu – Relevel Offset, Speed Thresholds

```
SPEED THRESHOLD
7'01"UP 1'07"dn
1 = 00257 fPM
*
```

Figure 332: SPEED THRESHOLD Menu

2.5.7.8 Hydro – Slowdown Distance, Battery Test Time, Jack Resync

```
HYDRO SETUP
Slowdown Dist. DN
Battery Test Time
*Jack Resync
```

Figure 333: HYDRO SETUP Menu – Slowdown Distance, Battery Test Time

```
SLOWDOWN DIST UP
@ 105 fPM 2'09"
2 = 01710
*
```

Figure 334: SLOWDOWN DISTANCE UP Menu

```
SLOWDOWN DIST DOWN
@ 105 fPM 3'06"
2 = 02174
*
```

Figure 335: SLOWDOWN DISTANCE DOWN Menu

```
JACK RESYNC
*Jack Resync Time
Ignore Calls
Duration
```

Figure 336: JACK RESYNC Menu – Jack Resync Time, Ignore Calls, Duration

```
JACK RESYNC
*Frequency
Activate JackResync
```

Figure 337: JACK RESYNC Menu – Frequency, Activate JackResync

2.5.7.9 Hydro – Viscosity, DISA NTS Alarm, TSRD Distance



Figure 338:HYDRO SETUP Menu – Viscosity, DISA NTS Alarm, TSRD Distance



Figure 339: VISCOSITY Menu – Allow Calls, Cycles Allowed, Run Time 1min



Figure 340: VISCOSITY Menu – Rest Time 1min

2.5.7.10 Hydro – Hydro Speed Setup, Adaptive Slowdown



Figure 341:HYDRO SETUP Menu – Hydro Speed Setup, Adaptive Slowdown



Figure 342: HYDRO SPEED SETUP Menu – Up Adjustment, Down Adjustment, Gen Thrhlds & Dist

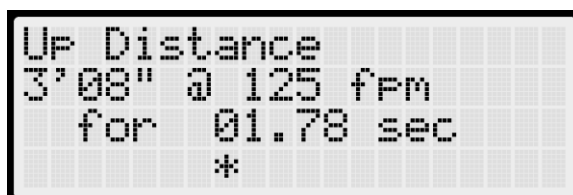

Figure 343: Up Distance Menu



Figure 344: Down Distance Menu

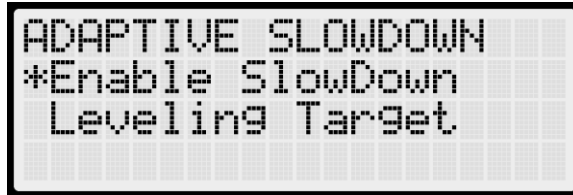

Figure 345: ADAPTIVE SLOWDOWN Menu – Enable Slowdown, Leveling Target

### 2.5.8 Access Code

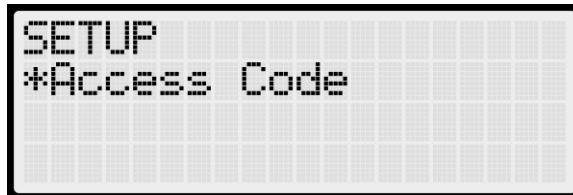

Figure 346: SETUP MENU – Access Code

#### 2.5.8.1 Access Code – CCB Timer, Enable Front Doors, Enable Rear Doors

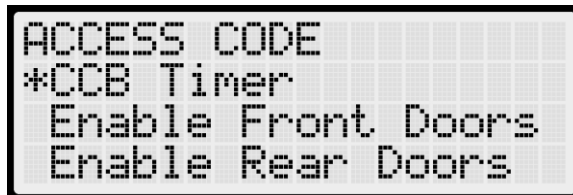

Figure 347: ACCESS CODE Menu – CCB Timer, Enable Front Doors, Enable Rear Doors

#### 2.5.8.2 Access Code – Access Codes, Offset Floors

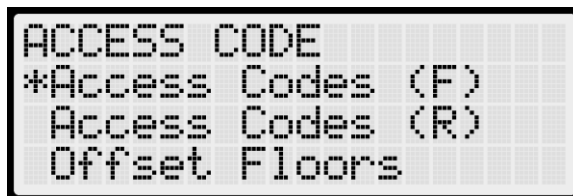

Figure 348: ACCESS CODE Menu – Access Codes, Offset Floors

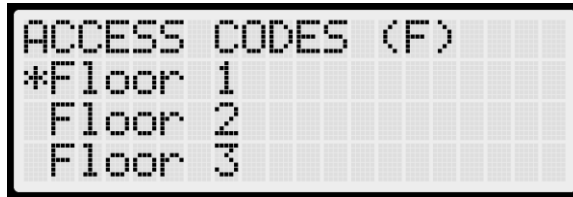

Figure 349: ACCESS CODES FRONT Menu Example – Floor Number

## 2.6 Debug

The DEBUG menu contains options used for system testing and diagnostics.

### 2.6.1 Enter Car Calls, Enter Hall Calls, Enter Door Command

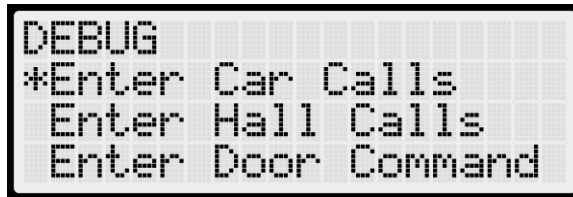

Figure 350: DEBUG Menu – Enter Car Calls, Enter Hall Calls, Enter Door Command



Figure 351: ENTER CAR CALLS Menu – Front or Rear



Figure 352: ENTER CAR CALL Menu



Figure 353: Hall Call Menu

Refer to the **System Configurations** for further details on the Hall Call menu.

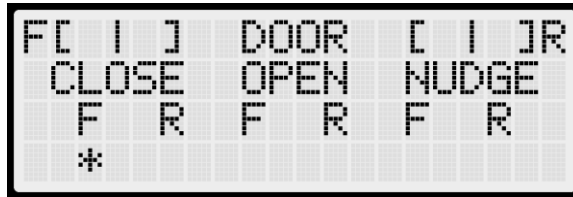

Figure 354: Enter Door Command Menu (Front and Rear Doors)



Figure 355: Enter Door Command Menu (Front Doors Only)

### 2.6.2 Edit Parameters, View Network Packet, View Group Packets

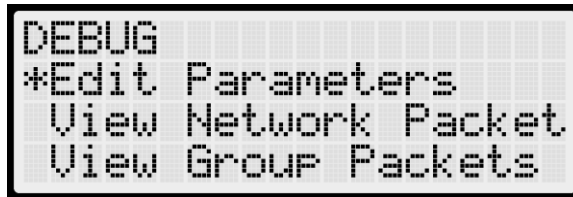

Figure 356: DEBUG Menu – Edit Parameters, View Network Packet, View Group Packets



Figure 357: PARAMETER EDIT Menu – Hexadecimal or Decimal Format



Figure 358: EDIT AS BINARY Menu



Figure 359: EDIT AS HEXADECIMAL Menu

```

EDIT AS DECIMAL
MR IN 1
16-0000=01280
*
    
```

Figure 360: EDIT AS DECIMAL Menu

```

(LSB) 07 05 00 00
      85 85 93 D8
PACKET 100
      *   RX:00051
    
```

Figure 361: Network Packet

```

(LSB) 00 00 00 00
      00 00 00 00
PACKET 100
      *   RX:00000
    
```

Figure 362: Group Packet

### 2.6.3 View Debug Data, Acceptance Test, EmergencyBitmap

```

DEBUG
*View Debug Data
  Acceptance Test
  EmergencyBitmap
    
```

Figure 363: DEBUG Menu – View Debug Data, Acceptance Test, EmergencyBitmap

```

View Debug Data
004 (MR CAN4)
*
ERR:00005 Util:2%
    
```

Figure 364: View Debug Data Menu

```

Select Acceptance Te
Idle
  Inactive
*
    
```

Figure 365: SELECT ACCEPTANCE TEST Menu

```
EMERGENCY STATUS
[X] FireI_RecalltoAl
[ ] FireI_FlashHat
[ ] FireI_ArmReset
```

Figure 366: EMERGENCY STATUS Menu

**2.6.4 Module Statuses, Car Data, Car Destinations**

```
DEBUG
*Module Statuses
  Car Data
  Car Destinations
```

Figure 367: DEBUG Menu – Module Statuses, Car Data, Car Destinations

**2.6.4.1 Module Status – Motion Status, Pattern Data, Auto Status**

```
MODULE STATUS
  Motion Status
  Pattern Data
*Auto Status
```

Figure 368: MODULE STATUS Menu – Motion Status, Pattern Data, Auto Status

```
Auto Operation Statu
State: Idle
```

Figure 369: Auto Operation Status Menu

**2.6.4.2 Module Status – Recall Status, Fire Status, Counterweight Status, Floor Learn Status**

```
MODULE STATUS
*Recall Status
  Fire Status
  Counterweight Statu
```

Figure 370: MODULE STATUS Menu – Recall Status, Fire Status, Counterweight Status

```
Recall Status  
State: Unknown
```

Figure 371: Recall Status Menu

```
Fire Status  
Active: Fire I  
FireII: Off
```

Figure 372: Fire Status Menu

```
Counterweight Status  
State: Unknown
```

Figure 373: Counterweight Status Menu

```
MODULE STATUS  
Fire Status  
Counterweight Statu  
*Floor Learn Status
```

Figure 374: MODULE STATUS Menu – Floor Learn Status

```
Floor Learn Status  
State: Not On Learn
```

Figure 375: Floor Learn Status Menu

2.6.4.3 Car Data

Refer to the **System Configurations** for further details on the Car Data menu.

```

CAR1 - ON [M] >
A-NORM - IN GRP ISR
C-10 D-12 R-11 M-UP
[>|>] [>|<] P-DN
    
```

Figure 376: Car Data Overview Status

```

CAR1 - ON [M] <>
HMF: 0x00000003
HMR: 0x0000000C
HML: 0x0000000F
    
```

Figure 377: Hall Mask Status

```

CAR1 - ON [M] <>
OMF1: 0xFFFFFFFF
OMF2: 0x00000001
OMF3: 0x00000000
    
```

Figure 378: Front Opening Map Status

```

CAR1 - ON [M] <>
OMR1: 0xFFFFFEE5
OMR2: 0xFFFFFFFF
OMR3: 0xFFFFFFFF
    
```

Figure 379: Rear Opening Map Status

```

CAR1 - ON [M] <>
SMF1: 0xFFFFFFFF
SMF2: 0xFFFFFFFF
SMF3: 0xFFFFFFFF
    
```

Figure 380: Front Security Map Status

```

CAR1 - ON [M] <>
SMR1: 0xFFFFFFFF
SMR2: 0x00000001
SMR3: 0x00000000
    
```

Figure 381: Rear Security Map Status

```

CAR1 - ON [M] <>
LM1: 0x03 LM4: 0x00
LM2: 0x0C
LM3: 0x00
    
```

Figure 382: Linked Hall Mask Status

```

CAR1 - ON [M] <>
HSO-F1: 0x00000003
HSO-F2: 0x00000000
HSO-F3: 0x00000000
    
```

Figure 383: Front Hall Security Map Status

```

CAR1 - ON [M] <>
HSO-R1: 0x00000004
HSO-R2: 0x00000000
HSO-R3: 0x00000000
    
```

Figure 384: Rear Hall Security Map Status

```

CAR1 - ON [M] <>
HSMF: 0x03
HSMR: 0x04
BYP: ON
    
```

Figure 385: Front and Rear Hall Security Mask Status

```

CAR1 - ON [M] >
F2F: 006
CCD: 003
HCD: 006
    
```

Figure 386: Dispatching Timers Status

```

CAR1 - ON [M] <>
bVIP: 000
bCarCapture: 000
bCarReady: 000
    
```

Figure 387: VIP Flags Status

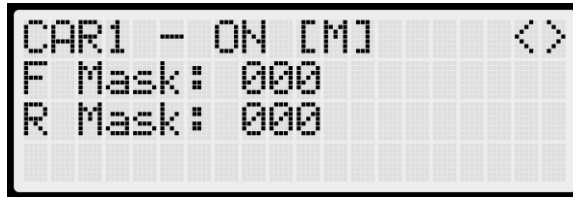

Figure 388: VIP Mask Status



Figure 389: Front Car Call Enable Bitmap Status



Figure 390: Rear Car Call Enable Bitmap Status Menu

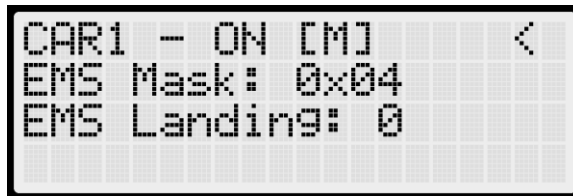

Figure 391: Emergency Medical Call Mask and Landing

#### 2.6.4.4 Car Destination

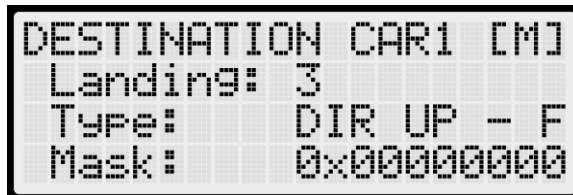

Figure 392: DESTINATION Menu

Refer to the **System Configurations** for further details on the Car Destination menu.

2.6.5 Run Counter, DebugRuns, XReg Destination



Figure 393: DEBUG Menu – Run Counter, DebugRuns, XReg Destination

2.6.5.1 Run Counter



Figure 394: RUN COUNTER Menu

2.6.5.2 DebugRuns – Dwell Time, Terminal to Terminal, Floor To Floor



Figure 395: DEBUGRUNS Menu – Dwell Time, Terminal to Terminal, Floor To Floor

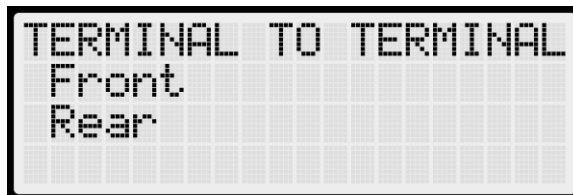

Figure 396: TERMINAL TO TERMINAL Menu – Front or Rear

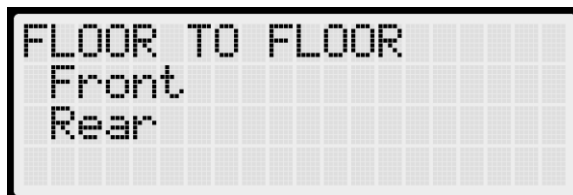

Figure 397: FLOOR TO FLOOR Menu – Front or Rear

2.6.5.3 DebugRuns – Random, Hall Random Runs, Time & Counts, Clear Debug Runs

```
DEBUGRUNS
*Random
Hall Random Runs
Time & Counts
```

Figure 398: DEBUGRUNS Menu – Random, Hall Random Runs, Time & Counts

```
RANDOM
Front
Rear
```

Figure 399: RANDOM Menu – Front or Rear

```
ELAPSED TIME (MINS)
0
TRIP COUNTS
0
```

Figure 400: ELAPSED TIME & TRIP COUNTS Menu

```
DEBUGRUNS
*Clear Debug Runs
```

Figure 401: DEBUGRUNS Menu – Clear Debug Runs

2.6.5.4 XReg Destination

```
DESTINATION CAR4 [ ]
Landing: 1
Type: CC - Front
Mask: 0x00000000
```

Figure 402: DESTINATION Menu

2.6.6 XReg Data, SH Dynamic Car Parking, SH Predictive Car Parking



Figure 403: DEBUG Menu – XReg Data, SH Dynamic Car Parking, SH Predictive Car Parking

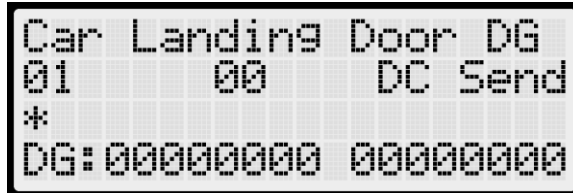

Figure 404: Car Landing Door DG Menu

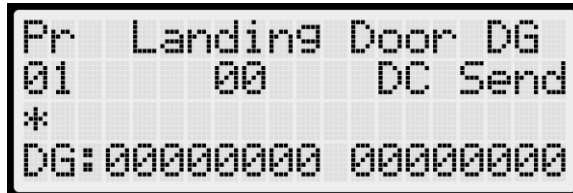

Figure 405: Pr Landing Door DG Menu

2.6.7 SH Remote Commands, View Module Data

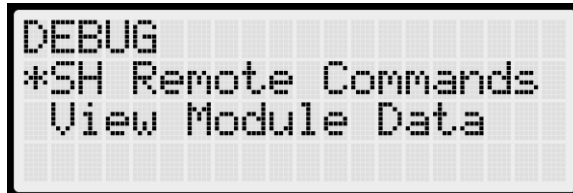

Figure 406: DEBUG Menu – SH Remote Commands, View Module Data

2.6.7.1 SH Remote Commands – CC Security, HC Security, Virtual Inputs

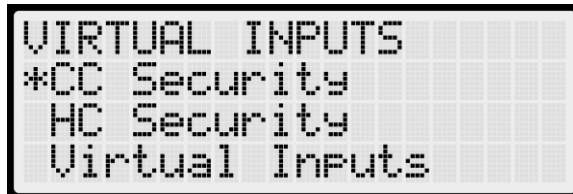

Figure 407: VIRTUAL INPUTS Menu – CC Security, HC Security, Virtual Inputs

```
SECURE CAR CALLS
Front
Rear
```

Figure 408: SECURE CAR CALLS Menu – Front or Rear

```
Secure Car Front
FLR 1-32 :000000009
FLR 33-65:00000000
FLR 66-96:00000000
```

Figure 409: Secure Car Front Menu

```
Secure Car Rear
FLR 1-32 :00000000
FLR 33-64:00000000
FLR 65-96:00000000
```

Figure 410: Secure Car Rear Menu

```
SECURE HALL CALLS
Front
Rear
```

Figure 411: SECURE HALL CALLS Menu – Front or Rear

```
Secure Front HC
FLR 1-32 :000000011
FLR 33-64:00000000
FLR 65-96:00000000
```

Figure 412: Secure Front Hall Call Menu

```
Secure Rear HC
FLR 1-32 :000000001
FLR 33-65:00000010
FLR 66-96:00000000
```

Figure 413: Secure Rear Hall Call Menu

```

Virtual Input
[ ] Latch New CC
[ ] E-Power Manual
[ ] E-Power Select 1
    
```

Figure 414: Virtual Input Menu

2.6.7.2 SH Remote Commands – Recall Floor/Door, Door Command Landing

```

VIRTUAL INPUTS
*Recall Floor/Door
  Door Command Landin
    
```

Figure 415: VIRTUAL INPUTS Menu – Recall Floor/Door, Door Command Landing

```

Recall Floor/Door
Floor:00
Door :00
    
```

Figure 416: Recall Floor/Door Menu

```

Door Command Landing
Floor:000
    
```

Figure 417: Door Command Landing Menu

2.6.7.3 View Module Data

```

VIEW MODULE DATA
00000 (NONE) usec
*
    
```

Figure 418: VIEW MODULE DATA Menu

*Page intentionally left blank.*

---

# **LIST OF ABBREVIATIONS & REFERENCES**

---

## List of Abbreviations

<b>ADA</b>	Americans with Disabilities Act
<b>CCB</b>	Car Call Button
<b>COP</b>	Car Operating Panel
<b>CT</b>	Car Top
<b>DC</b>	Door Close
<b>DO</b>	Door Open
<b>DOL</b>	Door Open Limit
<b>DZ</b>	Door Zone
<b>EMS</b>	Emergency Medical Services
<b>GSW</b>	Gate Switch
<b>GUI</b>	Graphical User Interface
<b>HA</b>	Hoistway Access
<b>MR</b>	Machine Room
<b>NTS</b>	Normal Terminal Stop
<b>ODL</b>	Overspeed Debounce Limit
<b>OMF</b>	Opening Map Front
<b>OMR</b>	Opening Map Rear
<b>OOS</b>	Out Of Service
<b>PI</b>	Position Indicator
<b>SM</b>	Start Motor
<b>SMF</b>	Security Mask Front
<b>SMR</b>	Security Mask Rear
<b>SRU</b>	Smartrise Universal
<b>TSRD</b>	Terminal Stopping Reducing Distance
<b>UI</b>	User Interface

## References

**Smartrise's Hydro:Evolved Manuals**

<https://www.smartrise.us/material/3/hydro:evolved-material>

**Smartrise's Hydro:Evolved Training Videos**

<https://www.smartrise.us/lectures/5/c4-training-videos>